

EDAC



WATERPROOF CONNECTORS



IP Rated Wire-to-Wire, Wire-to-Board

Connect with Us...Experience Makes the Difference



EDAC's waterproof Wire to Wire and Wire to Board series were designed for both extreme moisture and non-submersion applications supporting both low-level signal and power applications up to 12A and 300V.

Major applications include automotive, commercial and recreational vehicles, outdoor lighting, appliances, marine & aftermarket products, solar power installations, industrial equipment, process control, construction equipment, outdoor broadcast systems and portable devices.

EDAC's waterproof series come in pitch sizes ranging from 2.0mm to 5.9mm and feature silicone rubber gaskets either pre-installed in all-in-one plugs and receptacle housings or loose and available in a range of sizes to accommodate wire from 28AWG to 14AWG with either thin or standard wire insulation. Operating temperature range across the whole series of -40°C to +105°C.

Some of the unique features of EDAC's waterproof series include integral locking and double locking tabs designed to prevent accidental disengagements, keying system to prevent mismatching, circuit sizes from 1 to 9 positions and visual confirmation of proper sealing.

Application tooling available includes hand tools for prototype and small builds to fully automated presses and applicators for high production applications. EDAC also offers the whole series in custom cables already fully assembled.

QUICK REFERENCE GUIDE

Series	Type	Current Rating	Pitch	Pages
560	Wire to Wire	3A	2.5mm	2-3
560	Wire to Board	3A	2.5mm	2-3
566	Wire to Wire	2A	2.0mm	4-5
566	Wire to Board	2A	2.0mm	4-5
567	Wire to Wire	8A	5.9mm	6-7
568	Wire to Wire	12A	n.a.	8
572	Wire to Wire	10A	5.8mm	9-10
572	Wire to Wire	10A	5.8mm	9-10
Assembly Instructions	Assembly instructions for 560 and 572 Series			11-12
Tools	Hand Crimp Tool, Ejection Tool and Auto-Crimp Machine			13

HOW TO USE THIS PRODUCT GUIDE

- Using the quick reference guide above, select the type of solution you need and proper current rating for your application and refer to the section of the product guide with the series you have selected.
- Select the part with the appropriate number of contacts required for your application and the mating connector if required. (Quantities shown are standard pack quantities)
- If applicable, using the Wire Seal Selection Guide in the series section, select the seal required for the wire gauge to be used in the application.
- Contacts are supplied on the reel & bulk. See specific series section for more information on the available standard quantities.

Custom assemblies are available in all series directly from EDAC, manufactured to your specifications. Contact EDAC or your local representative for more information.

WIRE GAUGE REFERENCE GUIDE

Gauge / AWG#	Sectional Area	Gauge / AWG#	Sectional Area
10	5.2mm ²	24	0.21mm ²
12	3.3mm ²	26	0.13mm ²
14	2.0mm ²	28	0.08mm ²
16	1.31mm ²	30	0.05mm ²
18	0.83mm ²	32	0.03mm ²
20	0.52mm ²	34	0.02mm ²
22	0.33mm ²	36	0.01mm ²



- 2.5mm Pitch, Rated Current: 3A max
- Fully Waterproof with Double Latch Solution
- Available in Wire-to-Wire and Wire-to-Board Options
- Seals Preassembled into Housing; No External Sealing Required available in 2, 3, or 5 Positions
- True Crimp and Poke Solution
- Waterproofing Cap available to cover holes of wire seal
- Internal Polarization to Prevent Mismatching
- Available with wire already installed
- Waterproof Grade IP67 Certified



Specifications:

No. of Positions	2, 3, 5P
Pitch	2.5mm
Rated Voltage	250V
Rated Current	3A max
Withstanding Voltage	1000V AC (rms)
Contact Resistance	15 mΩ max
Insulation Resistance	1000 MΩ min./DC500V
Temperature Range	-40°C to +105°C
PCB Thickness	1.6mm

Materials:

Crimp & Poke	Housing	PBT, UL 94V-0
	Contact	Phosphor Bronze
PCB Header	Housing	PBT with Glass, UL 94V-0
	Contact	Brass
Contact Plating		Tin Plating
Wire & Housing Seals		Silicone Rubber
Waterproofing Cap		PBT, UL 94V-0

Waterproofing Cap:

Part No.
565-200-100



Crimp Contact:

Male Contact (Pin)			
Part No	AWG#	Ins. Dia.	Pcs/Reel
565-290-731	20-22	Max. Ø1.7	8,000
565-290-711	22-28	Max. Ø1.6	8,000

**Crimp Contacts are also available in strips of 60pcs. Contact EDAC for more information.

Female Contact (Socket)			
Part No	AWG#	Ins. Dia.	Pcs/Reel
565-290-741	20-22	Max. Ø1.7	8,000
565-290-721	22-28	Max. Ø1.6	10,000

**Wire seals, housing seals and retainers are already pre-assembled in the connector.

Rear Gasket (Wire Seal):

Applicable Contact	Wire O.D.	Color
565-290-711	Ø1.00 to Ø1.30	Yellow
565-290-721	Ø1.30 to Ø1.70	Orange

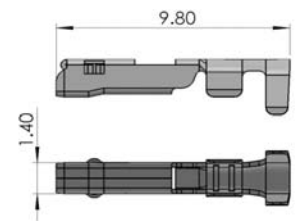
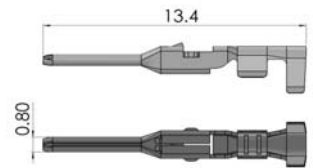

Ordering Code: 560-002-000-110

SERIES: _____
560 - WIRE TO WIRE
WIRE TO BOARD

NO. OF CONTACTS: _____
002 - 2 CONTACTS
003 - 3 CONTACTS
005 - 5 CONTACTS

CONTACT CODE: _____
000 - NO CONTACTS (ONLY FOR CRIMP CONTACTS)
420 - BOARD MOUNT CONTACTS

STYLE: _____
101 - WHITE MALE HOUSING (ONLY FOR BOARD MOUNT CONTACTS)
301 - BLUE MALE HOUSING (ONLY FOR BOARD MOUNT CONTACTS)
110 - WHITE MALE HOUSING FOR WIRE INSULATION Ø1.00 TO Ø1.30
310 - BLUE MALE HOUSING FOR WIRE INSULATION Ø1.00 TO Ø1.30
111 - WHITE MALE HOUSING FOR WIRE INSULATION Ø1.30 TO Ø1.70
311 - BLUE MALE HOUSING FOR WIRE INSULATION Ø1.30 TO Ø1.70
210 - WHITE FEMALE HOUSING FOR WIRE INSULATION Ø1.00 TO Ø1.30
410 - BLUE FEMALE HOUSING FOR WIRE INSULATION Ø1.00 TO Ø1.30
211 - WHITE FEMALE HOUSING FOR WIRE INSULATION Ø1.30 TO Ø1.70
411 - BLUE FEMALE HOUSING FOR WIRE INSULATION Ø1.30 TO Ø1.70

Assembly Layout

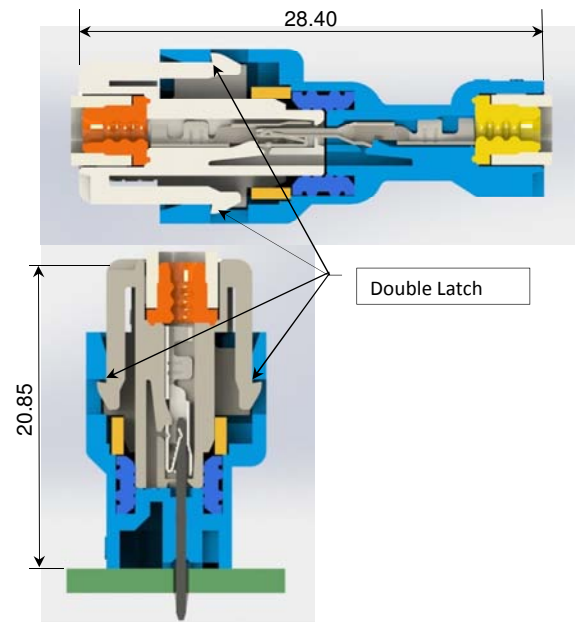

Wire to Wire / Wire to Board 2.5mm Pitch

Male Housing:

560-002-000-XXX

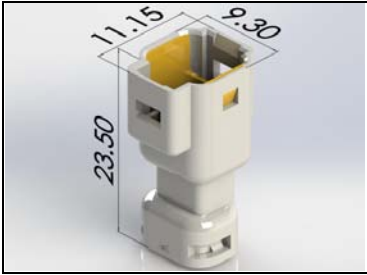

560-003-000-XXX

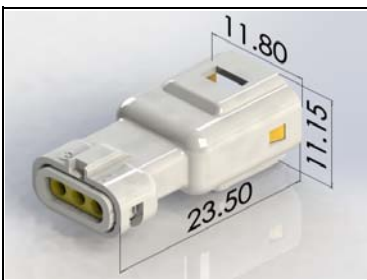

560-005-000-XXX



Female Housing:

560-002-000-XXX



560-003-000-XXX

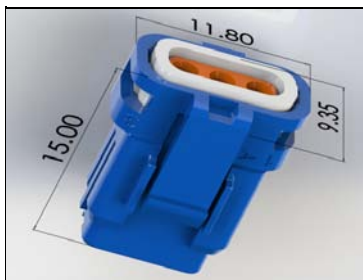

560-005-000-XXX



PCB Header

560-002-420-XXX

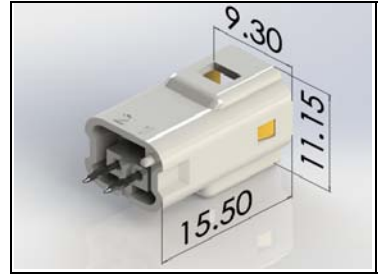

560-003-420-XXX

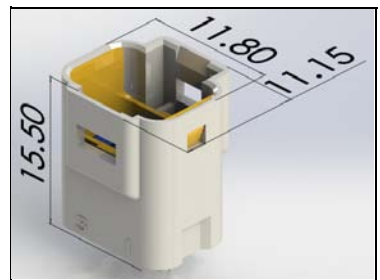

560-005-420-XXX

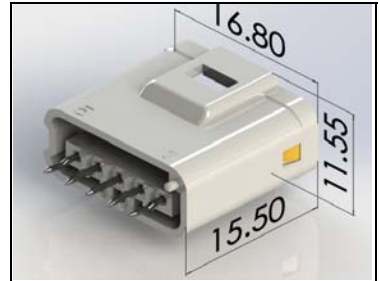

Male Housing:

Ø Wire Insulation	Housing Color	XXX
Ø1.00 to Ø1.30	White	110
	Blue	310
Ø1.30 to Ø1.70	White	111
	Blue	311

Female Housing:

Ø Wire Insulation	Housing Color	XXX
Ø1.00 to Ø1.30	White	210
	Blue	410
Ø1.30 to Ø1.70	White	211
	Blue	411

PCB Header:

Housing Color	XXX
White	101
Blue	301

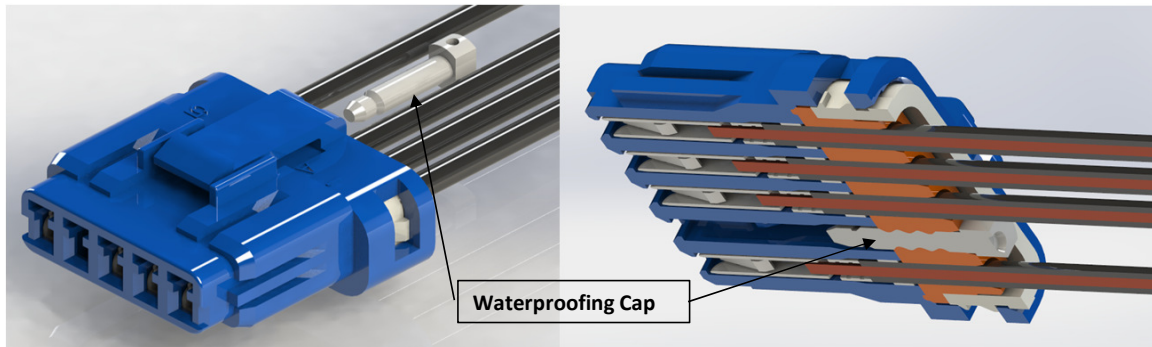

NOTE: Waterproofing Cap is installed at the wire seal end to cover the unused holes.



- 2.0mm Pitch, Rated Current: 2A max
- Fully Waterproof Solution available in 2, 3, 4, or 6 Positions (2 and 3 Positions Only for Wire to Board)
- Available in Wire-to-Wire and Wire-to-Board Options
- Seals preassembled into housing; no external sealing required
- True Crimp and Poke Solution
- Waterproofing cap available to cover holes of wire seal
- Available with wire already installed
- Waterproof Grade IP67 Certified



Specifications:

No. of Positions	2, 3, 4, or 6P
Pitch	2.0mm
Rated Voltage	250V
Rated Current	2A max
Withstanding Voltage	1000V AC (rms)
Contact Resistance	10 mΩ max
Insulation Resistance	1000 MΩ min./DC500V
Temperature Range	-40°C to +105°C
PCB Thickness	1.6mm

Materials:

Crimp & Poke	Housing	PBT, UL 94V-0
	Contact	Phosphor Bronze
PCB Header	Housing	PBT with Glass, UL 94V-0
	Contact	Brass
Contact Plating	Tin Plating	
Wire & Housing Seals	Silicone Rubber	
Waterproofing Cap	PBT, UL 94V-0	

Waterproofing Cap:

Part No
566-200-100



Crimp Contact:

Male Contact (Pin)			
Part No	AWG#	Ins. Dia.	Pcs/Reel
566-290-711	22-28	Ø1.0~Ø1.5	12,000

**Crimp Contacts are also available in strips of 60pcs. Contact EDAC for more information.

Female Contact (Socket)			
Part No	AWG#	Ins. Dia.	Pcs/Reel
566-290-721	22-28	Ø1.0~Ø1.5	12,000

**Wire seals and housing seals are already pre-assembled in the connector.

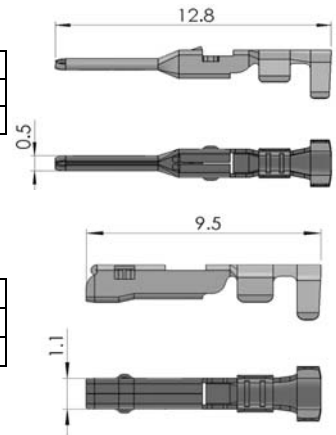

Rear Gasket (Wire Seal):

Applicable Contact	Wire O.D.	Color
566-290-711	Ø1.00 to Ø1.25	Light Blue
566-290-721	Ø1.25 to Ø1.50	Orange



Ordering Code: **566-002-000-710**

SERIES: _____
566, WIRE TO WIRE
WIRE TO BOARD

NO. OF CONTACTS: _____
002 - 2 CONTACTS
003 - 3 CONTACTS
004 - 4 CONTACTS
006 - 6 CONTACTS

CONTACT CODE: _____
000 - NO CONTACTS (ONLY FOR CRIMP CONTACTS)
421 - BOARD MOUNT CONTACTS (PCB) ONLY FOR
2 & 3 PIN SIZE

STYLE: _____
701 - BLACK MALE HOUSING (ONLY FOR BOARD MOUNT CONTACTS)
710 - BLACK MALE HOUSING FOR WIRE INSULATION Ø1.00 TO Ø1.25
711 - BLACK MALE HOUSING FOR WIRE INSULATION Ø1.25 TO Ø1.50
810 - BLACK FEMALE HOUSING FOR WIRE INSULATION Ø1.00 TO Ø1.25
811 - BLACK FEMALE HOUSING FOR WIRE INSULATION Ø1.25 TO Ø1.50

Assembly Layout

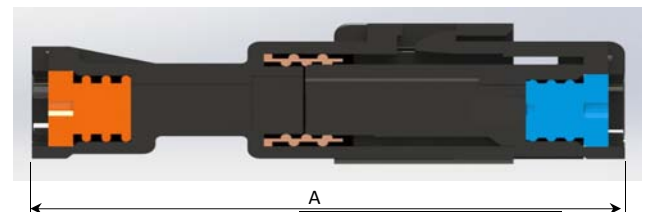

PIN SIZE	A (mm) LENGTH
2P, 3P, 4P	28.85
6P	29.05

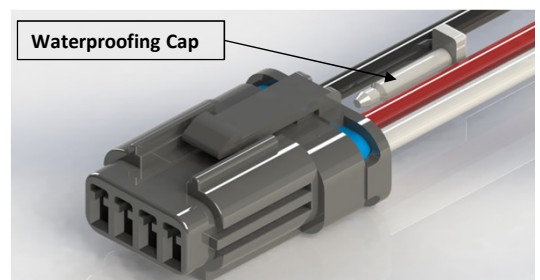

NOTE: Waterproofing Cap is installed at the wire seal end to cover the unused holes.

Male Housing:

566-002-000-XXX



566-003-000-XXX



566-004-000-XXX

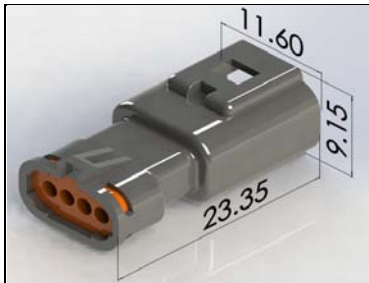

566-006-000-XXX



Male Housing:

Ø Wire Insulation	Housing Color	XXX
Ø1.00 to Ø1.25	Black	710
Ø1.25 to Ø1.50	Black	711

Female Housing:

566-002-000-XXX

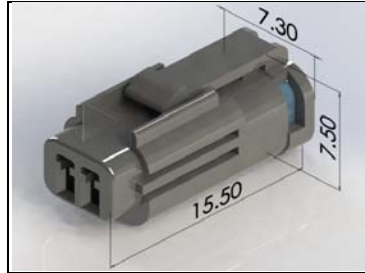

566-003-000-XXX

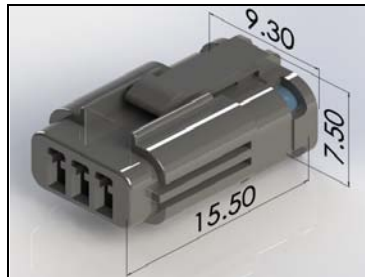

566-004-000-XXX

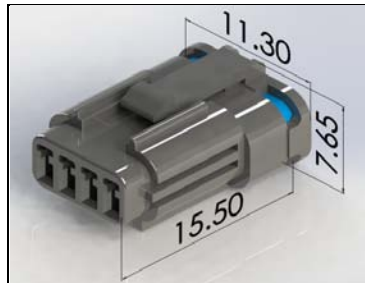

566-006-000-XXX

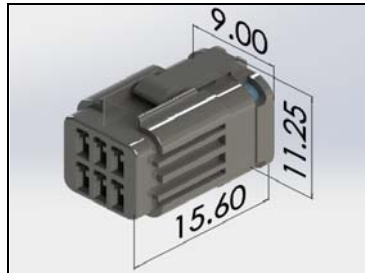

Female Housing:

Ø Wire Insulation	Housing Color	XXX
Ø1.00 to Ø1.25	Black	810
Ø1.25 to Ø1.50	Black	811

PCB Header

566-002-421-701

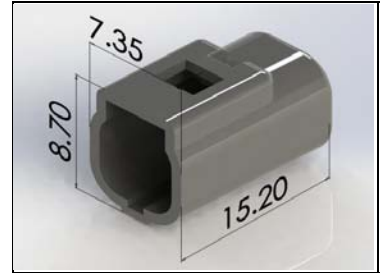

566-003-421-701

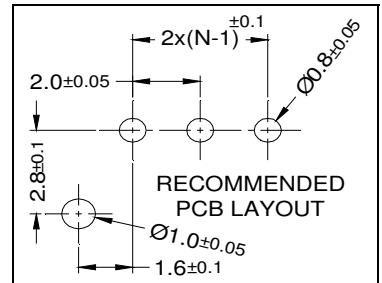
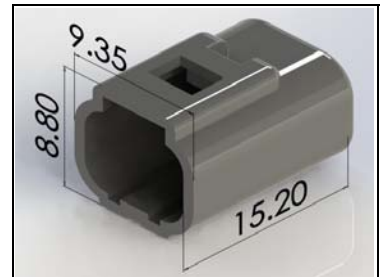

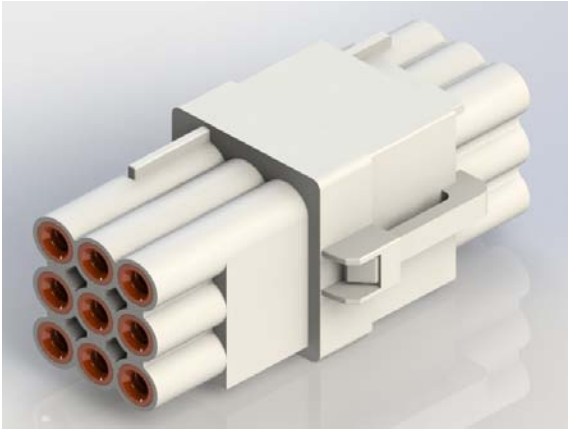

- 5.0mm x 5.9mm Pitch, Rated Current: 8A max
- Splashproof Solution available in 1, 2, 3, 4, 6, or 9 positions
- Available in Wire-to-Wire Options
- True Crimp and Poke Solution with various sized wire seals available
- Available with wire already installed
- Splash Proof Grade IP52 (JIS C0920) Certified



Specifications:

No. of Positions	1, 2, 3, 4, 6, or 9P
Pitch	5.0mm x 5.9mm
Rated Voltage	300V
Rated Current	8A max
Withstanding Voltage	1700V AC (rms)
Contact Resistance	10 mΩ max
Insulation Resistance	1000 MΩ min./DC500V
Temperature Range	-40°C to +105°C

Materials:

Housing	PBT, UL 94V-0
Contact	Ph. Brz. or Brass
Contact Plating	Tin Plating
Wire Seal	Silicone Rubber

Crimp Contact:

Male Contact (Pin)			
Part No (Material)	AWG#	Ins. Dia.	Pcs/Reel
570-290-751 (Brass)	14	Max. Ø3.1	4,000
570-291-731 (Ph. Brz.)	20-16	Max. Ø3.1	4,000
570-290-731 (Brass)	20-16	Max. Ø3.1	4,000
570-290-711 (Brass)	22-20	Max. Ø2.7	4,000

Female Contact (Socket)			
Part No (Material)	AWG#	Ins. Dia.	Pcs/Reel
570-290-761 (Brass)	14	Max. Ø3.1	4,000
570-291-741 (Ph. Brz.)	20-16	Max. Ø3.1	4,000
570-290-741 (Brass)	20-16	Max. Ø3.1	4,000
570-291-721 (Ph. Brz.)	22-20	Max. Ø2.7	4,000
570-290-721 (Brass)	22-20	Max. Ø2.7	4,000

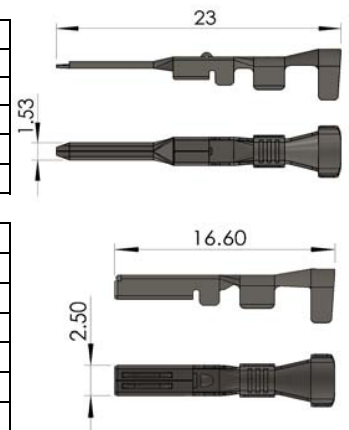

**Crimp Contacts are also available in strips of 40pcs.
Contact EDAC for more information.

Wire Seal:

Part No.	Wire O.D.	Color	AWG#	Ø Dia.	Height
570-260-001	Ø1.7~Ø2.1	Black	22	Ø 5.0	6.0
570-260-002	Ø2.1~Ø2.7	Light Blue	22-20	Ø 5.0	6.0
570-260-003	Ø2.1~Ø2.7	Blue	22-20	Ø 5.0	6.7
570-260-004	Ø2.7~Ø3.1	Brown	20-14	Ø 4.9	5.0



Ordering Guide:

567-002-000-100

SERIES: _____
567, WIRE TO WIRE

NO. OF CONTACTS: _____
001 - 1 CONTACT
002 - 2 CONTACTS
003 - 3 CONTACTS
004 - 4 CONTACTS
006 - 6 CONTACTS
009 - 9 CONTACTS

CONTACT CODE: _____
000 - NO CONTACTS (ONLY FOR CRIMP CONTACTS)

STYLE: _____
310 - WHITE MALE HOUSING FOR CRIMP CONTACTS
410 - WHITE FEMALE HOUSING FOR CRIMP CONTACTS

Assembly Layout

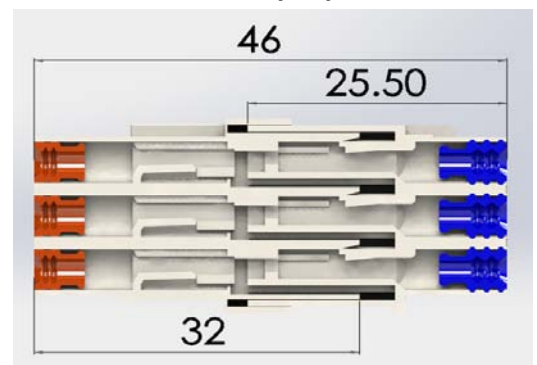

Male Housing:

567-001-000-310

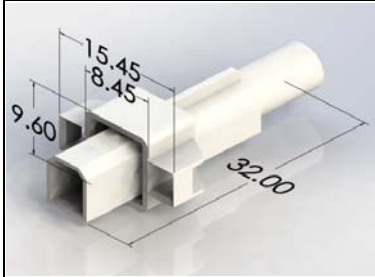

567-002-000-310

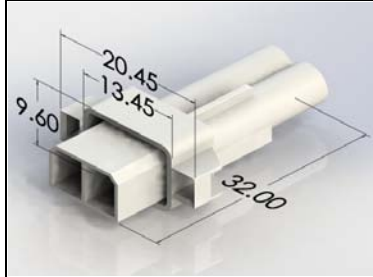

567-003-000-310

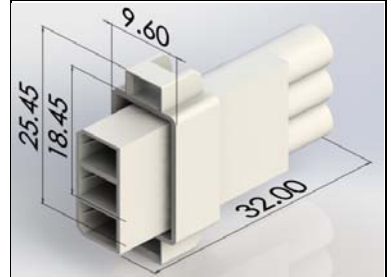

567-004-000-310

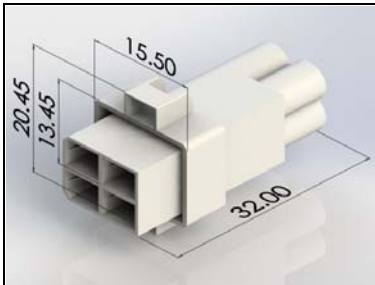

567-006-000-310

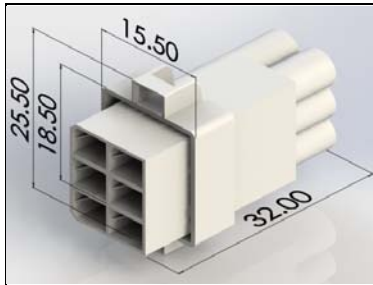

567-009-000-310

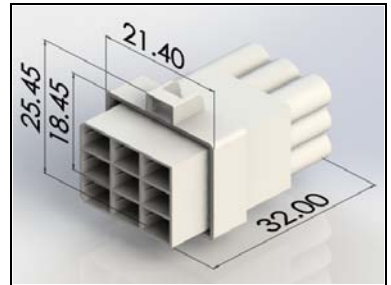

Female Housing:

567-001-000-410

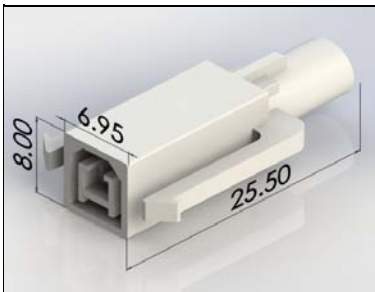

567-002-000-410

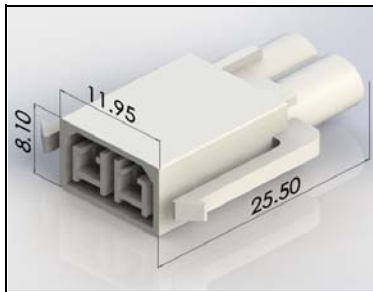

567-003-000-410

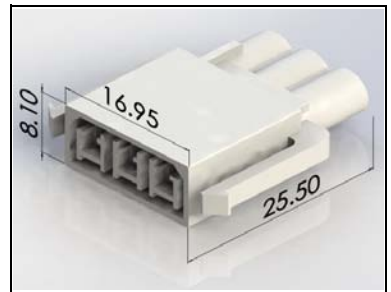

567-004-000-410

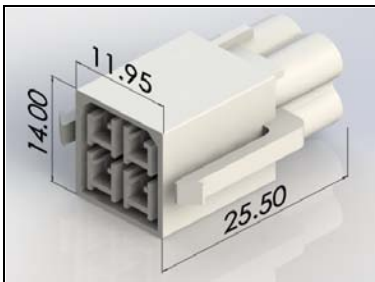

567-006-000-410

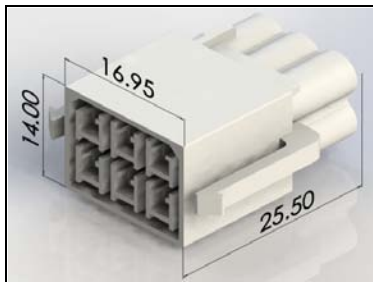

567-009-000-410

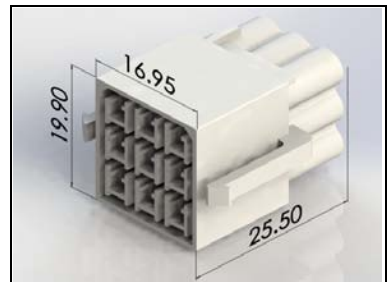

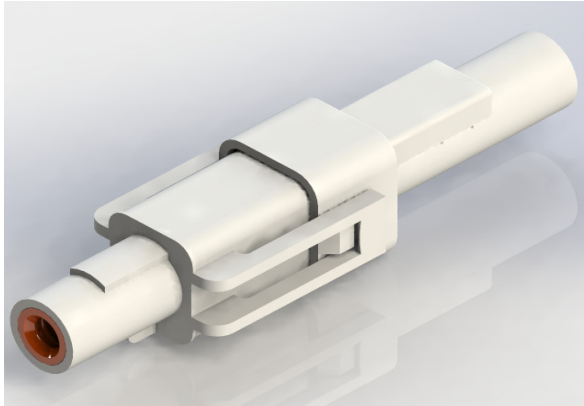

- Rated Current: 12A max
- Splashproof Solution for Single Position
- Available in Wire-to-Wire Option
- True Crimp and Poke Solution with various sized wire seals available
- Available with wire already installed
- Splash Proof Grade IP52 (JIS C0920) Certified



Specifications:

Rated Voltage	300V
Rated Current	12A max
Withstanding Voltage	1700V AC (rms)
Contact Resistance	10 mΩ max
Insulation Resistance	1000 MΩ min./DC500V
Temperature Range	-40°C to +105°C

Materials:

Housing	PBT, UL 94V-0
Contact	Ph. Brz. or Brass
Contact Plating	Tin Plating
Wire Seal	Silicone Rubber

**Crimp Contacts are also available in strips of 40pcs. Contact EDAC for more information.

Wire Seal:

Part No.	Wire O.D.	Color	AWG#	Ø Dia.	Height
570-260-001	Ø1.7~Ø2.1	Black	22	Ø 5.0	6.0
570-260-002	Ø2.1~Ø2.7	Light Blue	22-20	Ø 5.0	6.0
570-260-003	Ø2.1~Ø2.7	Blue	22-20	Ø 5.0	6.7
570-260-004	Ø2.7~Ø3.1	Brown	20-14	Ø 4.9	5.0

Crimp Contact:

Male Contact (Pin)			
Part No (Material)	AWG#	Ins. Dia.	Pcs/Reel
570-290-751 (Brass)	14	Max. Ø3.1	4,000
570-291-731 (Ph. Brz.)	20-16	Max. Ø3.1	4,000
570-290-731 (Brass)	20-16	Max. Ø3.1	4,000
570-290-711 (Brass)	22-20	Max. Ø2.7	4,000

Female Contact (Socket)			
Part No (Material)	AWG#	Ins. Dia.	Pcs/Reel
570-290-761 (Brass)	14	Max. Ø3.1	4,000
570-291-741 (Ph. Brz.)	20-16	Max. Ø3.1	4,000
570-290-741 (Brass)	20-16	Max. Ø3.1	4,000
570-291-721 (Ph. Brz.)	22-20	Max. Ø2.7	4,000
570-290-721 (Brass)	22-20	Max. Ø2.7	4,000

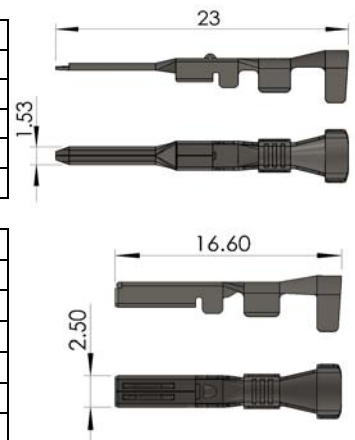

568-001-000-100

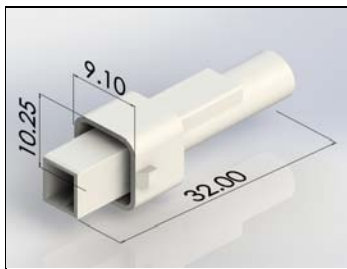

Male Housing:

568-001-000-200

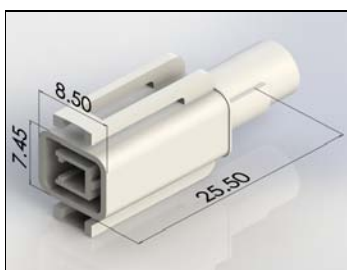

Female Housing:

Ordering Guide:

Assembly Layout

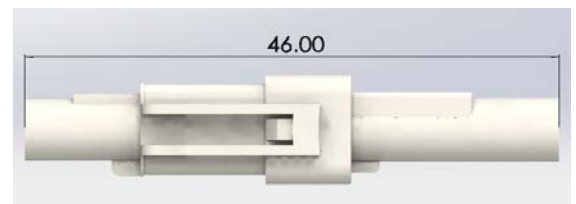

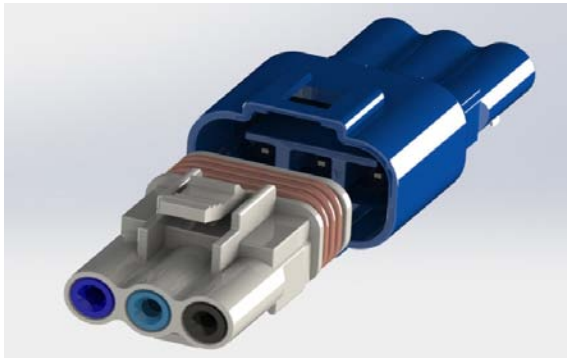

- 5.8mm Pitch, Rated Current: 10A max
- Fully Waterproof with Double Latch Solution
- Available in Wire-to-Wire and Wire-to-Board Options
- Seals preassembled into housing; no external sealing required available in 1, 2, or 3 Positions
- True Crimp and Poke Solution
- Internal Polarization to Prevent Mismatching
- Available with wire already installed
- Wide range of wire sizes available
- Waterproof Grade IP67 Certified



Specifications:

No. of Positions	1, 2, 3P
Pitch	5.8mm
Rated Voltage	300V
Rated Current	10A max
Withstanding Voltage	1700V AC (rms)
Contact Resistance	10 mΩ max
Insulation Resistance	1000 MΩ min./DC500V
Temperature Range	-40°C to +105°C
PCB Thickness	1.6mm

Materials:

Crimp & Poke	Housing	PBT, UL 94V-0
	Contact	Ph. Brz. or Brass
PCB Header	Housing	PBT with Glass, UL 94V-0
	Contact	Brass
Contact Plating	Tin Plating	
Wire & Housing Seals	Silicone Rubber	

Crimp Contact:

Male Contact (Pin)			
Part No (Material)	AWG#	Ins. Dia.	Pcs/Reel
570-290-751 (Brass)	14	Max. Ø3.1	4,000
570-291-731 (Ph. Brz.)	20-16	Max. Ø3.1	4,000
570-290-731 (Brass)	20-16	Max. Ø3.1	4,000
570-290-711 (Brass)	22-20	Max. Ø2.7	4,000

Female Contact (Socket)			
Part No (Material)	AWG#	Ins. Dia.	Pcs/Reel
570-290-761 (Brass)	14	Max. Ø3.1	4,000
570-291-741 (Ph. Brz.)	20-16	Max. Ø3.1	4,000
570-290-741 (Brass)	20-16	Max. Ø3.1	4,000
570-291-721 (Ph. Brz.)	22-20	Max. Ø2.7	4,000
570-290-721 (Brass)	22-20	Max. Ø2.7	4,000

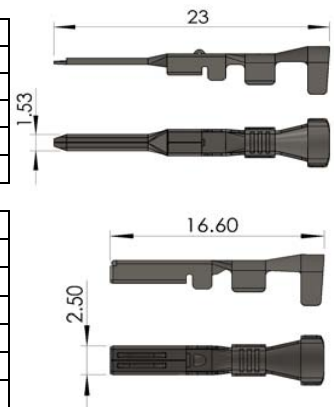

**Crimp Contacts are also available in strips of 40pcs.
Contact EDAC for more information.
**Housing seals are already pre-assembled in the connector.

Wire Seal:

Part No.	Wire O.D.	Color	AWG#	Ø Dia.	Height
570-260-001	Ø1.7~Ø2.1	Black	22	Ø 5.0	6.0
570-260-002	Ø2.1~Ø2.7	Light Blue	22-20	Ø 5.0	6.0
570-260-003	Ø2.1~Ø2.7	Blue	22-20	Ø 5.0	6.7
570-260-004	Ø2.7~Ø3.1	Brown	20-14	Ø 4.9	5.0



Ordering Guide:

572-002-000-100

SERIES: _____
572, WIRE TO WIRE
WIRE TO BOARD

NO. OF CONTACTS: _____
001 - 1 CONTACT
002 - 2 CONTACTS
003 - 3 CONTACTS

CONTACT CODE: _____
000 - NO CONTACTS (ONLY FOR CRIMP CONTACTS)
420 - BOARD MOUNT CONTACTS

STYLE: _____
101 - WHITE MALE HOUSING (ONLY FOR BOARD MOUNT CONTACTS)
301 - BLUE MALE HOUSING (ONLY FOR BOARD MOUNT CONTACTS)
100 - WHITE MALE HOUSING FOR CRIMP CONTACTS
300 - BLUE MALE HOUSING FOR CRIMP CONTACTS
200 - WHITE FEMALE HOUSING FOR CRIMP CONTACTS
400 - BLUE FEMALE HOUSING FOR CRIMP CONTACTS

Assembly Layout

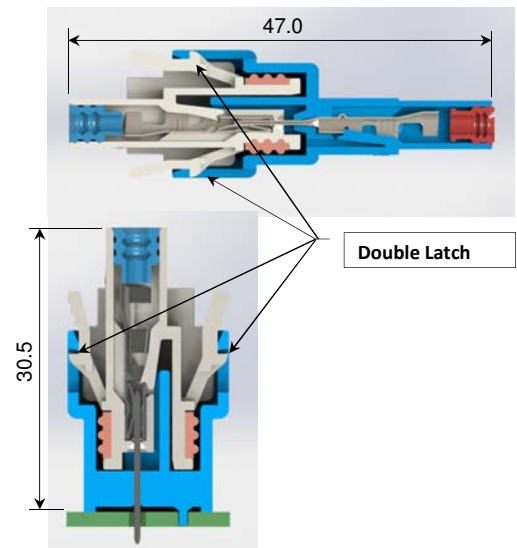

Wire to Wire / Wire to Board 5.8mm Pitch

Male Housing:

572-001-000-XXX

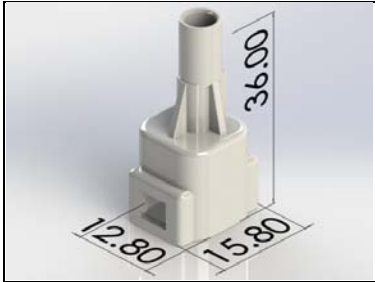

572-002-000-XXX

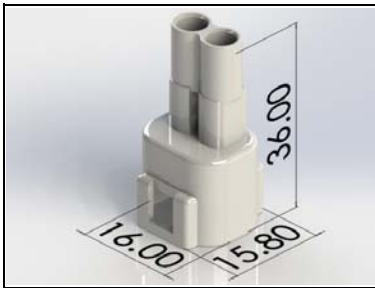

572-003-000-XXX

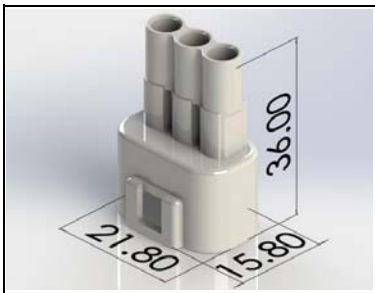

Female Housing:

572-001-000-YYY

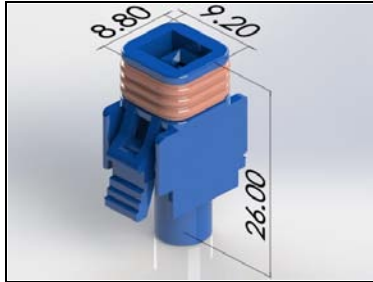

572-002-000-YYY

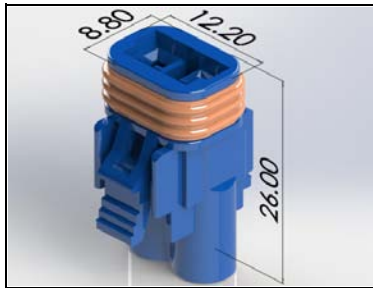

572-003-000-YYY



PCB Header

572-001-420-XXX

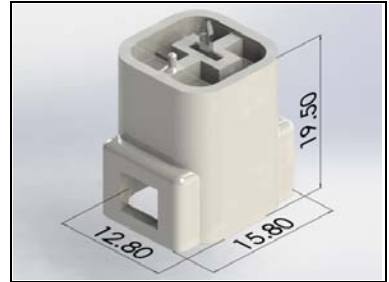

572-002-420-XXX

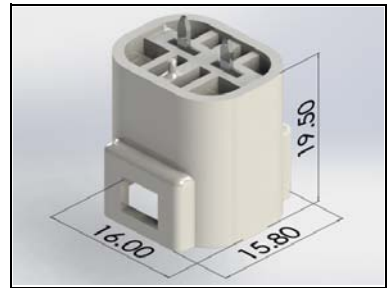

572-003-420-XXX

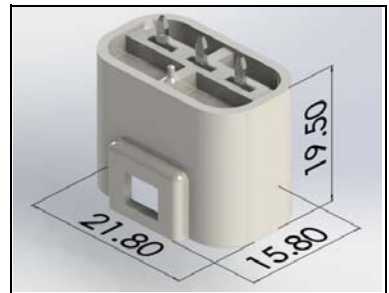

Male Housing:

Housing Color	XXX
White	100
Blue	300

Female Housing:

Housing Color	YYY
White	200
Blue	400

PCB Header

Housing Color	XXX
White	101
Blue	301



Fig.1: Showing female contact back side



Fig.2: Showing male contact back side

STEP 1:

- Prepare the cable wire of stripped length of 2.0mm
- Crimp the contact to the cable wire as shown in Fig.1 for the female contact and in Fig.2 for the male contact

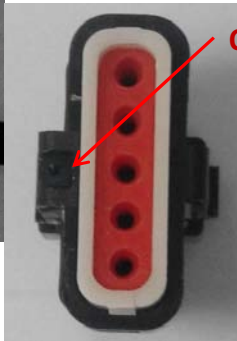

Fig.3: Female Housing
Pre-assembled with wire seal

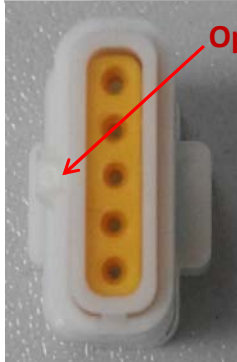
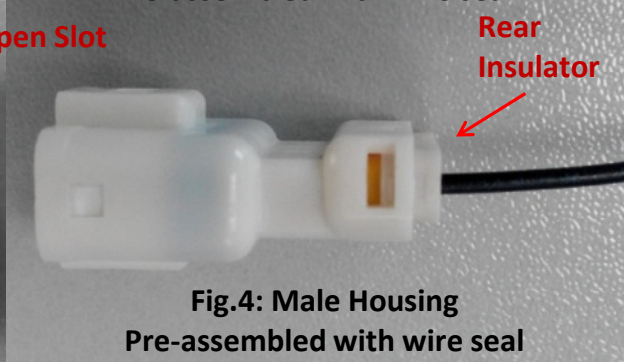

Fig.4: Male Housing
Pre-assembled with wire seal



STEP 2:

- Ensure that the back side of the contact is aligned to the open slot of the pre-assembled housing before inserting
- Insert the contact + wire assembly into the housing until a "click" sound is heard.
- Illustrations are shown on:

Fig.3: Female Housing

Fig.4: Male Housing

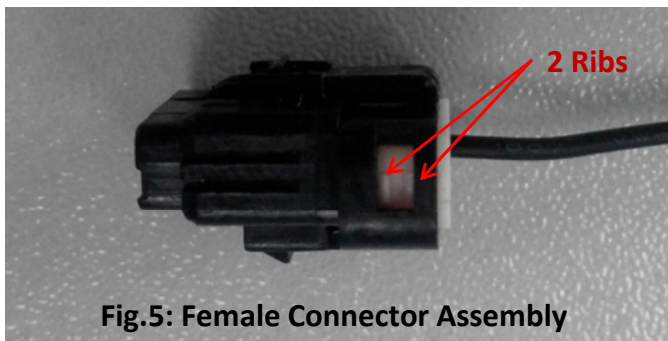

Fig.5: Female Connector Assembly

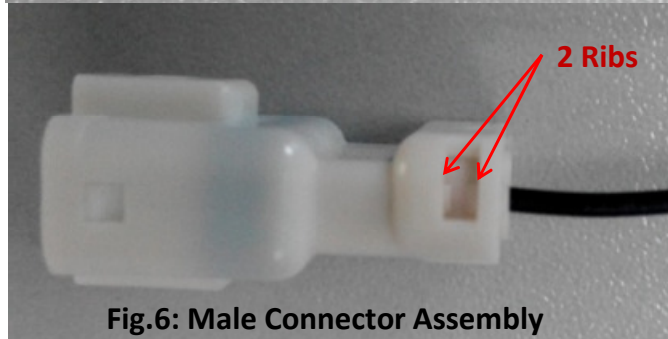

Fig.6: Male Connector Assembly

STEP 3:

- After the wires are inserted, press the rear insulator to finish the connector assembly
- NOTE: The 2 ribs of the rear insulator should be within the window opening of the housing

- Illustrations are shown on:

Fig.5: Female Connector Assembly

Fig.6: Male Connector Assembly

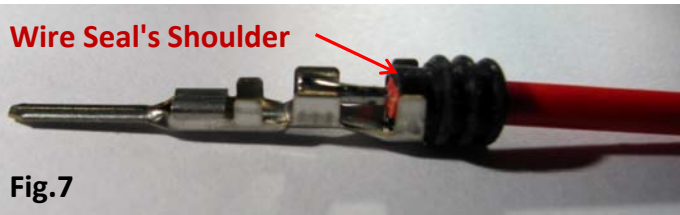

STEP 1:

- Prepare the cable wire of stripped length of 5.0mm
- Ensure that the wire seal's shoulder is properly placed on the contact, as shown in Fig.7
- This is applicable to both Female and Male contacts



STEP 2:

- Crimp the contacts to cable + wire seal as shown on:
Fig.8: Male Contact Assembly
Fig.9: Female Contact Assembly



STEP 3:

- In a position as shown in:
Fig.10: Male contact assembly's crimp side is aligned opposite the wider side of the male housing
Fig.11: Female contact assembly's crimp side is aligned opposite the lower latch of the female housing
- Insert the contact + wire assembly into the housing until a "click" sound is heard

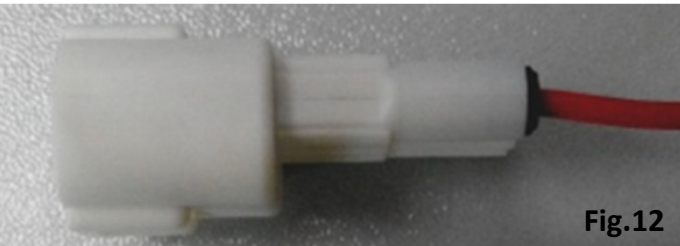
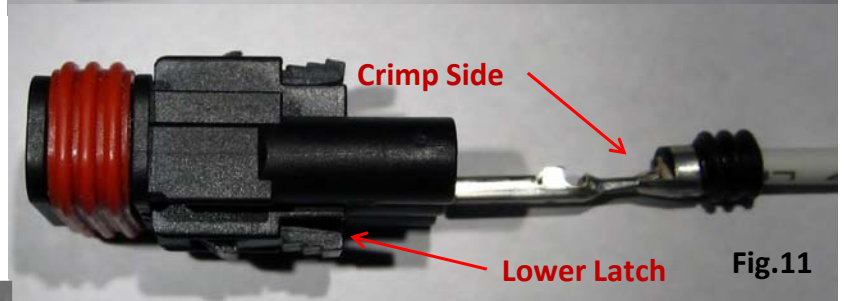
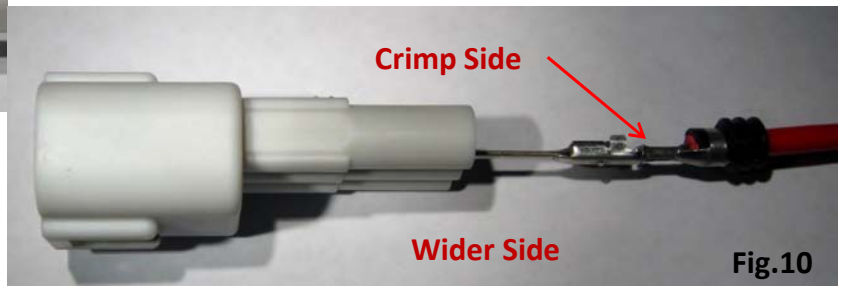

STEP 4:

- Press in the wire seal to finish the assembly, as shown in:
Fig.12: Male Connector Assembly
Fig.13: Female Connector Assembly





AUTOMATIC CONTACT CRIMP MACHINE TOOL

- Part Number 516-280-700 for base machine
- Applicators available to crimp all 560, 566, 567, 568 and 572 series contacts
- All required guards for operator safety
- Easy access for all setting changes
- Foot switch to initiate crimp cycle
- Mounts to any bench surface
- Quick change applicators allow for fast conversions from one contact type to another
- Requires 110V 50/60Hz electrical supply

CONTACT HAND CRIMP TOOL

- Part Number: 565-280-210
- Hand crimp tool for 560, 567, 568 and 572 series contacts
- Manual hand crimp tool
- Uses contacts on carrier strip, crimps them and cuts the contacts from the carrier
- For 566 series, use crimper 566-280-200



CONTACT EJECTION TOOL

- Part Number: 570-280-300
- Ejection tool for 567, 568 and 572 series contacts



- Part Number: 565-280-301
- Ejection tool for 560 series contacts



Mouser Electronics

Authorized Distributor

Click to View Pricing, Inventory, Delivery & Lifecycle Information:

EDAC:

[565-200-100](#) [566-003-000-220](#) [566-005-000-210](#) [566-002-000-210](#) [566-002-724-220](#) [566-005-420-101](#) [566-003-000-120](#) [566-002-714-120](#) [566-002-000-310](#) [566-002-000-220](#) [566-002-725-220](#) [566-002-000-120](#) [565-290-711P60](#)
[565-290-741P60](#) [565-290-731P60](#) [565-290-721P60](#)