

SFH618A-2X, SFH618A-3X, SFH618A-4X,
SFH618-2, SFH618-3, SFH618-4



ISOCOM

COMPONENTS

LOW INPUT CURRENT PHOTOTRANSISTOR OPTICALLY COUPLED ISOLATORS



APPROVALS

- UL recognised, File No. E91231
Package Code " EE "

'X' SPECIFICATION APPROVALS

- VDE 0884 in 3 available lead form :-
- STD
- G form
- SMD approved to CECC 00802
- Certified to EN60950 by :-
Nemko - Certificate No. P01102465

DESCRIPTION

The SFH618 series of optically coupled isolators consist of infrared light emitting diodes and NPN silicon photo transistors in space efficient dual in line plastic packages.

FEATURES

- Options :-
10mm lead spread - add G after part no.
Surface mount - add SM after part no.
Tape&reel - add SMT&R after part no.
- Low input current 0.5mA I_F
- High Current Transfer Ratios (63-320% at 1mA, 32% min at 0.5mA)
- High Isolation Voltage (5.3kV_{RMS}, 7.5kV_{PK})
- High BV_{CEO} (55V min)
- All electrical parameters 100% tested
- Custom electrical selections available

APPLICATIONS

- Computer terminals
- Industrial systems controllers
- Measuring instruments
- Signal transmission between systems of different potentials and impedances

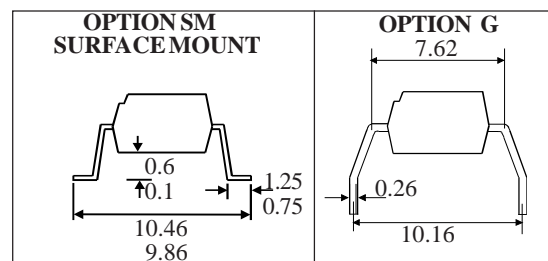
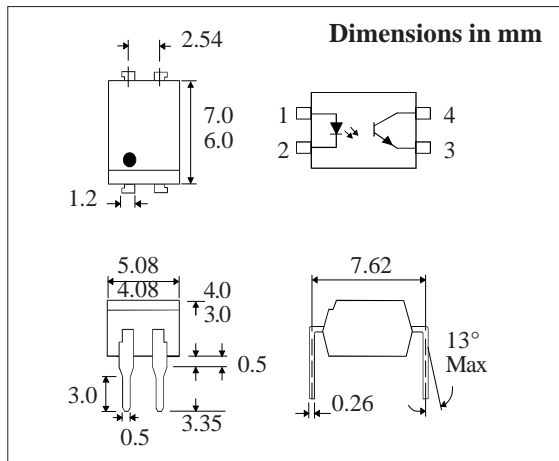

ISOCOM COMPONENTS LTD
Unit 25B, Park View Road West,
Park View Industrial Estate, Brenda Road
Hartlepool, Cleveland, TS25 1YD
Tel: (01429) 863609 Fax :(01429) 863581

ABSOLUTE MAXIMUM RATINGS

(25°C unless otherwise specified)

Storage Temperature _____	-55°C to +125°C
Operating Temperature _____	-30°C to +100°C
Lead Soldering Temperature (1/16 inch (1.6mm) from case for 10 secs)	260°C

INPUT DIODE

Forward Current _____	50mA
Reverse Voltage _____	6V
Power Dissipation _____	70mW

OUTPUT TRANSISTOR

Collector-emitter Voltage BV_{CEO} _____	55V
Emitter-collector Voltage BV_{ECO} _____	6V
Collector Current _____	50mA
Power Dissipation _____	150mW

POWER DISSIPATION

Total Power Dissipation _____	200mW
(derate linearly 2.67mW/°C above 25°C)	

ELECTRICAL CHARACTERISTICS ($T_A = 25^\circ\text{C}$ Unless otherwise noted)

PARAMETER		MIN	TYP	MAX	UNITS	TEST CONDITION
Input	Forward Voltage (V_F)			1.5	V	$I_F = 5\text{mA}$
	Reverse Current (I_R)			10	μA	$V_R = 6\text{V}$
Output	Collector-emitter Breakdown (BV_{CEO}) (Note 2)	55			V	$I_C = 1\text{mA}$
	Emitter-collector Breakdown (BV_{ECO})	6			V	$I_E = 100\mu\text{A}$
	Collector-emitter Dark Current (I_{CEO})			200	nA	$V_{CE} = 10\text{V}$
Coupled	Current Transfer Ratio (CTR) (Note 2)				%	
	SFH618-2	63		125	%	$1\text{mA } I_F, 0.5\text{V } V_{CE}$
	SFH618-2	32			%	$0.5\text{mA } I_F, 1.5\text{V } V_{CE}$
	SFH618-3	100		200	%	$1\text{mA } I_F, 0.5\text{V } V_{CE}$
	SFH618-3	50			%	$0.5\text{mA } I_F, 1.5\text{V } V_{CE}$
	SFH618-4	160		320	%	$1\text{mA } I_F, 0.5\text{V } V_{CE}$
	SFH618-4	80			%	$0.5\text{mA } I_F, 1.5\text{V } V_{CE}$
	Collector-emitter Saturation Voltage V_{CESAT}					
	SFH618-2			0.4	V	$1\text{mA } I_F, 0.32\text{mA } I_C$
	SFH618-3			0.4	V	$1\text{mA } I_F, 0.5\text{mA } I_C$
SFH618-4			0.4	V	$1\text{mA } I_F, 0.8\text{mA } I_C$	
Input to Output Isolation Voltage V_{ISO}	5300				V_{RMS}	See note 1
	7500				V_{PK}	See note 1
Input-output Isolation Resistance R_{ISO}	5×10^{10}				Ω	$V_{IO} = 500\text{V}$ (note 1)
Output Rise Time, tr		4	18		μs	$V_{CE} = 2\text{V}, I_C = 2\text{mA}$
Output Fall Time, tf		3	18		μs	$R_L = 100\Omega$

Note 1 Measured with input leads shorted together and output leads shorted together.

Note 2 Special Selections are available on request. Please consult the factory.

Collector Power Dissipation vs. Ambient Temperature

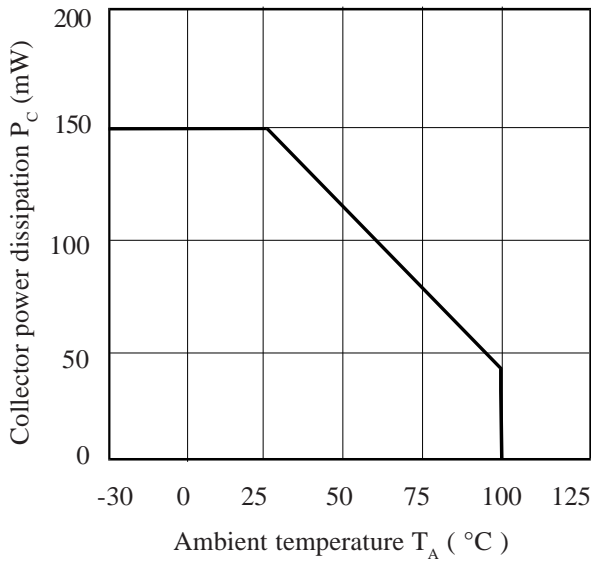

Collector Current vs. Low Collector-emitter Voltage (normalized to SFH618-2 & SFH618-3)

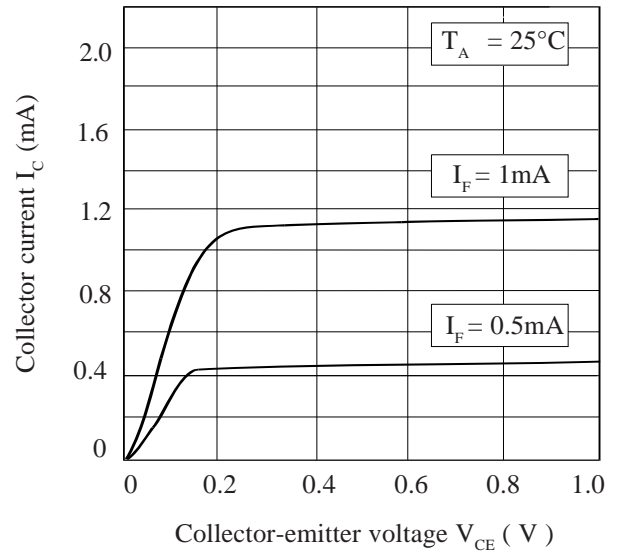

Forward Current vs. Ambient Temperature

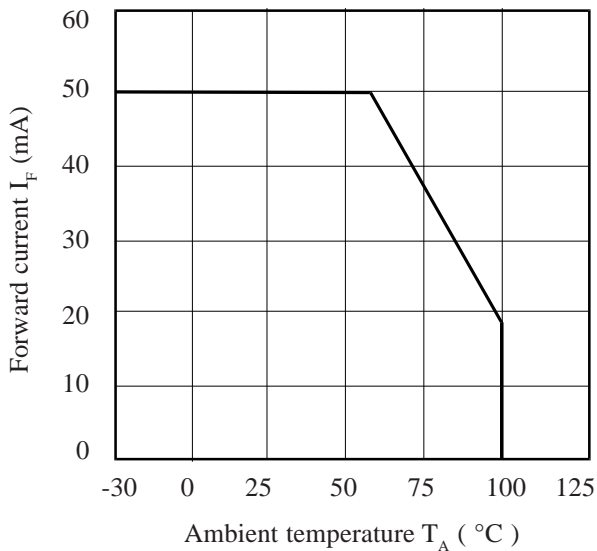

Relative Current Transfer Ratio vs. Ambient Temperature

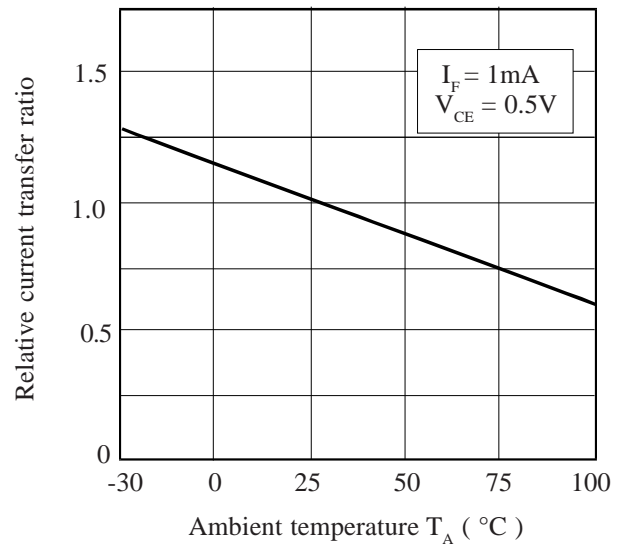

Collector-emitter Saturation Voltage vs. Ambient Temperature

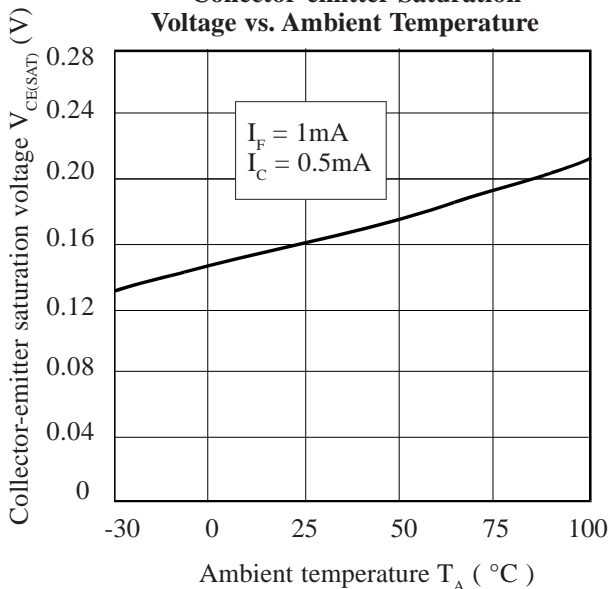

Current Transfer Ratio vs. Forward Current (normalized to SFH618-2 & SFH618-3)

