

IRLR3636PbF IRLU3636PbF

Applications

- DC Motor Drive
- High Efficiency Synchronous Rectification in SMPS
- Uninterruptible Power Supply
- High Speed Power Switching
- Hard Switched and High Frequency Circuits

HEXFET® Power MOSFET

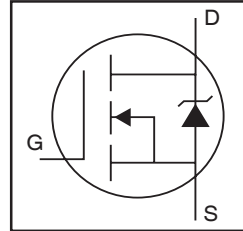

V_{DSS}	60V
$R_{DS(on)}$ typ.	5.4mΩ
	max.
I_D (Silicon Limited)	99A ①
I_D (Package Limited)	50A

Benefits

- Optimized for Logic Level Drive
- Very Low $R_{DS(ON)}$ at 4.5V V_{GS}
- Superior R^*Q at 4.5V V_{GS}
- Improved Gate, Avalanche and Dynamic dV/dt Ruggedness
- Fully Characterized Capacitance and Avalanche SOA
- Enhanced body diode dV/dt and dI/dt Capability
- Lead-Free

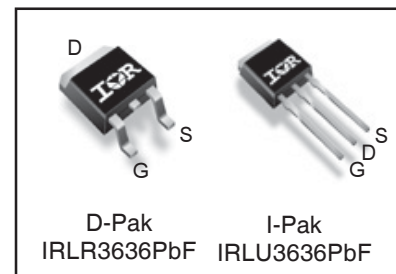

G	D	S
Gate	Drain	Source

Absolute Maximum Ratings

Symbol	Parameter	Max.	Units
I_D @ $T_C = 25^\circ\text{C}$	Continuous Drain Current, V_{GS} @ 10V (Silicon Limited)	99 ①	A
I_D @ $T_C = 100^\circ\text{C}$	Continuous Drain Current, V_{GS} @ 10V (Silicon Limited)	70 ①	
I_D @ $T_C = 25^\circ\text{C}$	Continuous Drain Current, V_{GS} @ 10V (Package Limited)	50	
I_{DM}	Pulsed Drain Current ②	396	
P_D @ $T_C = 25^\circ\text{C}$	Maximum Power Dissipation	143	W
	Linear Derating Factor	0.95	W/°C
V_{GS}	Gate-to-Source Voltage	±16	V
dv/dt	Peak Diode Recovery ④	22	V/ns
T_J T_{STG}	Operating Junction and Storage Temperature Range	-55 to + 175	°C
	Soldering Temperature, for 10 seconds	300 (1.6mm from case)	

Avalanche Characteristics

E_{AS} (Thermally limited)	Single Pulse Avalanche Energy ③	170	mJ
I_{AR}	Avalanche Current ②	See Fig.14, 15, 22a, 22b	A
E_{AR}	Repetitive Avalanche Energy ②		mJ

Thermal Resistance

Symbol	Parameter	Typ.	Max.	Units
$R_{\theta JC}$	Junction-to-Case ⑨	—	1.05	°C/W
$R_{\theta JA}$	Junction-to-Ambient (PCB Mount) ⑧	—	50	
$R_{\theta JA}$	Junction-to-Ambient	—	110	

Static @ $T_J = 25^\circ\text{C}$ (unless otherwise specified)

Symbol	Parameter	Min.	Typ.	Max.	Units	Conditions
$V_{(BR)DSS}$	Drain-to-Source Breakdown Voltage	60	—	—	V	$V_{GS} = 0V, I_D = 250\mu A$
$\Delta V_{(BR)DSS}/\Delta T_J$	Breakdown Voltage Temp. Coefficient	—	0.07	—	V/°C	Reference to 25°C , $I_D = 5mA$ ②
$R_{DS(on)}$	Static Drain-to-Source On-Resistance	—	5.4	6.8	m Ω	$V_{GS} = 10V, I_D = 50A$ ⑤
		—	6.6	8.3		$V_{GS} = 4.5V, I_D = 50A$ ⑤
$V_{GS(th)}$	Gate Threshold Voltage	1.0	—	2.5	V	$V_{DS} = V_{GS}, I_D = 100\mu A$
I_{DSS}	Drain-to-Source Leakage Current	—	—	20	μA	$V_{DS} = 60V, V_{GS} = 0V$
		—	—	250		$V_{DS} = 60V, V_{GS} = 0V, T_J = 125^\circ\text{C}$
I_{GSS}	Gate-to-Source Forward Leakage	—	—	100	nA	$V_{GS} = 16V$
	Gate-to-Source Reverse Leakage	—	—	-100		$V_{GS} = -16V$
$R_{G(int)}$	Internal Gate Resistance	—	0.6	—	Ω	

Dynamic @ $T_J = 25^\circ\text{C}$ (unless otherwise specified)

Symbol	Parameter	Min.	Typ.	Max.	Units	Conditions
gfs	Forward Transconductance	31	—	—	S	$V_{DS} = 25V, I_D = 50A$
Q_g	Total Gate Charge	—	33	49	nC	$I_D = 50A$
Q_{gs}	Gate-to-Source Charge	—	11	—		$V_{DS} = 30V$
Q_{gd}	Gate-to-Drain ("Miller") Charge	—	15	—		$V_{GS} = 4.5V$ ⑤
Q_{sync}	Total Gate Charge Sync. ($Q_g - Q_{gd}$)	—	18	—		$I_D = 50A, V_{DS} = 0V, V_{GS} = 4.5V$
$t_{d(on)}$	Turn-On Delay Time	—	45	—	ns	$V_{DD} = 39V$
t_r	Rise Time	—	216	—		$I_D = 50A$
$t_{d(off)}$	Turn-Off Delay Time	—	43	—		$R_G = 7.5 \Omega$
t_f	Fall Time	—	69	—		$V_{GS} = 4.5V$ ⑤
C_{iss}	Input Capacitance	—	3779	—	pF	$V_{GS} = 0V$
C_{oss}	Output Capacitance	—	332	—		$V_{DS} = 50V$
C_{rss}	Reverse Transfer Capacitance	—	163	—		$f = 1.0MHz$
$C_{oss \text{ eff. (ER)}}$	Effective Output Capacitance (Energy Related)⑦	—	437	—		$V_{GS} = 0V, V_{DS} = 0V \text{ to } 48V$ ⑦, See Fig.11
$C_{oss \text{ eff. (TR)}}$	Effective Output Capacitance (Time Related)⑥	—	636	—		$V_{GS} = 0V, V_{DS} = 0V \text{ to } 48V$ ⑥

Diode Characteristics

Symbol	Parameter	Min.	Typ.	Max.	Units	Conditions
I_S	Continuous Source Current (Body Diode)	—	—	99	A	MOSFET symbol showing the integral reverse p-n junction diode.
I_{SM}	Pulsed Source Current (Body Diode) ②	—	—	396		
V_{SD}	Diode Forward Voltage	—	—	1.3	V	$T_J = 25^\circ\text{C}, I_S = 50A, V_{GS} = 0V$ ⑤
t_{rr}	Reverse Recovery Time	—	27	—	ns	$T_J = 25^\circ\text{C}$ $V_R = 51V,$
		—	32	—		$T_J = 125^\circ\text{C}$ $I_F = 50A$
Q_{rr}	Reverse Recovery Charge	—	31	—	nC	$T_J = 25^\circ\text{C}$ $di/dt = 100A/\mu s$ ⑤
		—	43	—		$T_J = 125^\circ\text{C}$
I_{RRM}	Reverse Recovery Current	—	2.1	—	A	$T_J = 25^\circ\text{C}$
t_{on}	Forward Turn-On Time	Intrinsic turn-on time is negligible (turn-on is dominated by LS+LD)				

Notes:

- ① Calculated continuous current based on maximum allowable junction temperature. Bond wire current limit is 50A. Note that current limitation arising from heating of the device leads may occur with some lead mounting arrangements.
- ② Repetitive rating; pulse width limited by max. junction temperature.
- ③ Limited by T_{Jmax} , starting $T_J = 25^\circ\text{C}$, $L = 0.136 \text{ mH}$
 $R_G = 25\Omega, I_{AS} = 50A, V_{GS} = 10V$. Part not recommended for use above this value.
- ④ $I_{SD} \leq 50A, di/dt \leq 1109 \text{ A}/\mu s, V_{DD} \leq V_{(BR)DSS}, T_J \leq 175^\circ\text{C}$.

⑤ Pulse width $\leq 400\mu s$; duty cycle $\leq 2\%$.

⑥ $C_{oss \text{ eff. (TR)}}$ is a fixed capacitance that gives the same charging time as C_{oss} while V_{DS} is rising from 0 to 80% V_{DSS} .

⑦ $C_{oss \text{ eff. (ER)}}$ is a fixed capacitance that gives the same energy as C_{oss} while V_{DS} is rising from 0 to 80% V_{DSS} .

⑧ When mounted on 1" square PCB (FR-4 or G-10 Material). For recommended footprint and soldering techniques refer to application note # AN-994 techniques refer to application note #AN-994.

⑨ R_θ is measured at T_J approximately 90°C .

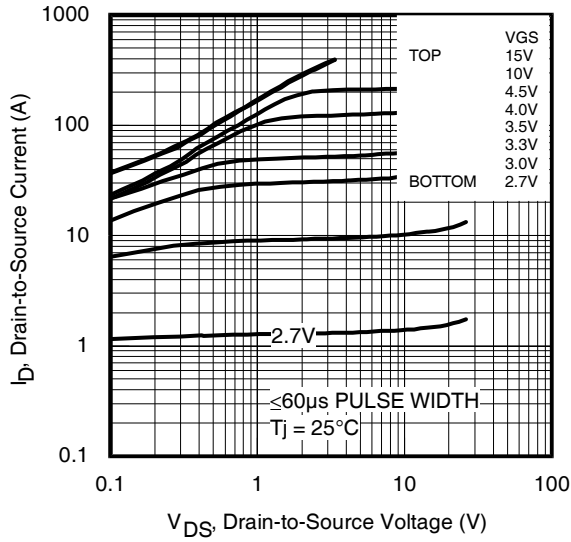

Fig 1. Typical Output Characteristics

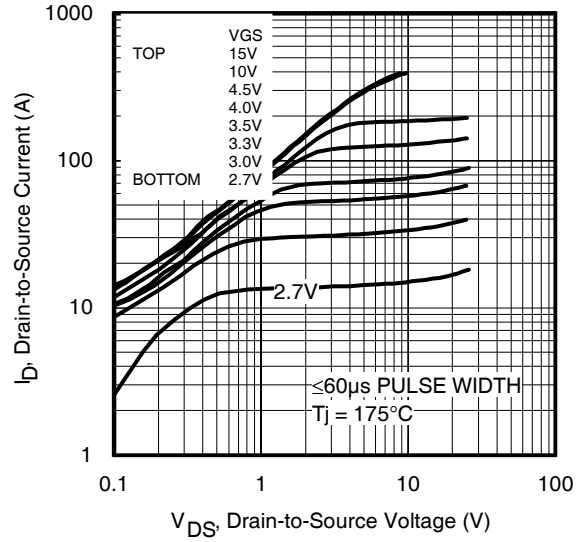

Fig 2. Typical Output Characteristics

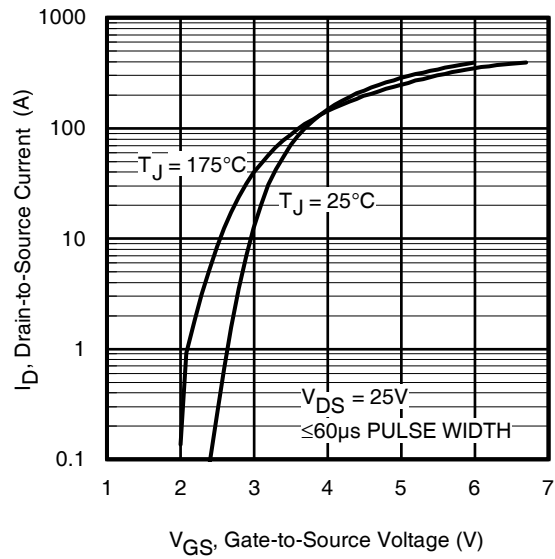

Fig 3. Typical Transfer Characteristics

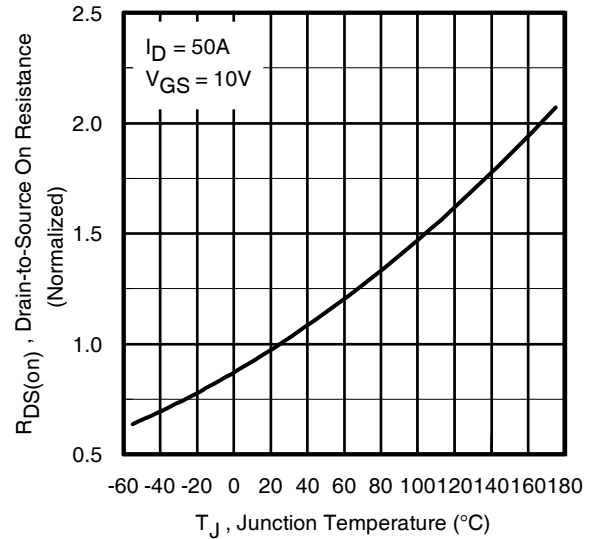

Fig 4. Normalized On-Resistance vs. Temperature

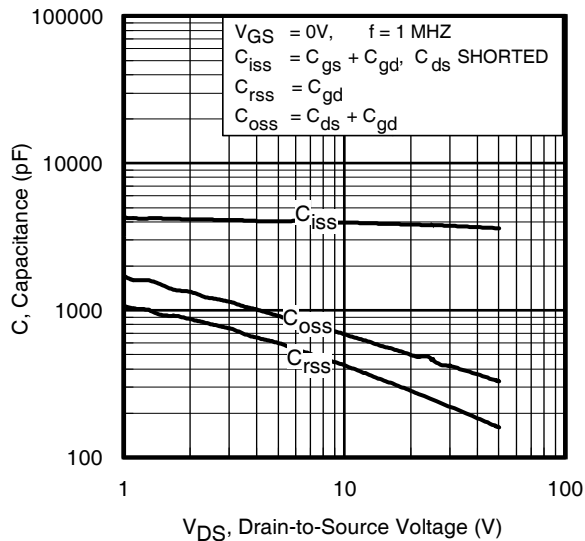

Fig 5. Typical Capacitance vs. Drain-to-Source Voltage

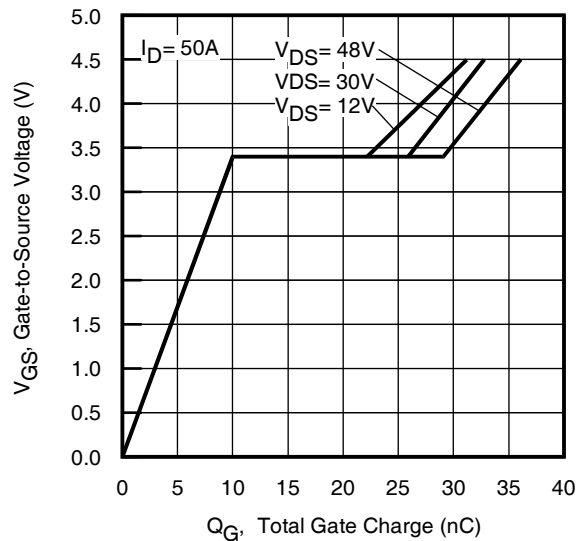

Fig 6. Typical Gate Charge vs. Gate-to-Source Voltage

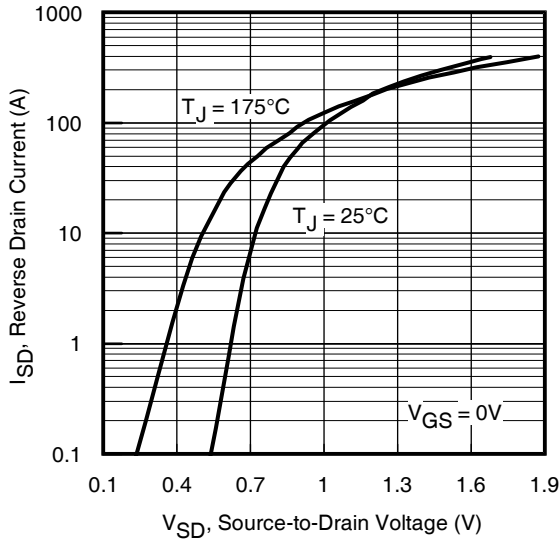

Fig 7. Typical Source-Drain Diode Forward Voltage

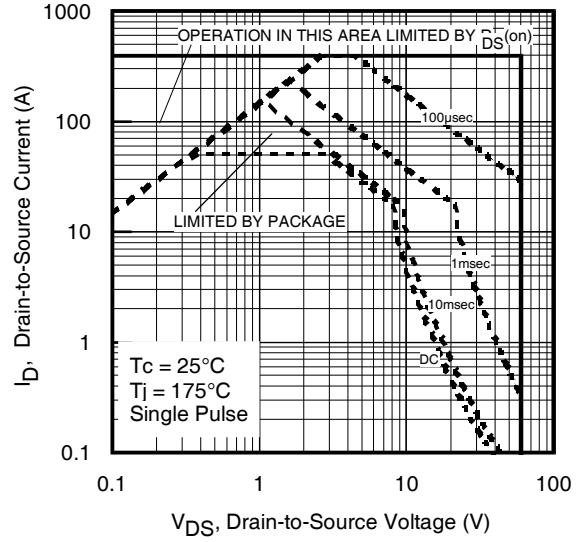

Fig 8. Maximum Safe Operating Area

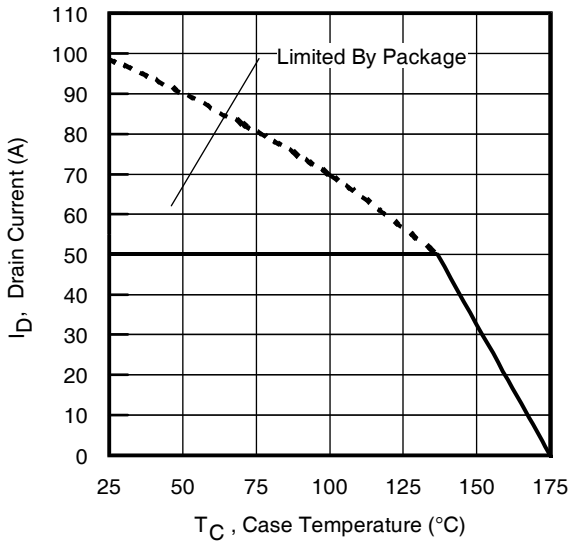

Fig 9. Maximum Drain Current vs. Case Temperature

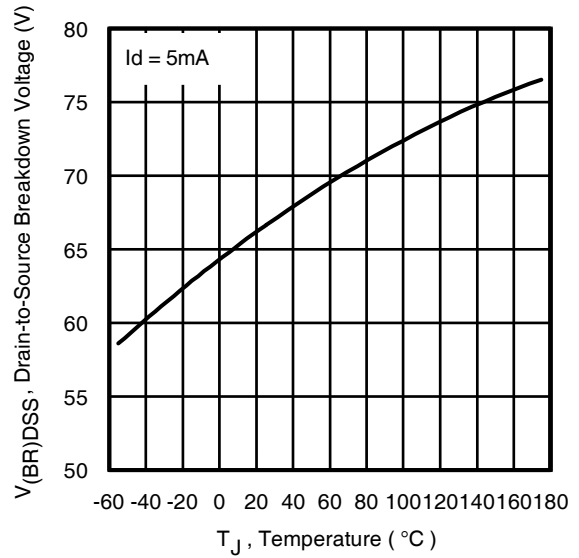

Fig 10. Drain-to-Source Breakdown Voltage

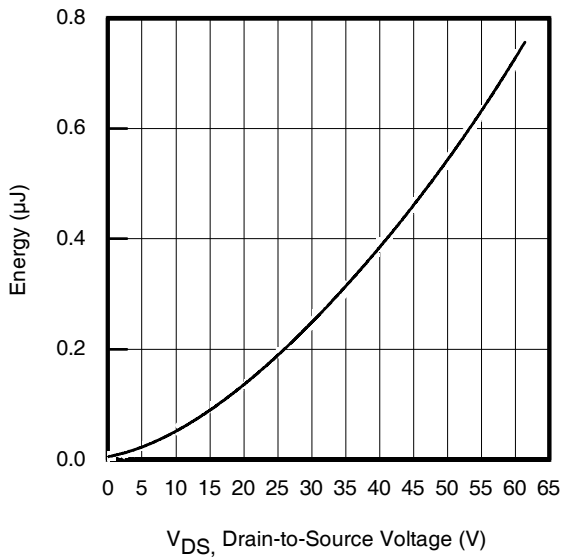

Fig 11. Typical C_{OSS} Stored Energy

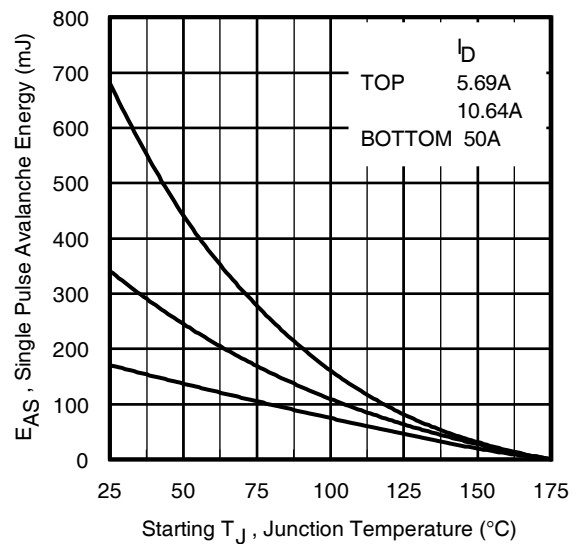

Fig 12. Maximum Avalanche Energy vs. Drain Current

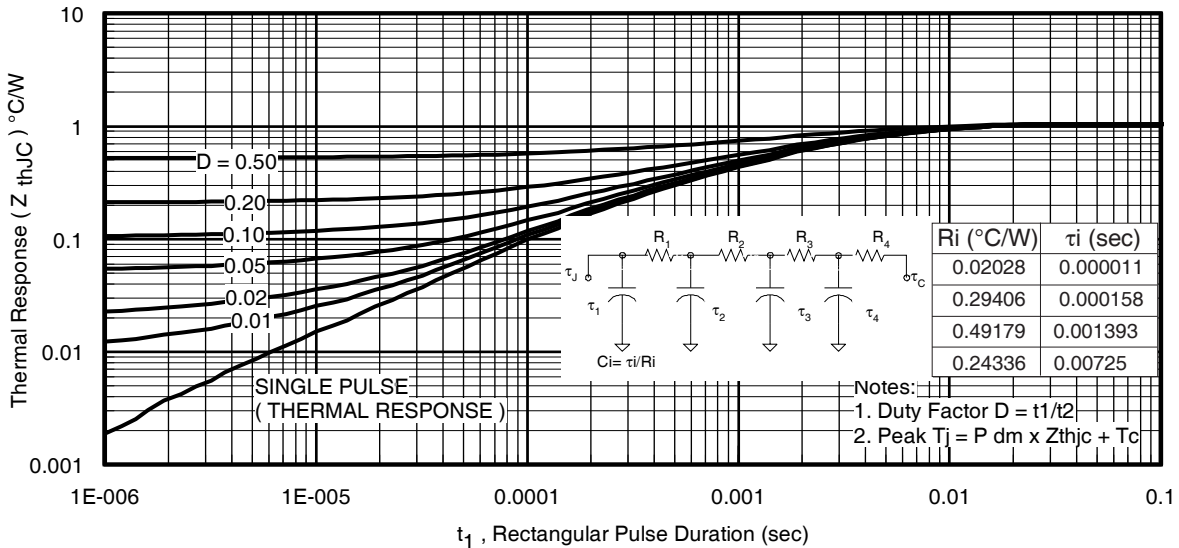

Fig 13. Maximum Effective Transient Thermal Impedance, Junction-to-Case

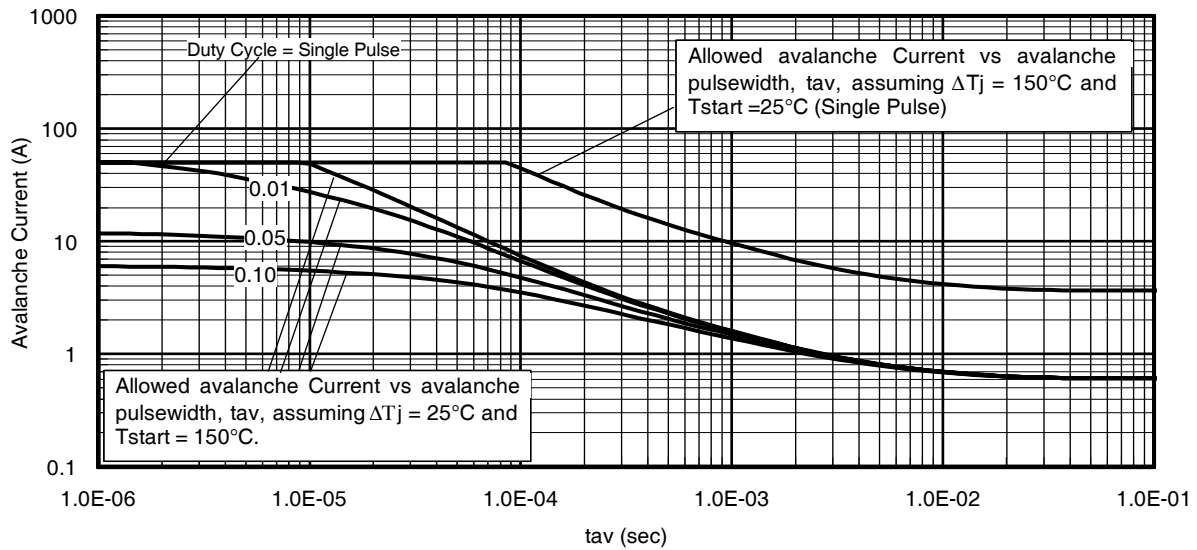
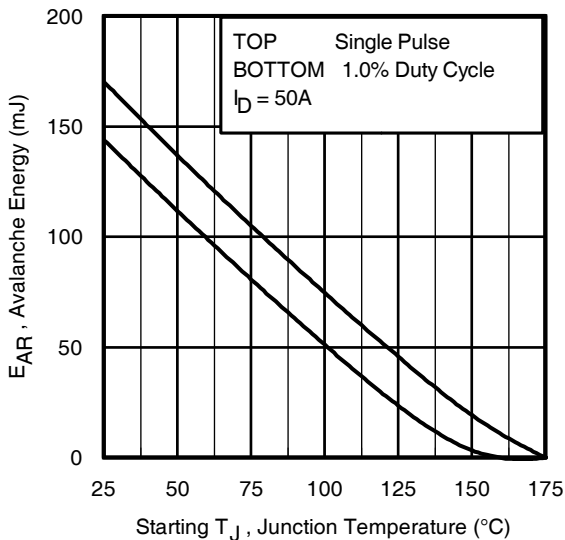

Fig 14. Typical Avalanche Current vs. Pulsewidth



Notes on Repetitive Avalanche Curves , Figures 14, 15:
(For further info, see AN-1005 at www.irf.com)

1. Avalanche failures assumption:
Purely a thermal phenomenon and failure occurs at a temperature far in excess of T_{jmax} . This is validated for every part type.
2. Safe operation in Avalanche is allowed as long as T_{jmax} is not exceeded.
3. Equation below based on circuit and waveforms shown in Figures 16a, 16b.
4. $P_{D(ave)}$ = Average power dissipation per single avalanche pulse.
5. BV = Rated breakdown voltage (1.3 factor accounts for voltage increase during avalanche).
6. I_{av} = Allowable avalanche current.
7. ΔT = Allowable rise in junction temperature, not to exceed T_{jmax} (assumed as 25°C in Figure 14, 15).
 t_{av} = Average time in avalanche.
 D = Duty cycle in avalanche = $t_{av} \cdot f$
 $Z_{thJC}(D, t_{av})$ = Transient thermal resistance, see Figures 13)

$$P_{D(ave)} = 1/2 (1.3 \cdot BV \cdot I_{av}) = \Delta T / Z_{thJC}$$

$$I_{av} = 2 \Delta T / [1.3 \cdot BV \cdot Z_{th}]$$

$$E_{AS(AR)} = P_{D(ave)} \cdot t_{av}$$

Fig 15. Maximum Avalanche Energy vs. Temperature

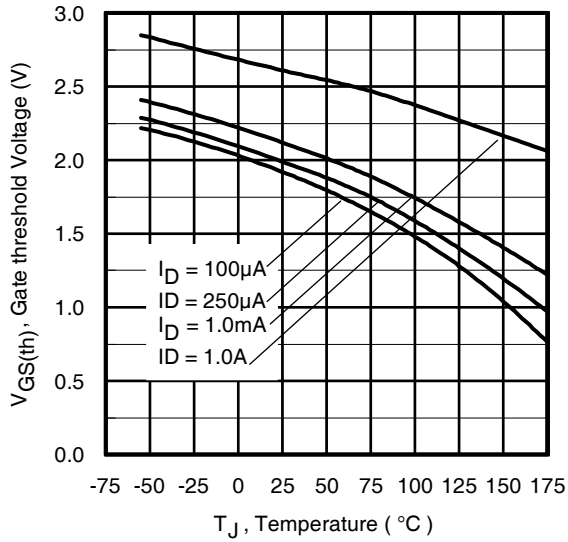

Fig 16. Threshold Voltage vs. Temperature

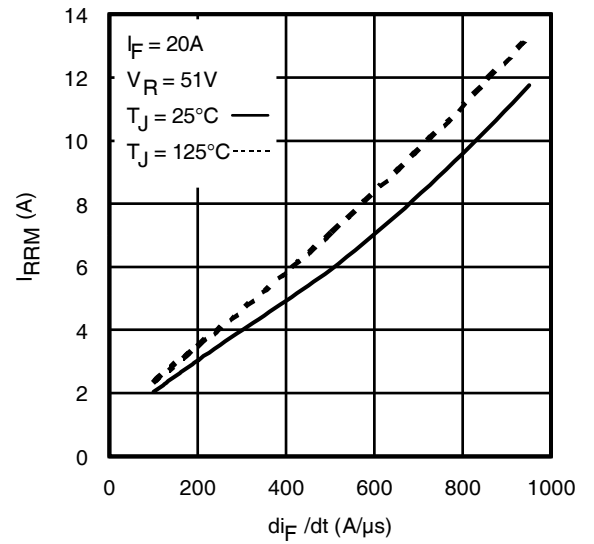

Fig. 17 - Typical Recovery Current vs. di_F/dt

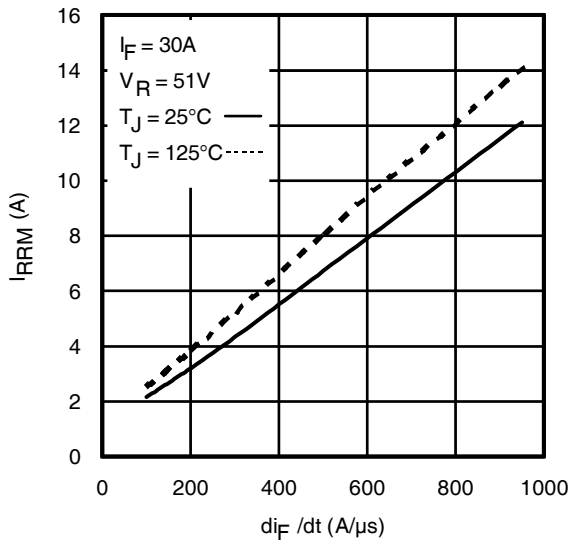

Fig. 18 - Typical Recovery Current vs. di_F/dt

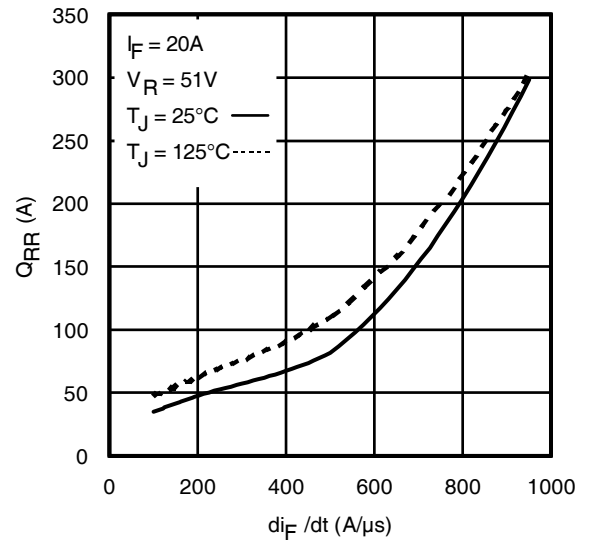

Fig. 19 - Typical Stored Charge vs. di_F/dt

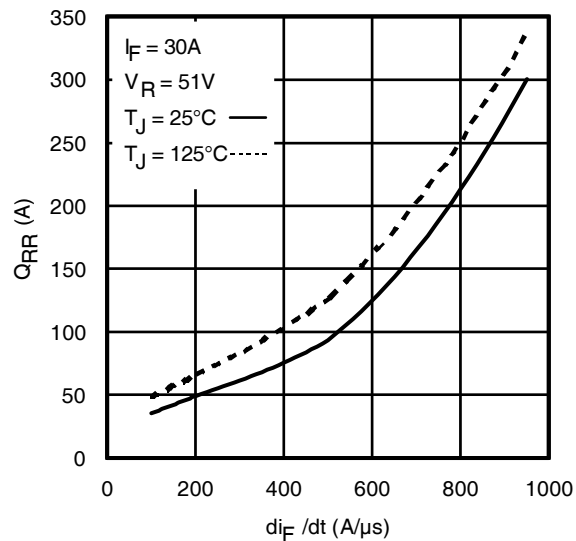

Fig. 20 - Typical Stored Charge vs. di_F/dt



Fig 21. Peak Diode Recovery dv/dt Test Circuit for N-Channel HEXFET® Power MOSFETs



* $V_{GS} = 5V$ for Logic Level Devices



Fig 22a. Unclamped Inductive Test Circuit



Fig 22b. Unclamped Inductive Waveforms



Fig 23a. Switching Time Test Circuit



Fig 23b. Switching Time Waveforms



Fig 24a. Gate Charge Test Circuit



Fig 24b. Gate Charge Waveform

D-Pak (TO-252AA) Package Outline

Dimensions are shown in millimeters (inches)

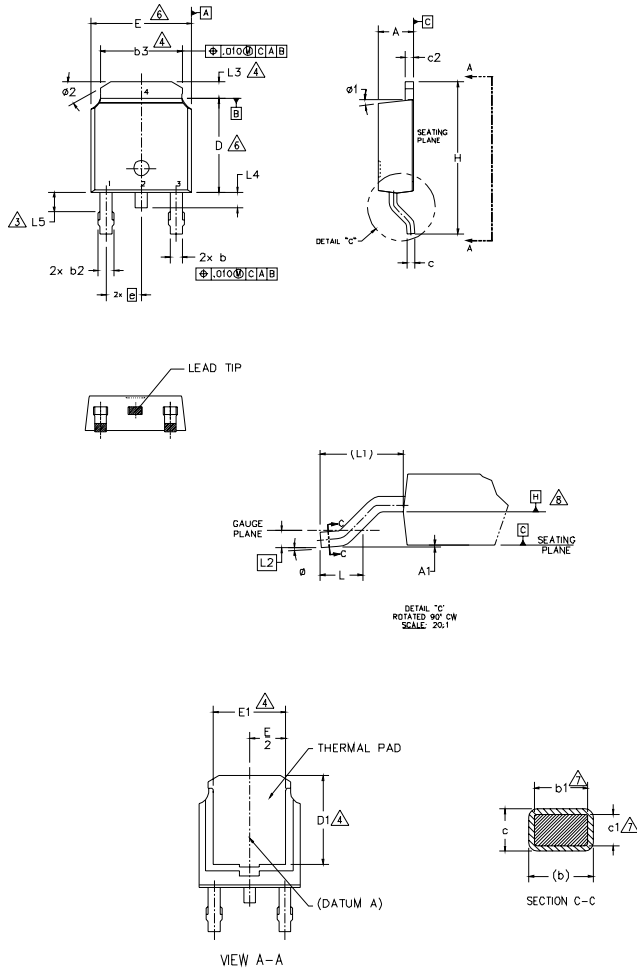

- NOTES:
- 1.- DIMENSIONING AND TOLERANCING PER ASME Y14.5M-1994
 - 2.- DIMENSION ARE SHOWN IN INCHES [MILLIMETERS].
 - 3.- LEAD DIMENSION UNCONTROLLED IN L5.
 - 4.- DIMENSION D1, E1, L3 & b3 ESTABLISH A MINIMUM MOUNTING SURFACE FOR THERMAL PAD.
 - 5.- SECTION C-C DIMENSIONS APPLY TO THE FLAT SECTION OF THE LEAD BETWEEN .005 AND 0.10 [0.13 AND 0.25] FROM THE LEAD TIP.
 - 6.- DIMENSION D & E DO NOT INCLUDE MOLD FLASH. MOLD FLASH SHALL NOT EXCEED .005 [0.13] PER SIDE. THESE DIMENSIONS ARE MEASURED AT THE OUTMOST EXTREMES OF THE PLASTIC BODY.
 - 7.- DIMENSION b1 & c1 APPLIED TO BASE METAL ONLY.
 - 8.- DATUM A & B TO BE DETERMINED AT DATUM PLANE H.
 - 9.- OUTLINE CONFORMS TO JEDEC OUTLINE TO-252AA.

SYMBOL	DIMENSIONS				NOTES
	MILLIMETERS		INCHES		
	MIN.	MAX.	MIN.	MAX.	
A	2.18	2.39	.086	.094	
A1	-	0.13	-	.005	
b	0.64	0.89	.025	.035	
b1	0.65	0.79	.025	.031	7
b2	0.76	1.14	.030	.045	
b3	4.95	5.46	.195	.215	4
c	0.46	0.61	.018	.024	
c1	0.41	0.56	.016	.022	7
c2	0.46	0.89	.018	.035	
D	5.97	6.22	.235	.245	6
D1	5.21	-	.205	-	4
E	6.35	6.73	.250	.265	6
E1	4.32	-	.170	-	4
e	2.29 BSC		.090 BSC		
H	9.40	10.41	.370	.410	
L	1.40	1.78	.055	.070	
L1	2.74 BSC		.108 REF.		
L2	0.51 BSC		.020 BSC		
L3	0.89	1.27	.035	.050	
L4	-	1.02	-	.040	
L5	1.14	1.52	.045	.060	3
ø	0"	10"	0"	10"	
ø1	0"	15"	0"	15"	
ø2	25"	35"	25"	35"	

LEAD ASSIGNMENTS

HEXFET

- 1.- GATE
- 2.- DRAIN
- 3.- SOURCE
- 4.- DRAIN

IGBT & CoPAK

- 1.- GATE
- 2.- COLLECTOR
- 3.- EMITTER
- 4.- COLLECTOR

D-Pak (TO-252AA) Part Marking Information

EXAMPLE: THIS IS AN IRFR120
WITH ASSEMBLY
LOT CODE 1234
ASSEMBLED ON WW 16, 2001
IN THE ASSEMBLY LINE "A"

Note: "P" in assembly line position
indicates "Lead-Free"

"P̄" in assembly line position indicates
"Lead-Free" qualification to the consumer-level

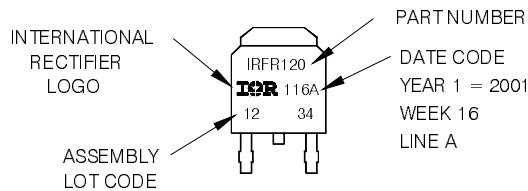

OR

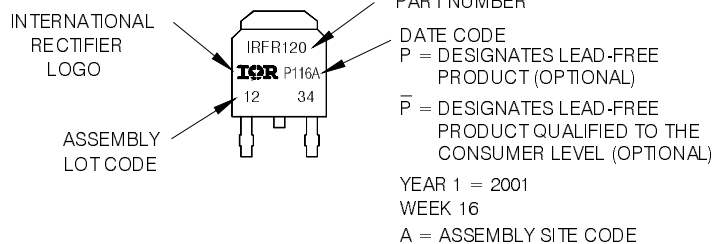

Note: For the most current drawing please refer to IR website at <http://www.irf.com/package/>

I-Pak (TO-251AA) Package Outline

Dimensions are shown in millimeters (inches)

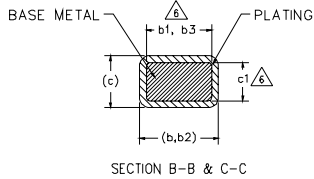
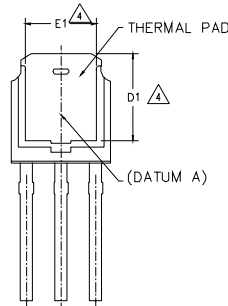
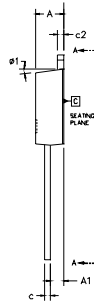
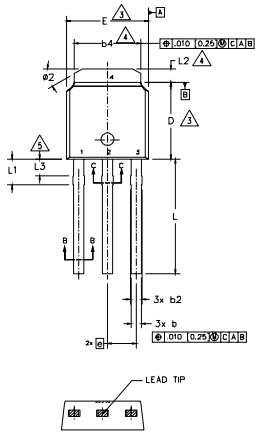

- NOTES:
- 1.- DIMENSIONING AND TOLERANCING PER ASME Y14.5M-1994
 - 2.- DIMENSION ARE SHOWN IN INCHES [MILLIMETERS]
 - △ DIMENSION D & E DO NOT INCLUDE MOLD FLASH. MOLD FLASH SHALL NOT EXCEED .005 [0.13] PER SIDE. THESE DIMENSIONS ARE MEASURED AT THE OUTMOST EXTREMES OF THE PLASTIC BODY.
 - △ THERMAL PAD CONTOUR OPTION WITHIN DIMENSION b4, L2, E1 & D1.
 - △ LEAD DIMENSION UNCONTROLLED IN L3.
 - △ DIMENSION b1, b3 & c1 APPLY TO BASE METAL ONLY.
 - 7.- OUTLINE CONFORMS TO JEDEC OUTLINE TO-251AA (Date 06/02).
 - 8.- CONTROLLING DIMENSION : INCHES.

SYMBOL	DIMENSIONS				NOTES
	MILLIMETERS		INCHES		
	MIN.	MAX.	MIN.	MAX.	
A	2.18	2.39	.086	.094	
A1	0.89	1.14	.035	.045	
b	0.64	0.89	.025	.035	
b1	0.65	0.79	.025	.031	6
b2	0.76	1.14	.030	.045	
b3	0.76	1.04	.030	.041	6
b4	4.95	5.46	.195	.215	4
c	0.46	0.61	.018	.024	
c1	0.41	0.56	.016	.022	6
c2	0.46	0.89	.018	.035	
D	5.97	6.22	.235	.245	3
D1	5.21	-	.205	-	4
E	6.35	6.73	.250	.265	3
E1	4.32	-	.170	-	4
e	2.29 BSC		.090 BSC		
L	8.89	9.65	.350	.380	
L1	1.91	2.29	.045	.090	
L2	0.89	1.27	.035	.050	4
L3	1.14	1.52	.045	.060	5
ø1	0"	15"	0"	15"	
ø2	25"	35"	25"	35"	

LEAD ASSIGNMENTS

HEXFET

- 1.- GATE
- 2.- DRAIN
- 3.- SOURCE
- 4.- DRAIN

I-Pak (TO-251AA) Part Marking Information

EXAMPLE: THIS IS AN IRFU120 WITH ASSEMBLY LOT CODE 5678 ASSEMBLED ON WW 19, 2001 IN THE ASSEMBLY LINE "A"

Note: "P" in assembly line position indicates Lead-Free

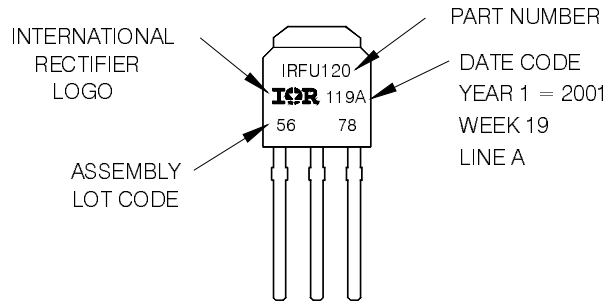

OR

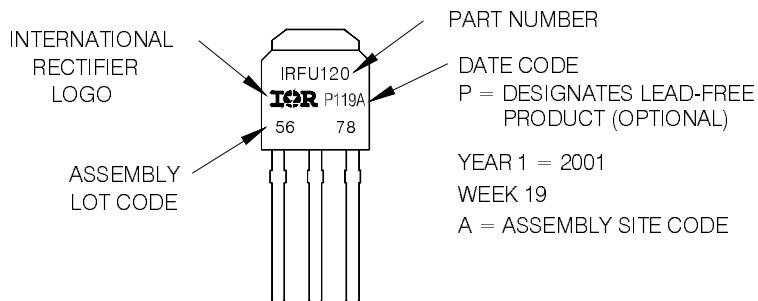

D-Pak (TO-252AA) Tape & Reel Information

Dimensions are shown in millimeters (inches)

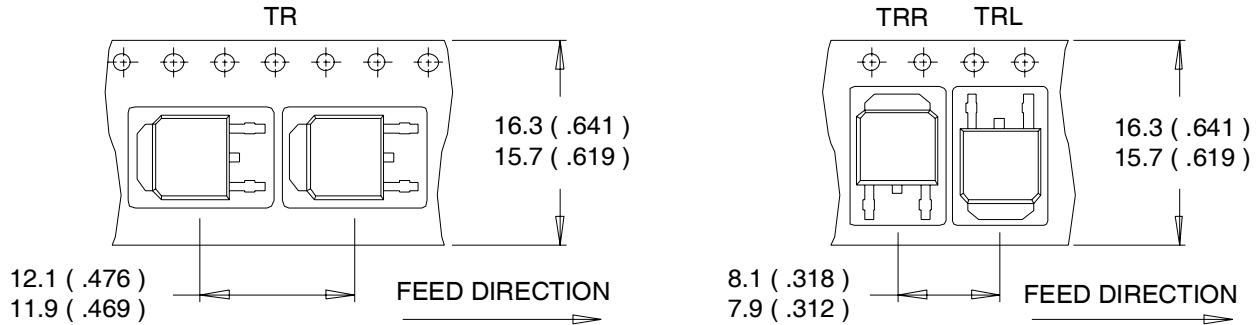

NOTES :

1. CONTROLLING DIMENSION : MILLIMETER.
2. ALL DIMENSIONS ARE SHOWN IN MILLIMETERS (INCHES).
3. OUTLINE CONFORMS TO EIA-481 & EIA-541.

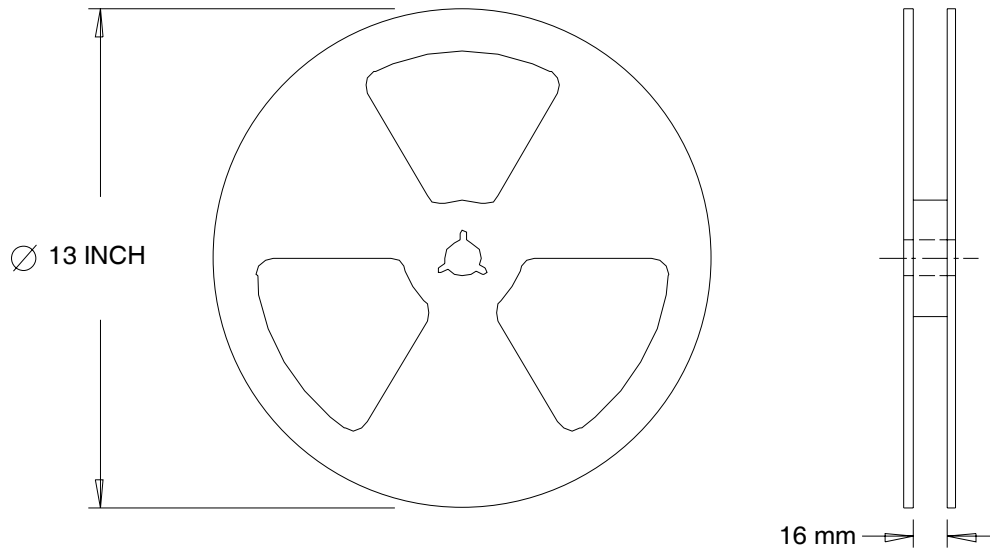

NOTES :

1. OUTLINE CONFORMS TO EIA-481.

Note: For the most current drawing please refer to IR website at <http://www.irf.com/package/>

Data and specifications subject to change without notice.
 This product has been designed and qualified for the Industrial market.
 Qualification Standards can be found on IR's Web site.