

## **Not Recommended for New Designs**

---

This product was manufactured for Maxim by an outside wafer foundry using a process that is no longer available. It is not recommended for new designs. The data sheet remains available for existing users.

A Maxim replacement or an industry second-source may be available. Please see the QuickView data sheet for this part or contact technical support for assistance.

For further information, [contact Maxim's Applications Tech Support](#).

# MAXIM

## Low-Noise Precision Operational Amplifiers

OP27/OP37

### General Description

The OP27/OP37 precision operational amplifiers provide lower noise and higher speed with the same input offset and drift specifications as the OP07. Both parts have a  $10\mu\text{V}$  offset,  $0.2\mu\text{V}/^\circ\text{C}$  drift, and 1.8 million gain. Coupled with a low-voltage noise of  $3.5\text{nV}/\sqrt{\text{Hz}}$  at 10Hz and a low  $1/f$  noise corner frequency of 2.7Hz, the OP27/OP37 are optimized for accurate amplification of low-level signals. The OP27 features an 8MHz gain-bandwidth product and a  $2.8\text{V}/\mu\text{s}$  slew rate. For applications demanding higher speed, the OP37 has a 63MHz gain-bandwidth product,  $17\text{V}/\mu\text{s}$  slew rate, and is stable at gains of five or more.

An output swing of  $\pm 10\text{V}$  into  $600\Omega$  together with low distortion make the OP27/OP37 ideal for professional audio applications.

For applications requiring greater precision or lower noise than the OP27 or OP37, see the MAX427/MAX437 and the MAX410/MAX412/MAX414 data sheets.

### Applications

- Low-Noise DC Amplifiers
- Microphone Amplifiers
- Precision Amplifiers
- Tape-Head Preamplifiers
- Thermocouple Amplifiers
- Low-Level Signal Processing
- Medical Instrumentation
- Strain-Gauge Amplifiers
- High-Accuracy Data Acquisition

### Typical Application Circuit

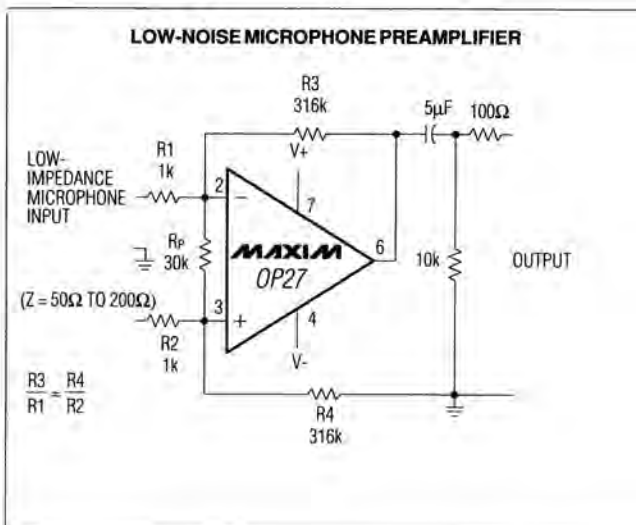

### Features

- ◆  $10\mu\text{V}$  Input Offset Voltage
- ◆  $0.2\mu\text{V}/^\circ\text{C}$  Drift
- ◆  $3\text{nV}/\sqrt{\text{Hz}}$  Input Noise Voltage (1kHz)
- ◆  $80\text{nV}_{\text{p-p}}$  Noise (0.1Hz to 10Hz)
- ◆  $2.8\text{V}/\mu\text{s}$  Slew Rate (OP27)
- ◆  $17\text{V}/\mu\text{s}$  Slew Rate (OP37)
- ◆ 8MHz Gain-Bandwidth Product (OP27)
- ◆ 63MHz Gain-Bandwidth Product (OP37)

### Ordering Information

PART	TEMP. RANGE	PIN-PACKAGE
OP27EP	$0^\circ\text{C}$ to $+70^\circ\text{C}$	8 Plastic DIP
OP27FP	$0^\circ\text{C}$ to $+70^\circ\text{C}$	8 Plastic DIP
OP27GP	$-40^\circ\text{C}$ to $+85^\circ\text{C}$	8 Plastic DIP
OP27GS	$-40^\circ\text{C}$ to $+85^\circ\text{C}$	8 SO
OP27EZ	$-40^\circ\text{C}$ to $+85^\circ\text{C}$	8 CERDIP
OP27FZ	$-40^\circ\text{C}$ to $+85^\circ\text{C}$	8 CERDIP
OP27GZ	$-40^\circ\text{C}$ to $+85^\circ\text{C}$	8 CERDIP
OP27EJ	$-40^\circ\text{C}$ to $+85^\circ\text{C}$	8 TO-99
OP27FJ	$-40^\circ\text{C}$ to $+85^\circ\text{C}$	8 TO-99

Ordering Information continued on last page.

### Pin Configurations

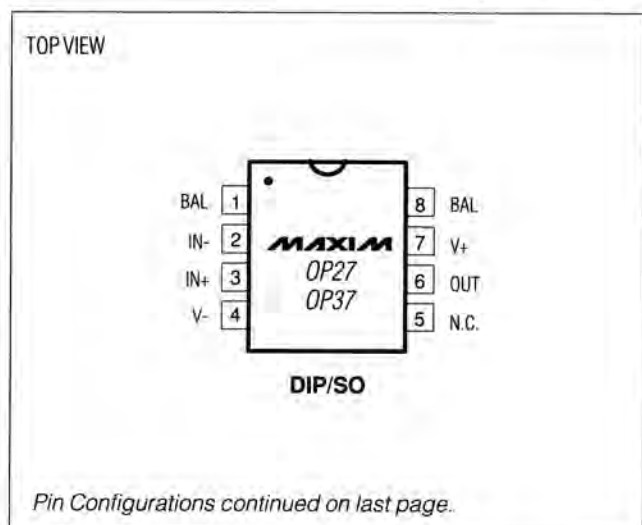

# Low-Noise Precision Operational Amplifiers

## ABSOLUTE MAXIMUM RATINGS

Supply Voltage	±22V
Input Voltage (Note 1)	±22V
Output Short-Circuit Duration	Continuous
Differential Input Voltage (Note 2)	±0.7V
Differential Input Current (Note 2)	±25mA
Continuous Power Dissipation (T <sub>A</sub> = +70°C)	
Plastic DIP (derate 9.09mW/°C above +70°C)	727mW
SO (derate 5.88mW/°C above +70°C)	471mW
CERDIP (derate 8.00mW/°C above +70°C)	640mW
TO-99 (derate 6.67mW/°C above +70°C)	533mW

### Operating Temperature Ranges:

OP27/OP37EP/FP	0°C to +70°C
OP27/OP37G_/EZ/EJ/FZ/FJ	-40°C to +85°C
OP27/OP37A_/B_/C_	-55°C to +125°C
Junction Temperature Range	-65°C to +150°C
Storage Temperature Range	-65°C to +150°C
Lead Temperature (soldering, 10 sec)	+300°C

**Note 1:** For supply voltages less than ±22V, the absolute maximum input voltage is equal to the supply voltage.

**Note 2:** OP27/OP37 inputs are protected by back-to-back diodes. Current-limiting resistors are not used in order to achieve low noise. If differential input voltage exceeds ±0.7V, the input current should be limited to 25mA.

*Stresses beyond those listed under "Absolute Maximum Ratings" may cause permanent damage to the device. These are stress ratings only, and functional operation of the device at these or any other conditions beyond those indicated in the operational sections of the specifications is not implied. Exposure to absolute maximum rating conditions for extended periods may affect device reliability.*

## ELECTRICAL CHARACTERISTICS

(V<sub>S</sub> = ±15V, T<sub>A</sub> = +25°C, unless otherwise noted.)

PARAMETER	SYMBOL	CONDITIONS	OP27A/E OP37A/E			OP27B/F OP37B/F			OP27C/G OP37C/G			UNITS
			MIN	TYP	MAX	MIN	TYP	MAX	MIN	TYP	MAX	
Input Offset Voltage (Note 3)	V <sub>OS</sub>		10	25		20	60		30	100	μV	
Long-Term V <sub>OS</sub> Stability (Notes 4, 5)	V <sub>OS</sub> /TIME		0.2	1.0		0.3	1.5		0.4	2.0	μV/Mo	
Input Bias Current	I <sub>B</sub>		±10	±40		±12	±55		±15	±80	nA	
Input Offset Current	I <sub>OS</sub>		7	35		9	50		12	75	nA	
Input Voltage Range	I <sub>VR</sub>		±11.0	±12.3		±11.0	±12.3		±11.0	±12.3	V	
Input Resistance - Differential Mode (Note 6)	R <sub>IN</sub>		1.3	6		0.94	5		0.7	4	MΩ	
Input Resistance - Common Mode	R <sub>INCM</sub>		3			2.5			2		GΩ	
Input Noise Voltage (Notes 5, 7)	e <sub>np-p</sub>	0.1Hz to 10Hz	0.08	0.18		0.08	0.18		0.09	0.25	μV <sub>P-P</sub>	
Input Noise-Voltage Density (Note 5)	e <sub>n</sub>	f <sub>o</sub> = 10Hz	3.5	5.5		3.5	5.5		3.8	8.0	nV/√Hz	
		f <sub>o</sub> = 30Hz	3.1	4.5		3.1	4.5		3.3	5.6		
		f <sub>o</sub> = 1kHz	3.0	3.8		3.0	3.8		3.2	4.5		
Input Noise-Current Density (Notes 5, 8)	i <sub>n</sub>	f <sub>o</sub> = 10Hz	1.7	4.0		1.7	4.0		1.7		pA/√Hz	
		f <sub>o</sub> = 30Hz	1.0	2.3		1.0	2.3		1.0			
		f <sub>o</sub> = 1kHz	0.4	0.6		0.4	0.6		0.4	0.6		
Large-Signal Voltage Gain	A <sub>VO</sub>	R <sub>L</sub> ≥ 2kΩ, V <sub>O</sub> = ±10V	1000	1800		1000	1800		700	1500	V/mV	
		R <sub>L</sub> ≥ 1kΩ, V <sub>O</sub> = ±10V	800	1500		800	1500		400	1500		
		R <sub>L</sub> ≥ 600Ω, V <sub>O</sub> = ±1V, V <sub>S</sub> = ±4V (Note 5)	250	700		250	700		200	500		
Output Voltage Swing	V <sub>O</sub>	R <sub>L</sub> ≥ 2kΩ	±12.0	±13.8		±12.0	±13.8		±11.5	±13.5	V	
		R <sub>L</sub> ≥ 600Ω	±10.0	±11.5		±10.0	±11.5		±10.0	±11.5		

# Low-Noise Precision Operational Amplifiers

OP27/OP37

## ELECTRICAL CHARACTERISTICS (continued)

( $V_S = \pm 15V$ ,  $T_A = +25^\circ C$ , unless otherwise noted.)

PARAMETER	SYMBOL	CONDITIONS	OP27A/E OP37A/E			OP27B/F OP37B/F			OP27C/G OP37C/G			UNITS
			MIN	TYP	MAX	MIN	TYP	MAX	MIN	TYP	MAX	
Open-Loop Output Resistance	$R_O$	$V_O = 0$ , $I_O = 0$	70			70			70			$\Omega$
Common-Mode Rejection Ratio	CMRR	$V_{CM} = \pm 11V$	114	126		106	123		100	120		dB
Power-Supply Rejection Ratio	PSRR	$V_S = \pm 4V$ to $\pm 18V$	1 10			1 10			2 20			$\mu V/V$
Gain-Bandwidth Product (Note 5)	GBP	$f_o = 100kHz$ , OP27	5.0	8.0		5.0	8.0		5.0	8.0		MHz
		$f_o = 10kHz$ , $A_{VCL} \geq 5$ , OP37	45	63		45	63		45	63		
		$f_o = 1MHz$ , $A_{VCL} \geq 5$ , OP37	40			40			40			
Slew Rate (Note 5)	SR	$R_L \geq 2k\Omega$ , OP27	1.7	2.8		1.7	2.8		1.7	2.8		$V/\mu s$
		$R_L \geq 2k\Omega$ , $A_{VCL} \geq 5$ , OP37	11	17		11	17		11	17		
Power Dissipation	PD	$V_O = 0$	90 140			90 140			100 170			mW
Offset Adjustment Range		$R_P = 10k\Omega$	$\pm 4.0$			$\pm 4.0$			$\pm 4.0$			mV

## ELECTRICAL CHARACTERISTICS

( $V_S = \pm 15V$ ,  $T_A = T_{MIN}$  to  $T_{MAX}$ , unless otherwise noted.)

PARAMETER	SYMBOL	CONDITIONS	OP27A OP37A			OP27B OP37B			OP27C OP37C			UNITS
			MIN	TYP	MAX	MIN	TYP	MAX	MIN	TYP	MAX	
Input Offset Voltage (Note 3)	$V_{OS}$		30	60		50	200		70	300	$\mu V$	
Average-Offset Voltage Drift (Note 9)	$TCV_{OS}$		0.2	0.6		0.3	1.3		0.4	1.8	$\mu V/^\circ C$	
Input Bias Current	$I_B$		$\pm 20$	$\pm 60$		$\pm 28$	$\pm 95$		$\pm 35$	$\pm 150$	nA	
Input Offset Current	$I_{OS}$		10	50		14	85		20	135	nA	
Input Voltage Range	$I_{VR}$		$\pm 10.3$	$\pm 11.5$		$\pm 10.3$	$\pm 11.5$		$\pm 10.2$	$\pm 11.5$	V	
Large-Signal Voltage Gain	$A_{VO}$	$R_L \geq 2k\Omega$ , $V_O = \pm 10V$	600	1200		500	1000		300	800	$V/mV$	
Maximum Output-Voltage Swing	$V_O$	$R_L \geq 2k\Omega$	$\pm 11.5$	$\pm 13.5$		$\pm 11.0$	$\pm 13.2$		$\pm 10.5$	$\pm 13.0$	V	
Common-Mode Rejection Ratio	CMRR	$V_{CM} = \pm 10V$	108	122		100	119		94	116	dB	
Power-Supply Rejection Ratio	PSRR	$V_S = \pm 4.5V$ to $\pm 18V$	2 16			2 20			4 51			$\mu V/V$

# Low-Noise Precision Operational Amplifiers

## ELECTRICAL CHARACTERISTICS (continued)

( $V_S = \pm 15V$ ,  $T_A = T_{MIN}$  to  $T_{MAX}$ , unless otherwise noted.)

PARAMETER	SYMBOL	CONDITIONS	OP27E OP37E			OP27F OP37F			OP27G OP37G			UNITS
			MIN	TYP	MAX	MIN	TYP	MAX	MIN	TYP	MAX	
Input Offset Voltage (Note 3)	$V_{OS}$			20	50		40	140		55	220	$\mu V$
Average Offset-Voltage Drift (Note 9)	$TCV_{OS}$			0.2	0.6		0.3	1.3		0.4	1.8	$\mu V/^\circ C$
Input Bias Current	$I_B$			$\pm 14$	$\pm 60$		$\pm 18$	$\pm 95$		$\pm 25$	$\pm 150$	nA
Input Offset Current	$I_{OS}$			10	50		14	85		20	135	nA
Input Voltage Range	$I_{VR}$		$\pm 10.5$	$\pm 11.8$		$\pm 10.5$	$\pm 11.8$		$\pm 10.5$	$\pm 11.8$		V
Large-Signal Voltage Gain	$A_{VO}$	$R_L \geq 2k\Omega$ , $V_O = \pm 10V$	750	1500		700	1300		450	1000		V/mV
Output Voltage Swing	$V_O$	$R_L \geq 2k\Omega$	$\pm 11.7$	$\pm 13.6$		$\pm 11.4$	$\pm 13.5$		$\pm 11.0$	$\pm 13.3$		V
Common-Mode Rejection Ratio	CMRR	$V_{CM} = \pm 10V$	110	124		102	121		96	118		dB
Power-Supply Rejection Ratio	PSRR	$V_S = \pm 4.5V$ to $\pm 18V$		2	15		2	16		2	32	$\mu V/V$

**Note 3:**  $V_{OS}$  is measured approximately 0.5 seconds after application of power.

**Note 4:** Long-term input offset voltage stability refers to the average trend line of  $V_{OS}$  vs. Time over extended periods after the first 30 days of operation.

**Note 5:** Guaranteed by design.

**Note 6:** Guaranteed by input bias current.

**Note 7:** See test circuit and frequency response curve for 0.1Hz to 10Hz tester (Figures 1, 6).

**Note 8:** See test circuit for current-noise measurement (Figure 2).

**Note 9:** The  $TCV_{OS}$  performance is within the specifications unnullified or when nulled with  $R_p = 8k\Omega$  to  $20k\Omega$ .  $TCV_{OS}$  is sample tested to 0.1% AQL for A/E grades. B/C/F/G are guaranteed by design.

## Typical Operating Characteristics

( $T_A = +25^\circ C$ , unless otherwise noted)

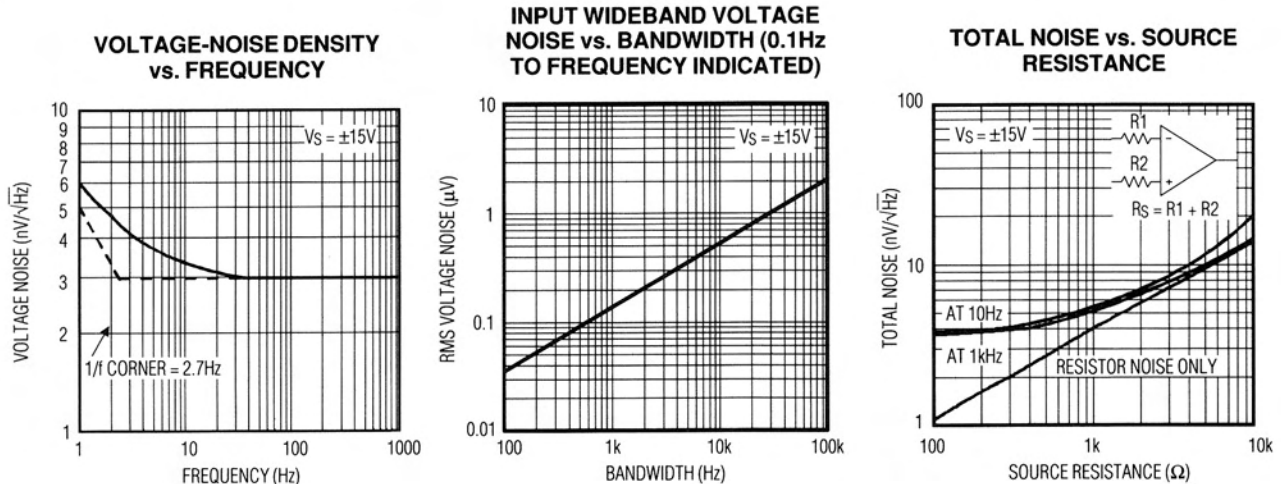

# Low-Noise Precision Operational Amplifiers

## Typical Operating Characteristics (continued)

OP27/OP37

**VOLTAGE-NOISE DENSITY vs. TEMPERATURE**

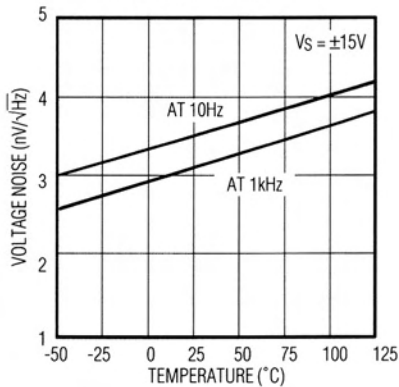

**VOLTAGE-NOISE DENSITY vs. SUPPLY VOLTAGE**

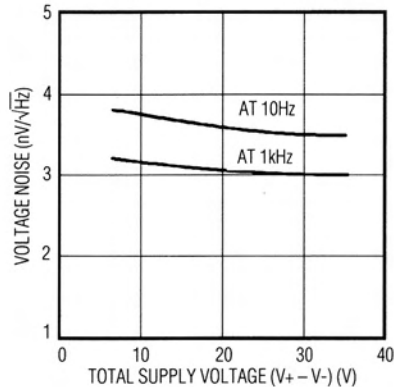

**CURRENT-NOISE DENSITY vs. FREQUENCY**

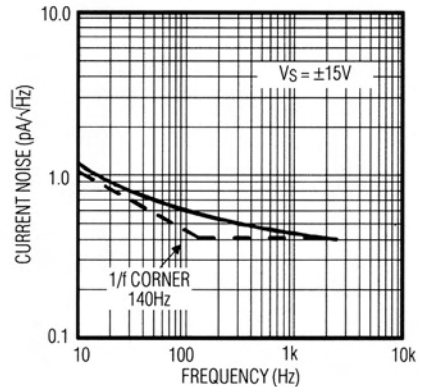

**SUPPLY CURRENT vs. SUPPLY VOLTAGE**

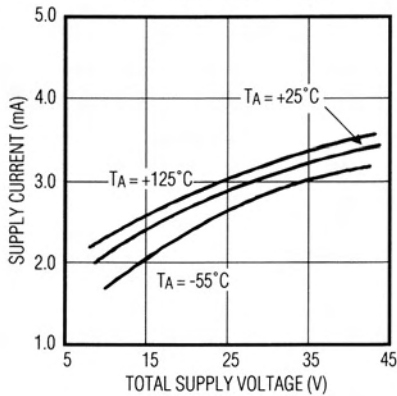

**WARMUP OFFSET VOLTAGE DRIFT**

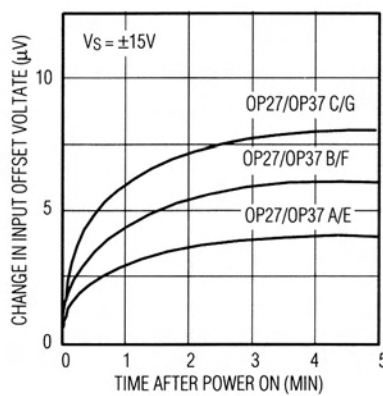

**INPUT BIAS CURRENT vs. TEMPERATURE**

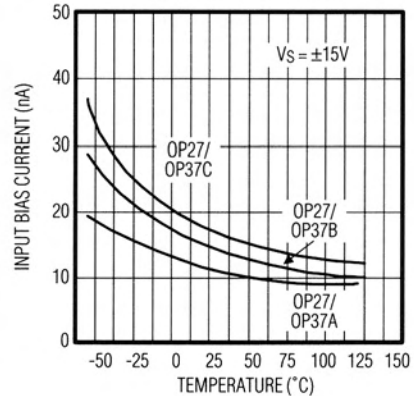

**INPUT OFFSET CURRENT vs. TEMPERATURE**

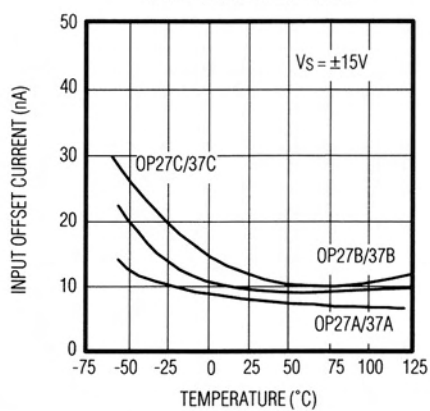

**VOLTAGE GAIN vs. FREQUENCY**

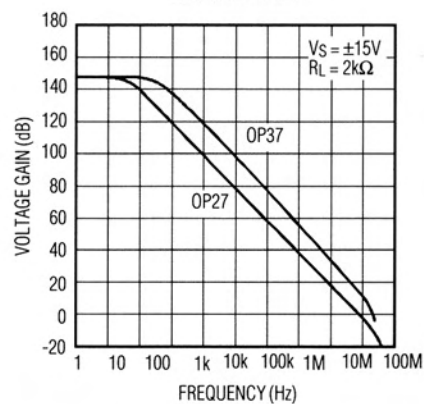

# Low-Noise Precision Operational Amplifiers

## Typical Operating Characteristics (continued)

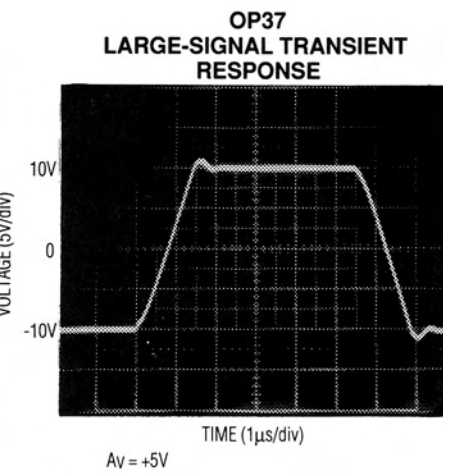
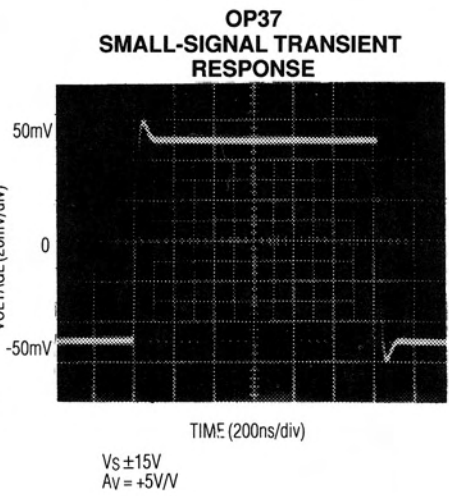
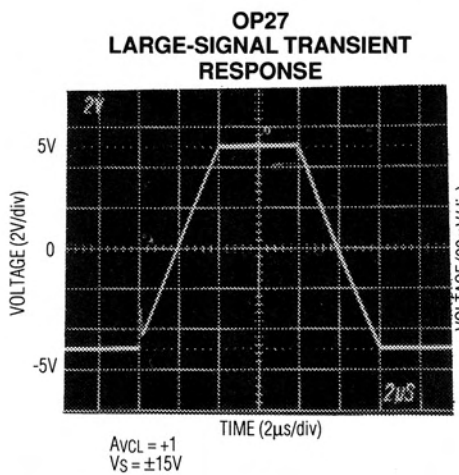
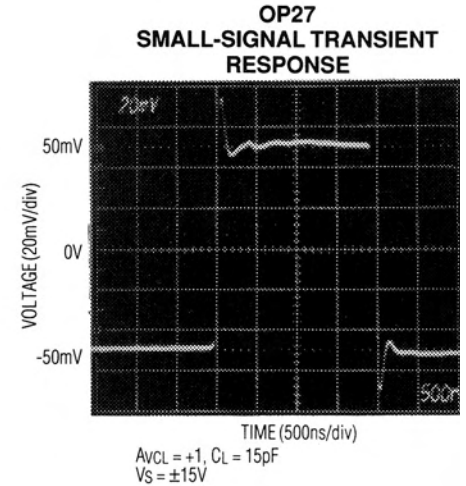
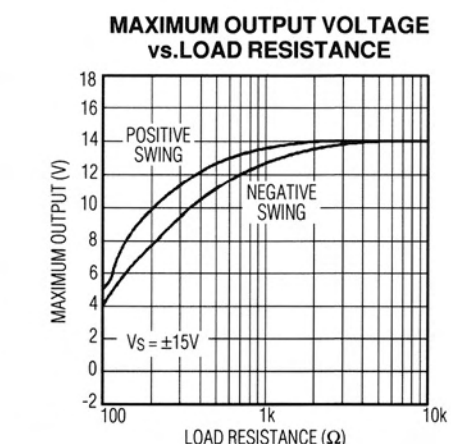
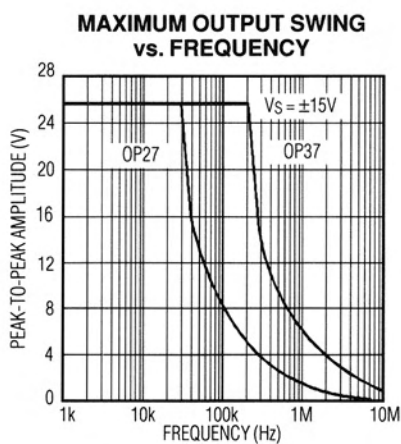
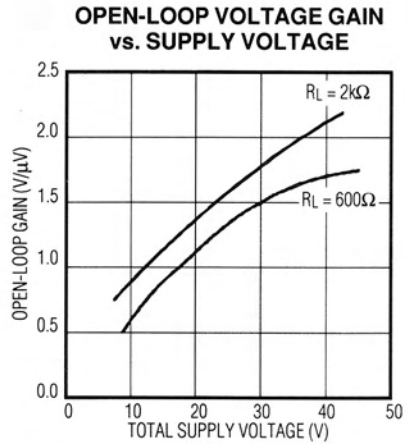
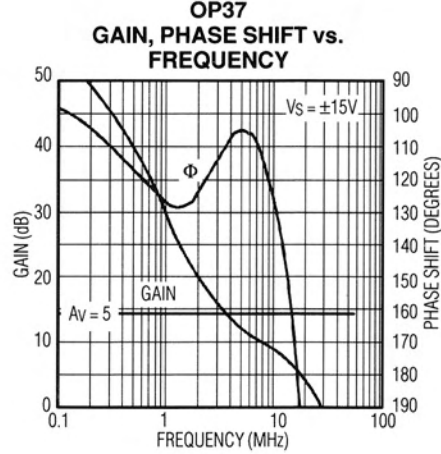
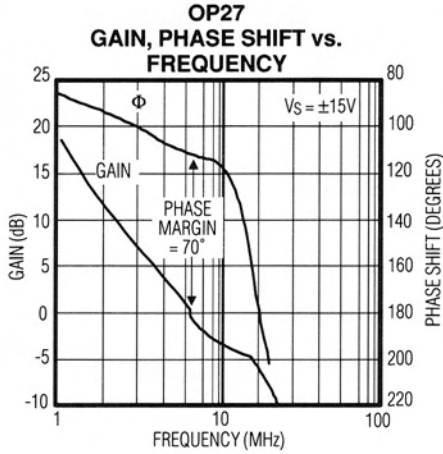

# Low-Noise Precision Operational Amplifiers

## Typical Operating Characteristics (continued)

OP27/OP37

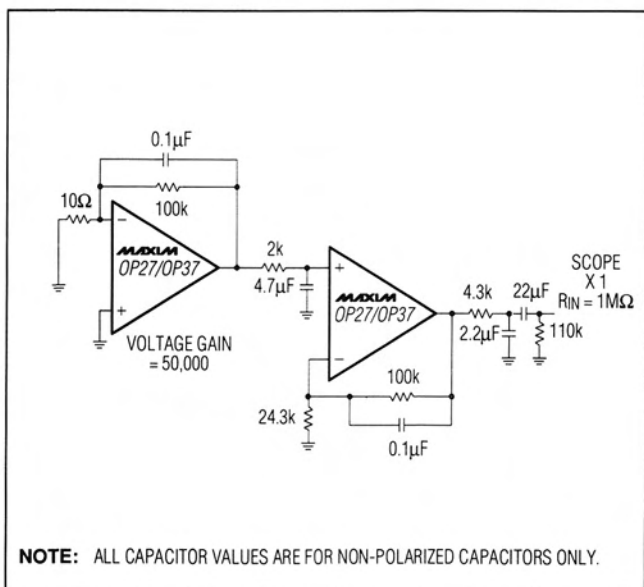
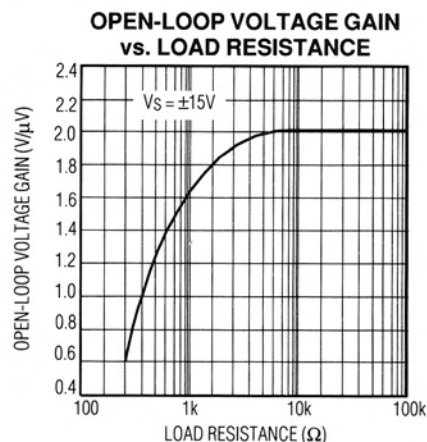
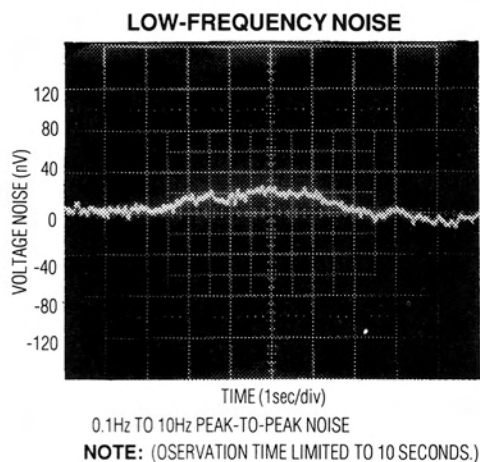

Figure 1. Voltage-Noise Test Circuit (0.1Hz to 10Hz)

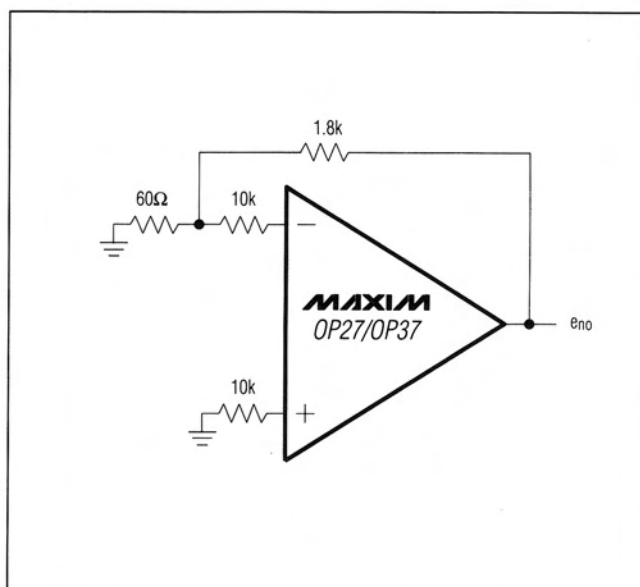

Figure 2. Current-Noise Test Circuit

### Applications Information

The OP27/OP37 provide stable operation with load capacitances of up to 2nF and  $\pm 10V$  output swings; larger capacitances should be decoupled with a  $50\Omega$  series resistor inside the feedback loop. The OP27 is unity-gain stable and the OP37 is stable at gains of five or greater.

Thermoelectric voltages generated by dissimilar metals at the input terminals degrade the drift performance. Connections to both inputs should be maintained at the same temperature for best operation.



# Low-Noise Precision Operational Amplifiers

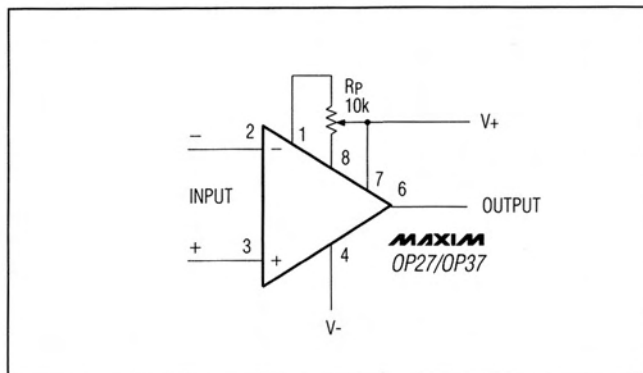

Figure 3. Offset Nulling Circuit

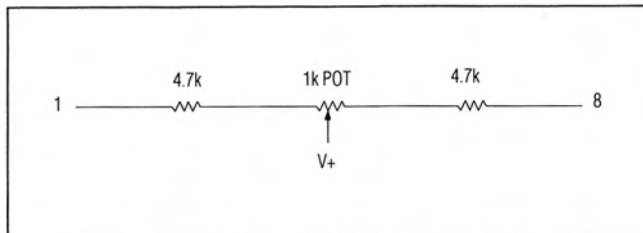

Figure 4. Alternate Offset-Voltage Adjustment

## Offset-Voltage Adjustment

Input offset voltage ( $V_{OS}$ ) is trimmed at the wafer level. If  $V_{OS}$  adjustment is necessary, a  $10k\Omega$  trim potentiometer (pot) may be used and will not degrade  $TCV_{OS}$  (Figure 3). Other trim pot values from  $1k\Omega$  to  $1M\Omega$  can be used with a slight degradation ( $0.1\mu V/^\circ C$  to  $0.2\mu V/^\circ C$ ) of  $TCV_{OS}$ . Adjusting, but not zeroing,  $V_{OS}$  creates a drift of approximately  $(V_{OS}/300)\mu V/^\circ C$ . For example, the change in  $TCV_{OS}$  is  $0.33\mu V/^\circ C$  if  $V_{OS}$  is adjusted to  $100\mu V$ . The adjustment range with a  $10k\Omega$  trim pot is  $\pm 4mV$ . For a smaller range, reduce nulling sensitivity by connecting a smaller pot in series with fixed resistors; for example, Figure 4 has a  $\pm 280\mu V$  adjustment range.

## Noise Measurements

To measure the  $80nV_{p-p}$  noise specification of the OP27/OP37 in the  $0.1Hz$  to  $10Hz$  range, observe the following precautions:

1. The device must warm up for at least five minutes. Figure 5 shows how  $V_{OS}$  typically increases  $4\mu V$  with increases in chip temperature after power-up. In the 10sec measurement interval, temperature-induced effects can exceed  $10nV$ .
2. For similar reasons, the device must be well-shielded from air currents, including those caused by motion. This minimizes thermocouple effects.

3. As shown in Figure 6, the  $0.1Hz$  corner is defined by only one zero. A maximum test time of 10sec acts as an additional zero to eliminate noise contributions from the frequency band below  $0.1Hz$ .

4. A noise-voltage-density test is recommended when measuring noise on a large number of units. A  $10Hz$  noise-voltage-density measurement correlates well with a  $0.1Hz$  to  $10Hz$  peak-to-peak noise reading, since both results are determined by the white noise and the location of the  $1/f$  corner frequency.

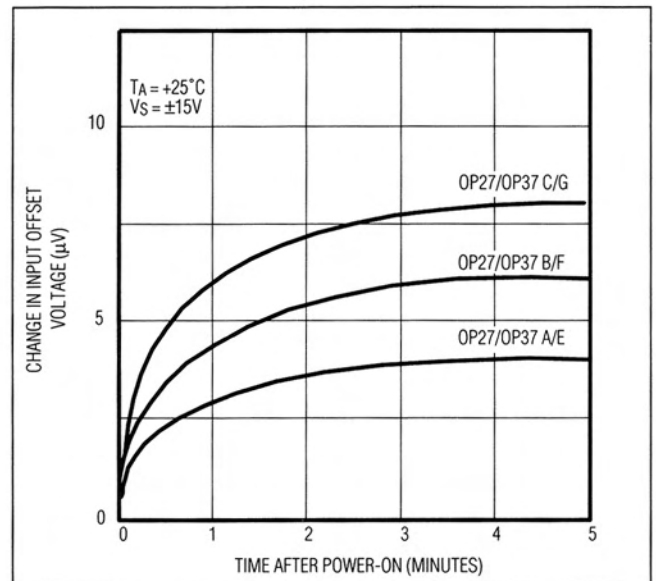

Figure 5. Warm-Up Offset Voltage Drift

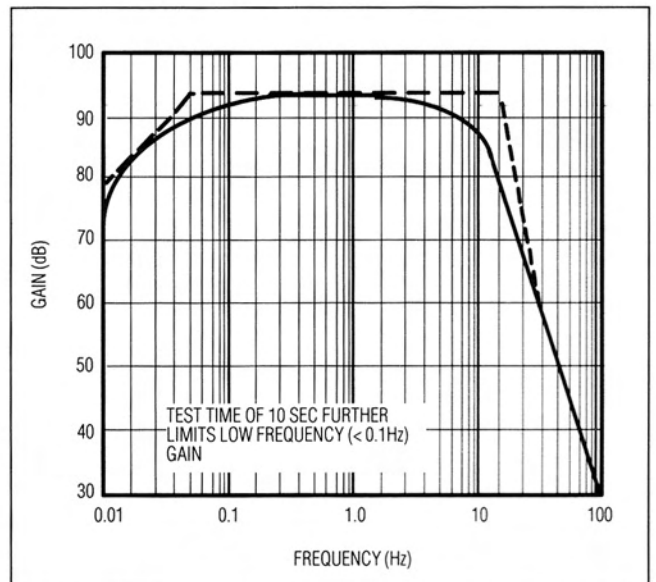

Figure 6.  $0.1Hz$  to  $10Hz$   $V_{p-p}$  Noise Tester Frequency Response

# Low-Noise Precision Operational Amplifiers

OP27/OP37

## Unity-Gain Buffer Applications (OP27 Only)

Figure 7 shows the circuit and output waveform with  $R_f \leq 100\Omega$ , and the input driven with a fast, large signal pulse ( $>1V$ ).

During the fast rise portion of the output, the input protection diodes short the output to the input, and a current, limited only by the output short-circuit protection, is drawn by the signal generator. With  $R_f \geq 500\Omega$ , the output is capable of handling the current required ( $I_L \leq 20mA$  at  $10V$ ) and a smooth transition occurs.

When  $R_f \geq 2k\Omega$ , a pole created with  $R_f$  and the amplifier's input capacitance ( $8pF$ ) causes additional phase shift and reduces phase margin. A small capacitor ( $20pF$ ) in parallel with  $R_f$  eliminates this problem.

## Comments on Noise

The OP27/OP37 are very low-noise amplifiers. They have outstanding input voltage noise characteristics by operating the input stage at a high quiescent current. Input bias and offset currents, which would normally increase with the quiescent current, are minimized by bias-current cancellation circuitry. The OP27/OP37A and E grade devices have  $I_B$  and  $I_{OS}$  of only  $\pm 40nA$  and  $35nA$  respectively at  $+25^\circ C$ . This is particularly important with high source-resistances.

Voltage noise is inversely proportional to the square-root of bias current, but current noise is proportional to the square-root of bias current. The OP27/OP37 low-noise advantages are reduced when high source resistors are used.

$$\text{Total noise} = [(voltage\ noise)^2 + (current\ noise \times R_s)^2 + (resistor\ noise)^2]^{1/2}$$

Figure 8 shows noise vs. source resistance at  $1kHz$ . To use this plot for wideband noise, multiply the vertical scale by the square-root of the bandwidth. The OP27/OP37 maintains low input noise voltage with  $R_s < 1k\Omega$ . With  $R_s > 1k\Omega$ , total noise increases and is dominated by the resistor noise, not the current or the voltage noise. It is only with  $R_s \geq 20k\Omega$  that current noise dominates. Current noise is not important for applications with  $R_s < 20k\Omega$ . The OP27/OP37 has lower total noise than the MAX400/OP07 for  $R_s < 10k\Omega$ . As  $R_s$  increases, the crossover between the OP27/OP37 and the MAX400/OP07 noise occurs in the  $R_s = 15k\Omega$  to  $40k\Omega$  region.

Figure 9 shows  $0.1Hz$  to  $10Hz$  peak-to-peak noise. Here, resistor noise is negligible and current noise ( $i_n$ ) becomes important, because  $i_n \propto 1/\sqrt{f}$ . The crossover with the MAX400/OP07 occurs in the  $R_s = 3k\Omega$  to  $5k\Omega$  range,

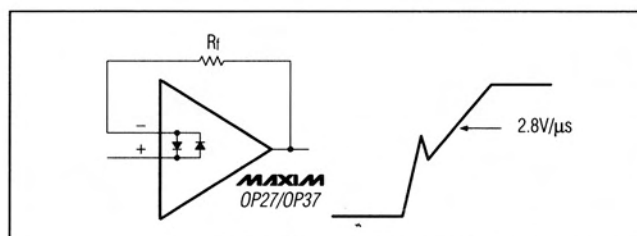

Figure 7. Pulsed Operation of Unity-Gain Buffer

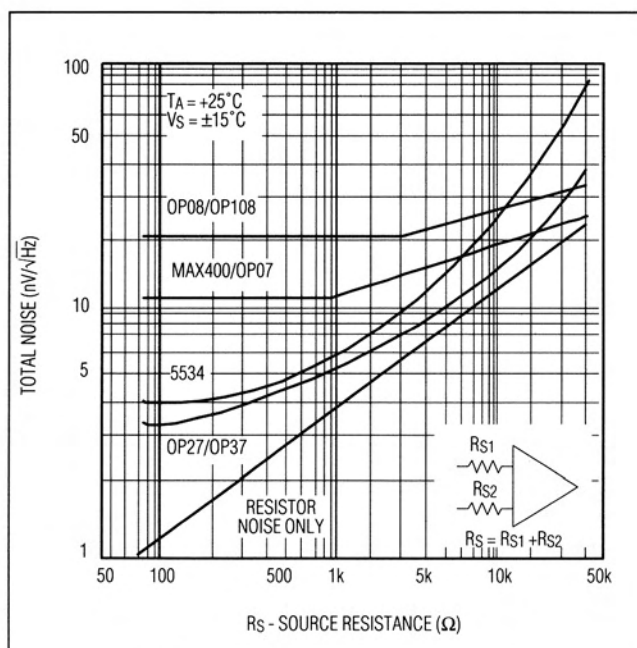

Figure 8. Noise vs. Source Resistance (Including Resistor Noise) at  $1kHz$

depending on whether balanced or unbalanced source resistors are used (at  $3k\Omega$  the  $I_B$  and  $I_{OS}$  error can be three times the  $V_{OS}$  specification). For low-frequency applications, the MAX400/OP07 is better than the OP27/OP37 when  $R_s > 3k\Omega$ , except when gain error is important. Figure 10 illustrates the  $10Hz$  noise. As expected, the results fall between those of the previous two figures.

For reference, typical source resistances of some signal sources are listed in Table 1.

# Low-Noise Precision Operational Amplifiers

**Table 1. Signal Source vs. Source Impedance**

DEVICE	SOURCE IMPEDANCE	COMMENTS
Strain Gauge	<500Ω	Typically used in low-frequency applications.
Magnetic Tapehead	< 1500Ω	Low I <sub>B</sub> is very important to reduce self-magnetization problems when direct coupling is used. OP27 I <sub>B</sub> can be neglected.
Linear Variable Differential Transformer	< 1500Ω	Used in rugged servo-feedback applications. Bandwidth of interest is 400Hz to 5kHz.

**Table 2. Open-Loop Gain vs. Frequency**

FREQUENCY AT:	OPEN-LOOP GAIN		
	OP07	OP27	OP37
3Hz	100dB	124dB	125dB
10Hz	100dB	120dB	125dB
30Hz	90dB	110dB	124dB

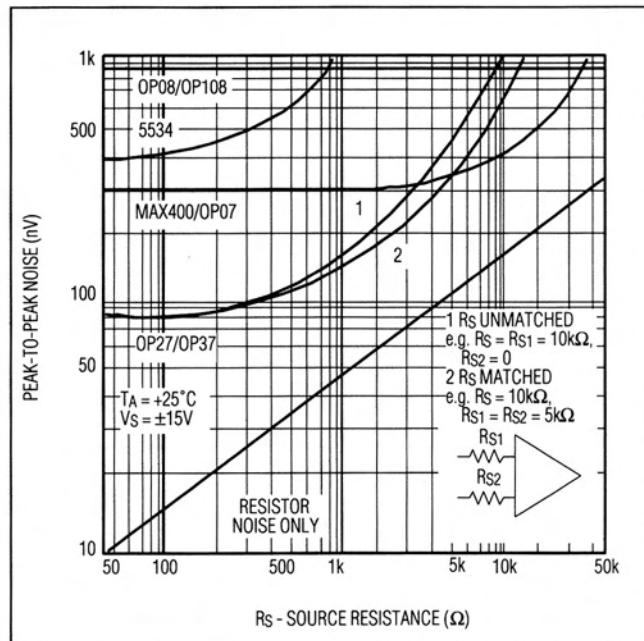

Figure 9. Peak-to-Peak Noise (0.1 to 10Hz) vs. Source Resistance (Includes Resistor Noise)

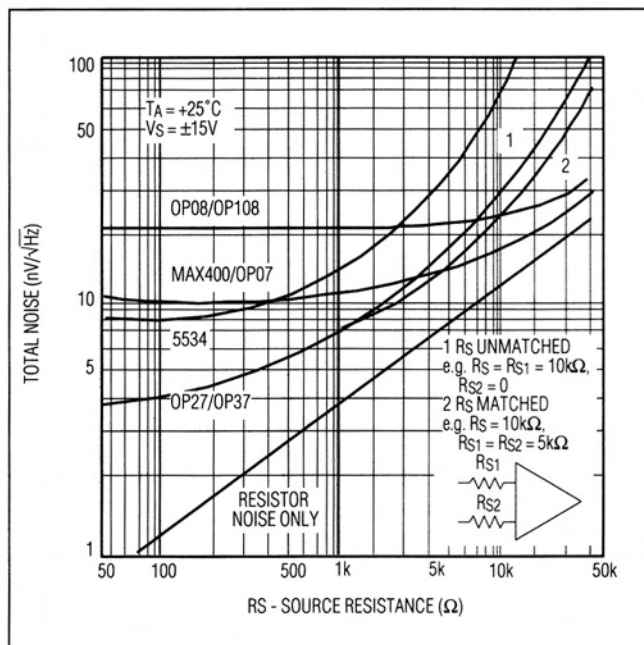

Figure 10. 10Hz Noise vs. Source Resistance (Includes Resistor Noise)

# Low-Noise Precision Operational Amplifiers

**OP27/OP37**

## Ordering Information (continued)

PART	TEMP. RANGE	PIN-PACKAGE
OP27GJ	-40°C to +85°C	8 TO-99
OP27AZ	-55°C to +125°C	8 CERDIP*
OP27BZ	-55°C to +125°C	8 CERDIP*
OP27CZ	-55°C to +125°C	8 CERDIP*
OP27AJ	-55°C to +125°C	8 TO-99*
OP27BJ	-55°C to +125°C	8 TO-99*
OP27CJ	-55°C to +125°C	8 TO-99*
<b>OP37EP</b>	0°C to +70°C	8 Plastic DIP
OP37FP	0°C to +70°C	8 Plastic DIP
OP37GP	-40°C to +85°C	8 Plastic DIP
OP37GS	-40°C to +85°C	8 SO
OP37EZ	-40°C to +85°C	8 CERDIP
OP37FZ	-40°C to +85°C	8 CERDIP
OP37GZ	-40°C to +85°C	8 CERDIP
OP37EJ	-40°C to +85°C	8 TO-99
OP37FJ	-40°C to +85°C	8 TO-99
OP37GJ	-40°C to +85°C	8 TO-99
OP37AZ	-55°C to +125°C	8 CERDIP*
OP37BZ	-55°C to +125°C	8 CERDIP*
OP37CZ	-55°C to +125°C	8 CERDIP*
OP37AJ	-55°C to +125°C	8 TO-99*
OP37BJ	-55°C to +125°C	8 TO-99*
OP37CJ	-55°C to +125°C	8 TO-99*

\*Contact factory for availability and processing to MIL-STD-883.

## Chip Topography

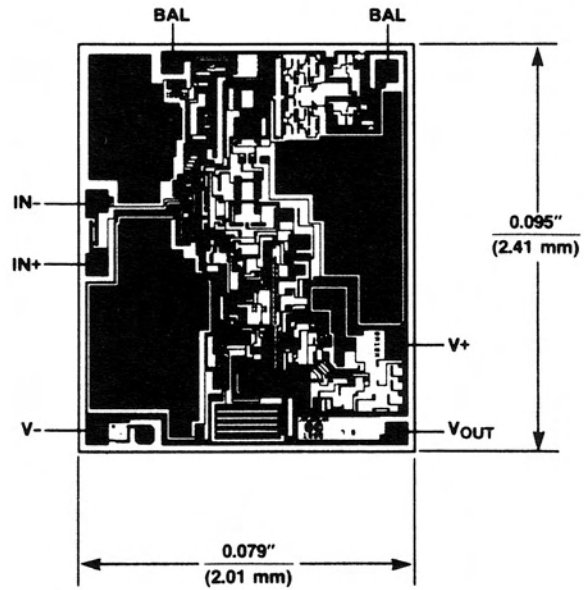

OP27/OP37

SUBSTRATE CONNECTED TO V-

## Pin Configurations (continued)

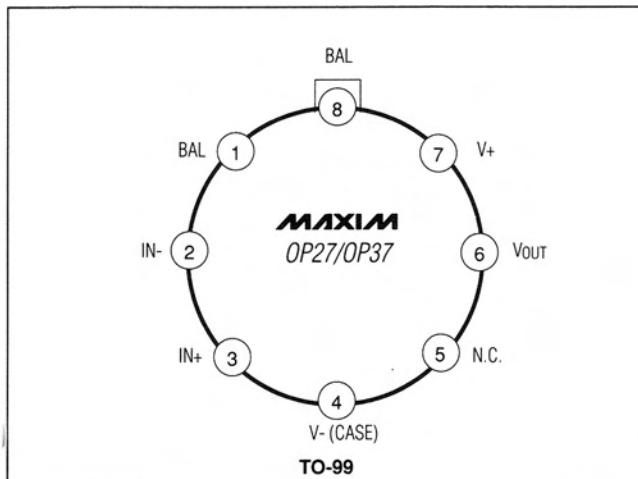

# Low-Noise Precision Operational Amplifiers

## Package Information

(The package drawing(s) in this data sheet may not reflect the most current specifications. For the latest package outline information go to [www.maxim-ic.com/packages](http://www.maxim-ic.com/packages).)

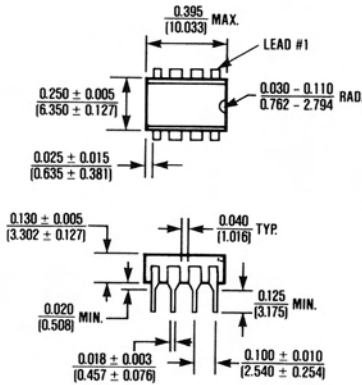

**8 Lead Plastic DIP**  
 $\theta_{JA} = 120^{\circ}\text{C/W}$   
 $\theta_{JC} = 70^{\circ}\text{C/W}$

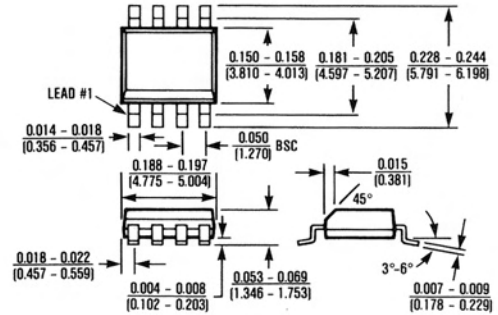

**8 Lead Small Outline**  
 $\theta_{JA} = 170^{\circ}\text{C/W}$   
 $\theta_{JC} = 80^{\circ}\text{C/W}$

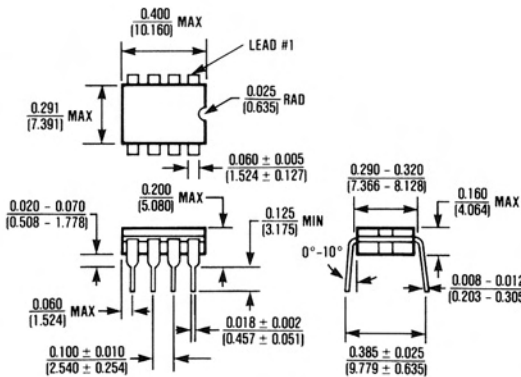

**8 Lead Cerdip**  
 $\theta_{JA} = 125^{\circ}\text{C/W}$   
 $\theta_{JC} = 55^{\circ}\text{C/W}$

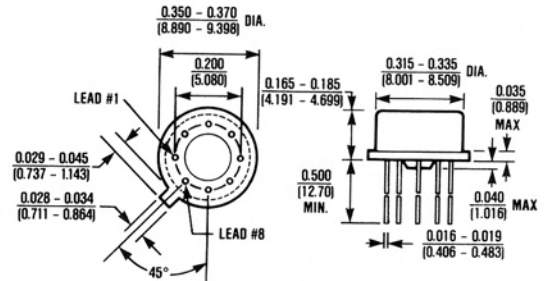

**8 Lead TO-99**  
 $\theta_{JA} = 150^{\circ}\text{C/W}$   
 $\theta_{JC} = 45^{\circ}\text{C/W}$

Maxim cannot assume responsibility for use of any circuitry other than circuitry entirely embodied in a Maxim product. No circuit patent licenses are implied. Maxim reserves the right to change the circuitry and specifications without notice at any time.

12 **Maxim Integrated Products, 120 San Gabriel Drive, Sunnyvale, CA 94086 (408) 737-7600**

# Mouser Electronics

Authorized Distributor

Click to View Pricing, Inventory, Delivery & Lifecycle Information:

## Analog Devices Inc.:

[OP27AJ/883C](#) [OP27GPZ](#) [OP27GSZ-REEL](#) [OP27AZ](#) [OP27GSZ-REEL7](#) [OP27GJZ](#) [OP27EPZ](#) [OP27GSZ](#)  
[OP27GZ](#) [OP27AZ/883C](#) [OP27EZ](#)