



Dual, Low-Dropout, 100mA Linear Regulators

General Description

The MAX8865 and MAX8866 dual, low-dropout linear regulators operate from a +2.5V to +5.5V input range and deliver up to 100mA. At 200mA total load, the PMOS pass transistors keep the supply current at 145µA, making these devices ideal for battery-operated portable equipment such as cellular phones, cordless phones, and modems.

The devices feature Dual Mode™ operation: their output voltages are preset (at 3.15V for the "T" versions, 2.84V for the "S" versions, or 2.80V for the "R" versions) or can be adjusted with external resistor dividers. Other features include independent low-power shutdown, short-circuit protection, thermal shutdown protection, and reverse battery protection. The MAX8866 also includes an auto-discharge function, which actively discharges the selected output voltage to ground when the device is placed in shutdown mode. Both devices come in a miniature 8-pin µMAX package.

Applications

Cordless Telephones	Modems
PCS Telephones	Hand-Held Instruments
Cellular Telephones	Palmtop Computers
PCMCIA Cards	Electronic Planners

Typical Operating Circuit

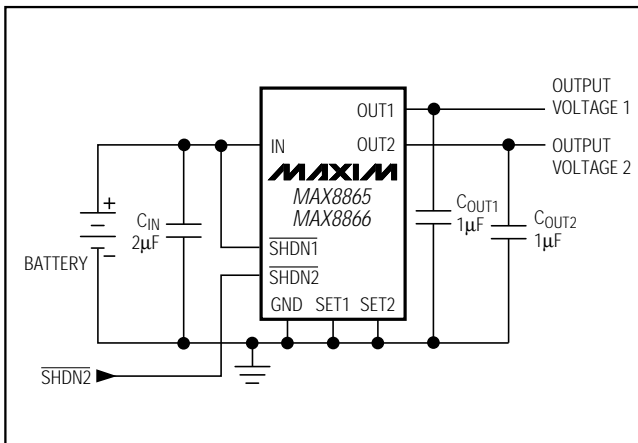

Dual Mode is a trademark of Maxim Integrated Products.

Features

- ◆ **Low Cost**
- ◆ **Low, 55mV Dropout Voltage @ 50mA I_{OUT}**
- ◆ **Low, 105µA No-Load Supply Current**
- ◆ **Low, 145µA Operating Supply Current (even in dropout)**
- ◆ **Low, 350µV_{RMS} Output Noise**
- ◆ **Independent, Low-Current Shutdown Control**
- ◆ **Thermal Overload Protection**
- ◆ **Output Current Limit**
- ◆ **Reverse Battery Protection**
- ◆ **Dual Mode Operation: Fixed or Adjustable (1.25V to 5.5V) Outputs**

Ordering Information

PART	TEMP. RANGE	PIN-PACKAGE	PRESET V _{OUT} (V)
MAX8865TEUA	-40°C to +85°C	8 µMAX	3.15
MAX8865SEUA	-40°C to +85°C	8 µMAX	2.84
MAX8865REUA	-40°C to +85°C	8 µMAX	2.80
MAX8866TEUA	-40°C to +85°C	8 µMAX	3.15
MAX8866SEUA	-40°C to +85°C	8 µMAX	2.84
MAX8866REUA	-40°C to +85°C	8 µMAX	2.80

Pin Configuration

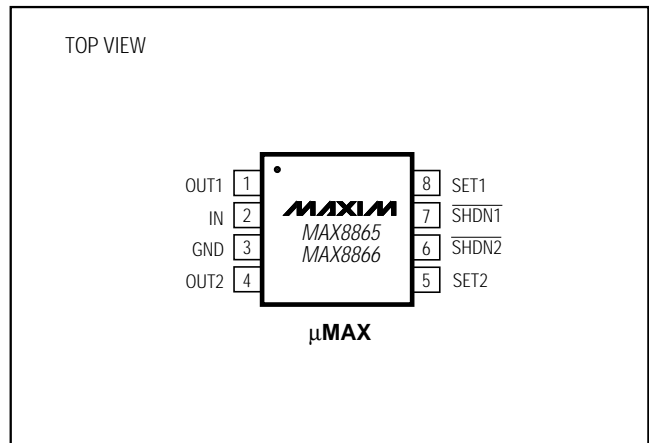

MAX8865T/S/R, MAX8866T/S/R



Dual, Low-Dropout, 100mA Linear Regulators

MAX8865T/S/R, MAX8866T/S/R

ABSOLUTE MAXIMUM RATINGS

V_{IN} to GND	-6V to +6V
Output Short-Circuit Duration	Infinite
SET ₋ to GND	-0.3V to +6V
\overline{SHDN} to GND	-6V to +6V
\overline{SHDN} to IN	-6V to +0.3V
OUT ₋ to GND	-0.3V to ($V_{IN} + 0.3V$)
Continuous Power Dissipation ($T_A = +70^\circ\text{C}$)	
μMAX (derate 4.1mW/ $^\circ\text{C}$ above $+70^\circ\text{C}$)	330mW

Operating Temperature Range	-40 $^\circ\text{C}$ to +85 $^\circ\text{C}$
Junction Temperature	+150 $^\circ\text{C}$
Thermal Resistance (θ_{JA})	244 $^\circ\text{C}/\text{W}$
Storage Temperature Range	-65 $^\circ\text{C}$ to +160 $^\circ\text{C}$
Lead Temperature (soldering, 10sec)	+300 $^\circ\text{C}$

Stresses beyond those listed under "Absolute Maximum Ratings" may cause permanent damage to the device. These are stress ratings only, and functional operation of the device at these or any other conditions beyond those indicated in the operational sections of the specifications is not implied. Exposure to absolute maximum rating conditions for extended periods may affect device reliability.

ELECTRICAL CHARACTERISTICS

($V_{IN} = +3.6V$, GND = 0V, $T_A = 0^\circ\text{C}$ to +85 $^\circ\text{C}$, unless otherwise noted. Typical values are at $T_A = +25^\circ\text{C}$.)

PARAMETER	SYMBOL	CONDITIONS	MIN	TYP	MAX	UNITS	
Input Voltage (Note 1)	V_{IN}		2.5		5.5	V	
Output Voltage	V_{OUT-}	0mA \leq $I_{OUT} \leq$ 50mA, SET ₋ = GND	MAX886_T	3.08	3.15	3.24	V
			MAX886_S	2.77	2.84	2.91	
			MAX886_R	2.73	2.80	2.87	
Adjustable Output Voltage Range (Note 2)	V_{OUT-}		V_{SET-}		5.5	V	
Maximum Output Current			100			mA	
Current Limit (Note 3)	I_{LIM}			220		mA	
Ground Pin Current	I_Q	SET ₋ = GND	$I_{OUT-} = 0\text{mA}$	105	270	μA	
			$I_{OUT-} = 50\text{mA}$	145			
Dropout Voltage (Note 4)		$I_{OUT} = 1\text{mA}$		1.1		mV	
		$I_{OUT} = 50\text{mA}$		55	120		
Line Regulation	ΔV_{LNR}	$V_{IN} = 2.5V$ to 5.5V, SET ₋ tied to OUT ₋ , $I_{OUT-} = 1\text{mA}$	-0.10	0	0.10	%/V	
Load Regulation	ΔV_{LDR}	$I_{OUT-} = 0\text{mA}$ to 50mA	SET ₋ = GND	0.012	0.03	%mA	
			SET ₋ tied to OUT ₋	0.006			
Output Voltage Noise		10Hz to 1MHz	$C_{OUT} = 1\mu\text{F}$	350		μVRMS	
			$C_{OUT} = 100\mu\text{F}$	220			
SHUTDOWN							
\overline{SHDN} Input Threshold	V_{IH}		2.0			V	
	V_{IL}			0.4			
\overline{SHDN} Input Bias Current	$I_{\overline{SHDN}}$	$V_{\overline{SHDN}} = V_{IN}$		0	1000	nA	
Shutdown Supply Current	$I_Q \overline{SHDN}$	$V_{OUT-} = 0V$		0.16	3000	nA	
Shutdown to Output Discharge Delay (MAX8866)		$C_{OUT} = 1\mu\text{F}$, no load		1		ms	
SET INPUT							
SET Reference Voltage (Note 2)	V_{SET-}	$V_{IN} = 2.5V$ to 5.5V, $I_{OUT-} = 1\text{mA}$	1.222	1.25	1.276	V	
SET Input Leakage Current (Note 2)	I_{SET-}	$V_{SET-} = 1.3V$		0.015	50	nA	
THERMAL PROTECTION							
Thermal Shutdown Temperature	T_{SHDN}			170		$^\circ\text{C}$	
Thermal Shutdown Hysteresis	ΔT_{SHDN}			20		$^\circ\text{C}$	

Dual, Low-Dropout, 100mA Linear Regulators

MAX8865T/S/R, MAX8866T/S/R

ELECTRICAL CHARACTERISTICS

($V_{IN} = +3.6V$, $GND = 0V$, $T_A = -40^{\circ}C$ to $+85^{\circ}C$, unless otherwise noted. Typical values are at $T_A = +25^{\circ}C$.) (Note 5)

PARAMETER	SYMBOL	CONDITIONS		MIN	TYP	MAX	UNITS
Input Voltage (Note 1)	V_{IN}			2.5		5.5	V
Output Voltage	$V_{OUT_}$	$0mA \leq I_{OUT_} \leq 50mA$, $SET_ = GND$	MAX886_T	3.05	3.15	3.26	V
			MAX886_S	2.74	2.84	2.93	
			MAX886_R	2.70	2.80	2.89	
Adjustable Output Voltage Range (Note 2)	$V_{OUT_}$			$V_{SET_}$		5.5	V
Maximum Output Current				80			mA
Current Limit (Note 3)	I_{LIM}				220		mA
Ground Pin Current	I_Q	$SET_ = GND$	$I_{OUT_} = 0mA$		105	270	μA
			$I_{OUT_} = 50mA$		145		
Dropout Voltage (Note 4)			$I_{OUT_} = 1mA$		1.1		mV
			$I_{OUT_} = 50mA$		55	120	
Line Regulation	ΔV_{LNR}	$V_{IN} = 2.5V$ to $5.5V$, $SET_ \text{ tied to } OUT_$, $I_{OUT_} = 1mA$		-0.11	0	0.11	%/V
Load Regulation	ΔV_{LDR}	$I_{OUT_} = 0mA$ to $50mA$	$SET_ = GND$		0.012	0.03	%mA
			$SET_ \text{ tied to } OUT_$		0.006		
Output Voltage Noise		10Hz to 1MHz	$C_{OUT} = 1\mu F$		350		μV_{RMS}
			$C_{OUT} = 100\mu F$		220		
SHUTDOWN							
\overline{SHDN} Input Threshold	V_{IH}			2.0			V
	V_{IL}					0.4	
\overline{SHDN} Input Bias Current	$I_{\overline{SHDN}}$	$V_{\overline{SHDN}} = V_{IN}$			0	1000	nA
Shutdown Supply Current	$I_Q \text{ SHDN}$	$V_{OUT_} = 0V$			0.16	3000	nA
Shutdown to Output Discharge Delay (MAX8866)		$C_{OUT} = 1\mu F$			1		ms
SET INPUT							
SET Reference Voltage (Note 2)	$V_{SET_}$	$V_{IN} = 2.5V$ to $5.5V$, $I_{OUT_} = 1mA$		1.207	1.25	1.288	V
SET Input Leakage Current (Note 2)	$I_{SET_}$	$V_{SET_} = 1.3V$			0.015	50	nA
THERMAL PROTECTION							
Thermal Shutdown Temperature	T_{SHDN}				170		$^{\circ}C$
Thermal Shutdown Hysteresis	ΔT_{SHDN}				20		$^{\circ}C$

Note 1: Guaranteed by line regulation test.

Note 2: Adjustable mode only.

Note 3: Not tested. For design purposes, the current limit should be considered 120mA minimum to 320mA maximum.

Note 4: The dropout voltage is defined as ($V_{IN_} - V_{OUT_}$) when $V_{OUT_}$ is 100mV below the value of $V_{OUT_}$ for $V_{IN_} = V_{OUT_} + 2V$.

Note 5: Specifications to $-40^{\circ}C$ are guaranteed by design and not production tested.

Dual, Low-Dropout, 100mA Linear Regulators

Typical Operating Characteristics

($V_{IN} = +3.6V$, $C_{IN} = 2\mu F$, $C_{OUT} = 1\mu F$, $SHDN2 = GND$, MAX886_S, $T_A = +25^\circ C$, unless otherwise noted.)

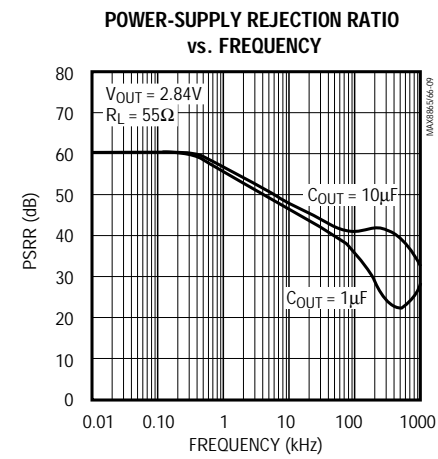
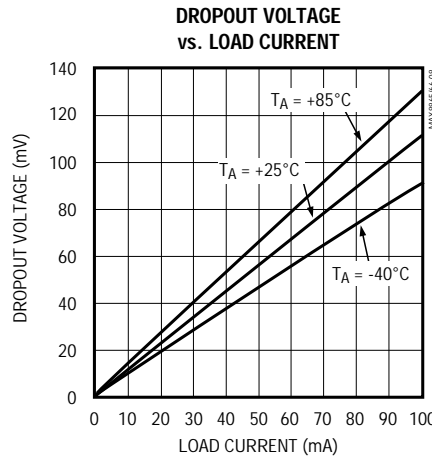
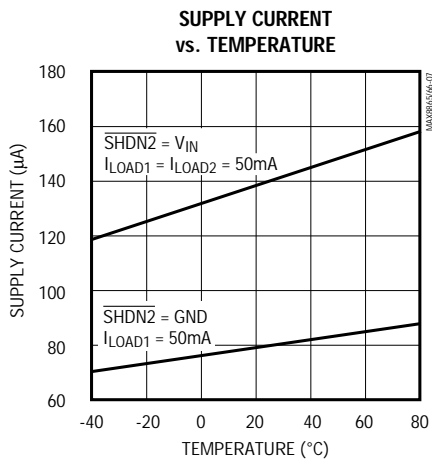
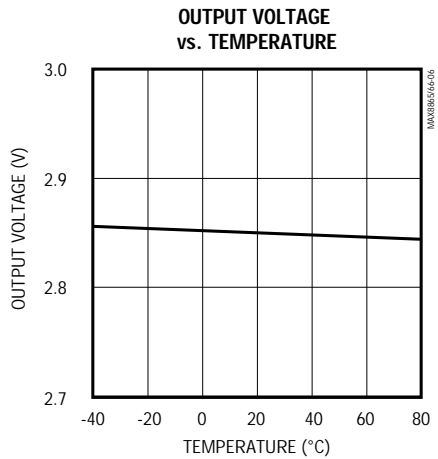
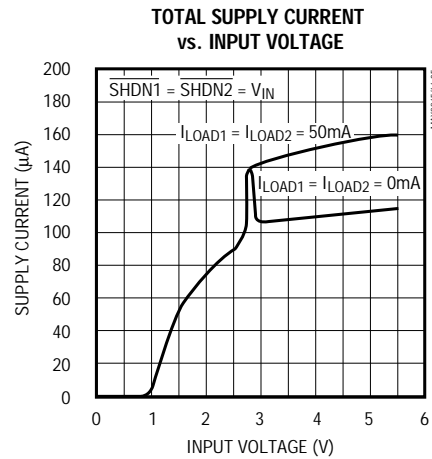
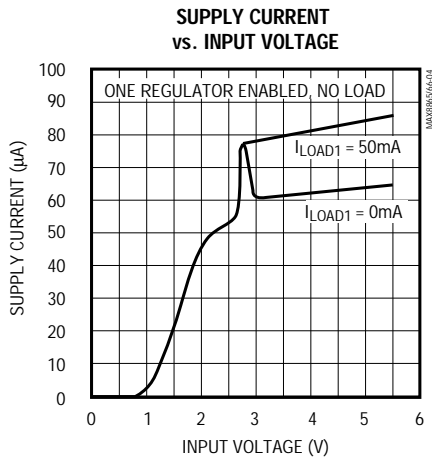
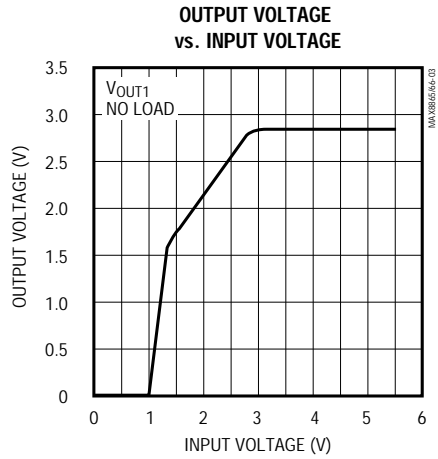
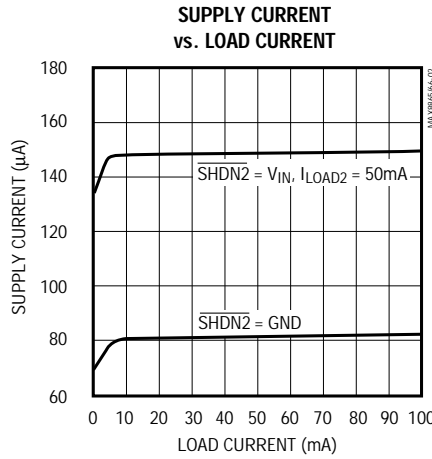
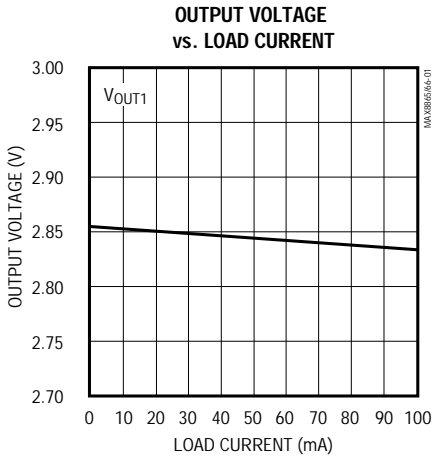

Dual, Low-Dropout, 100mA Linear Regulators

Typical Operating Characteristics (continued)

($V_{IN} = +3.6V$, $C_{IN} = 2\mu F$, $C_{OUT} = 1\mu F$, $\overline{SHDN2} = GND$, MAX886_S, $T_A = +25^\circ C$, unless otherwise noted.)

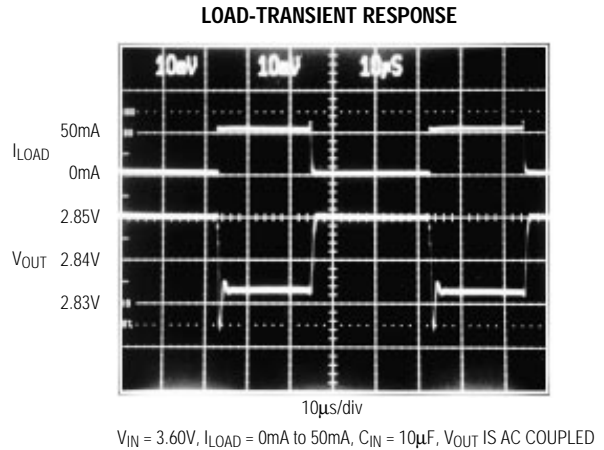
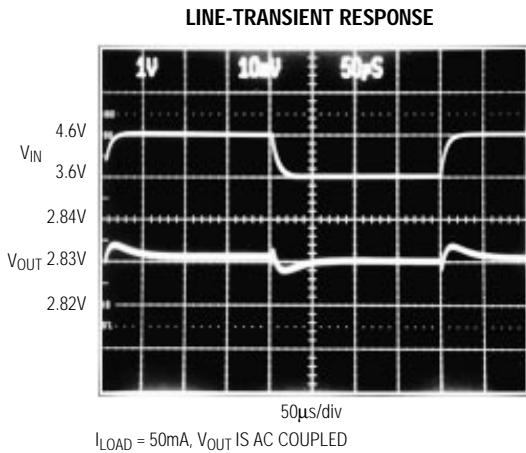
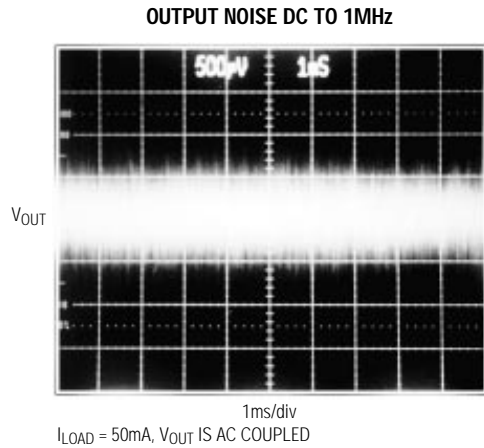
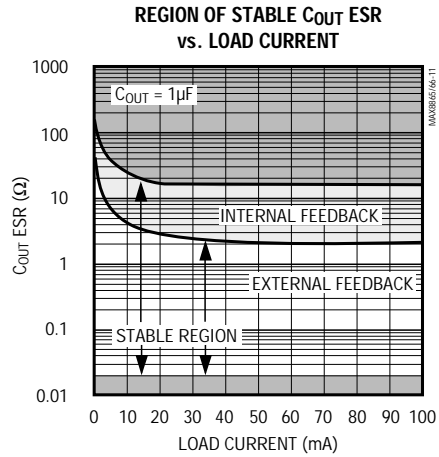
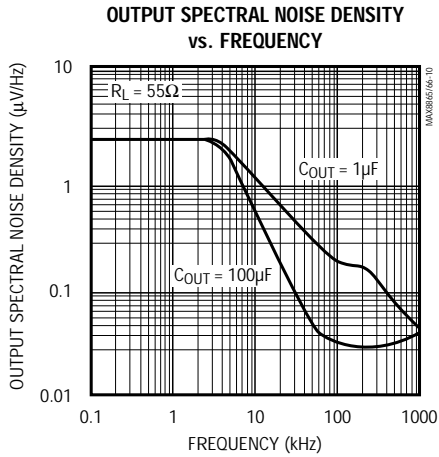

MAX8865T/S/R, MAX8866T/S/R

Dual, Low-Dropout, 100mA Linear Regulators

Typical Operating Characteristics (continued)

($V_{IN} = +3.6V$, $C_{IN} = 2\mu F$, $C_{OUT} = 1\mu F$, $SHDN2 = GND$, MAX886_S, $T_A = +25^\circ C$, unless otherwise noted.)

LOAD-TRANSIENT RESPONSE

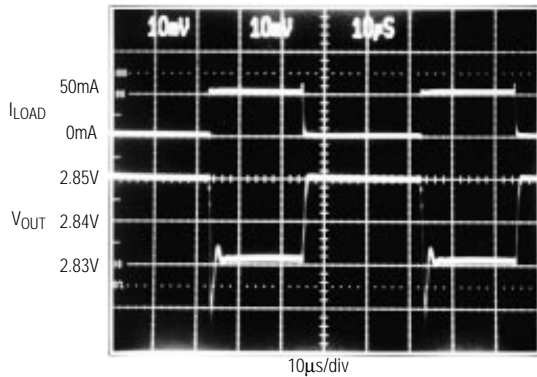

$V_{IN} = V_{OUT} + 0.2V$, $I_{LOAD} = 0mA$ to $50mA$, $C_{IN} = 10\mu F$, V_{OUT} IS AC COUPLED

LOAD-TRANSIENT RESPONSE

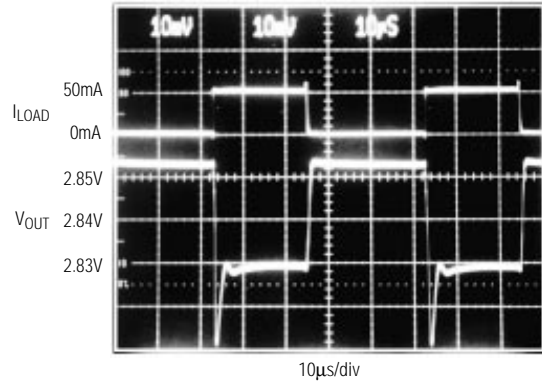

$V_{IN} = V_{OUT} + 0.1V$, $I_{LOAD} = 0mA$ to $50mA$, $C_{IN} = 10\mu F$, V_{OUT} IS AC COUPLED

CROSTALK DUE TO LOAD TRANSIENT

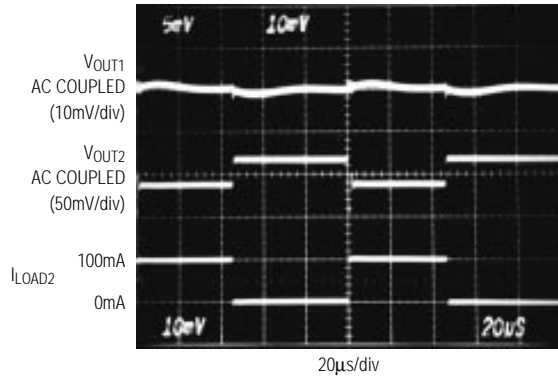

$C_{IN} = 10\mu F$, $I_{OUT1} = 100mA$, $SHDN2 = V_{IN}$

MAX8866 SHUTDOWN (NO LOAD)

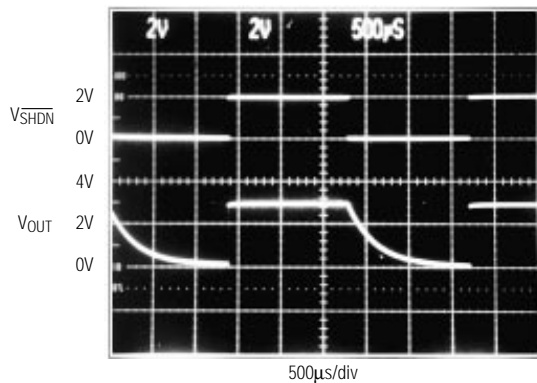

NO LOAD

MAX8866 SHUTDOWN (50mA LOAD)

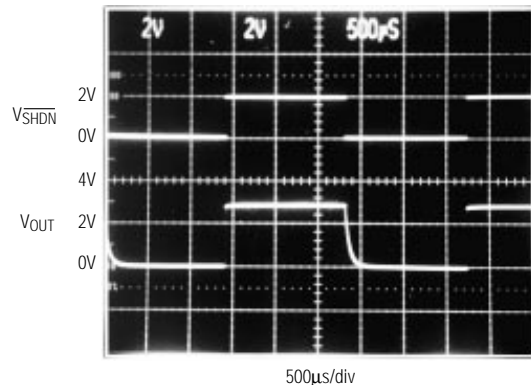

$I_{LOAD} = 50mA$

Dual, Low-Dropout, 100mA Linear Regulators

Pin Description

PIN	NAME	FUNCTION
1	OUT1	Regulator 1 Output. Fixed or adjustable from 1.25V to 5.5V. Sources up to 100mA. Bypass with a 1 μ F capacitor to GND.
2	IN	Regulator Input. Supply voltage can range from +2.5V to +5.5V. Bypass with 2 μ F to GND.
3	GND	Ground. Solder to large pads or the circuit board ground plane to maximize thermal dissipation.
4	OUT2	Regulator 2 Output. Fixed or adjustable from 1.25V to 5.5V. Sources up to 100mA. Bypass with a 1 μ F capacitor to GND.
5	SET2	Feedback Input for Setting the Output 2 Voltage. Connect to GND to set the output voltage to the preset 2.80V (MAX886_R), 2.84V (MAX886_S), or 3.15V (MAX886_T). Connect to an external resistor divider for adjustable-output operation.
6	$\overline{\text{SHDN2}}$	Active-Low Shutdown 2 Input. A logic low turns off regulator 2. On the MAX8866, a logic low also causes the output voltage to discharge to GND. Connect to IN for normal operation.
7	$\overline{\text{SHDN1}}$	Active-Low Shutdown 1 Input. A logic low turns off regulator 1. On the MAX8866, a logic low also causes the output voltage to discharge to GND. Connect to IN for normal operation.
8	SET1	Feedback Input for Setting the Output 1 Voltage. Connect to GND to set the output voltage to the preset 2.80V (MAX886_R), 2.84V (MAX886_S), or 3.15V (MAX886_T). Connect to an external resistor divider for adjustable-output operation.

Detailed Description

The MAX8865/MAX8866 are dual, low-dropout, low-quiescent-current linear regulators designed primarily for battery-powered applications. They supply adjustable 1.25V to 5.5V outputs or preselected 2.80V (MAX886_R), 2.84V (MAX886_S), or 3.15V (MAX886_T) outputs for load currents up to 100mA. As illustrated in Figure 1, these devices have a 1.25V reference and two independent linear regulators. Each linear regulator consists of an error amplifier, MOSFET driver, P-channel pass transistor, Dual Mode™ comparator, and internal feedback voltage divider.

The 1.25V bandgap reference is connected to the error amplifiers' inverting inputs. Each error amplifier compares this reference with the selected feedback voltage and amplifies the difference. The MOSFET driver reads the error signal and applies the appropriate drive to the P-channel pass transistor. If the feedback voltage is lower than the reference, the pass-transistor gate is pulled lower, allowing more current to pass and increasing the output voltage. If the feedback voltage is too high, the pass-transistor gate is pulled up, allowing less current to pass to the output.

The output voltage is fed back through either an internal resistor voltage divider connected to the OUT_ pin, or an external resistor network connected to the SET_ pin. The Dual Mode comparator examines the SET_

voltage and selects the feedback path. If SET_ is below 60mV, internal feedback is used and the output voltage is regulated to 2.80V for the MAX886_R, 2.84V for the MAX886_S, or 3.15V for the MAX886_T. Both regulators are preset for the same voltage. The reference and the thermal sensor are shared between the regulators. Duplicate blocks exist for current limiters, reverse battery protection, and shutdown logic.

Internal P-Channel Pass Transistor

The MAX8865/MAX8866 feature 1.1 Ω typical P-channel MOSFET pass transistors. This provides several advantages over similar designs using PNP pass transistors, including longer battery life.

The P-channel MOSFET requires no base-drive current, which reduces quiescent current significantly. PNP-based regulators waste considerable amounts of current in dropout when the pass transistor saturates. They also use high base-drive currents under large loads. The MAX8865/MAX8866 do not suffer from these problems, and consume only 145 μ A of quiescent current, whether in dropout, light load, or heavy load applications (see *Typical Operating Characteristics*).

Output Voltage Selection

The MAX8865/MAX8866 feature Dual Mode operation: they operate in either a preset voltage mode or an adjustable mode.

Dual, Low-Dropout, 100mA Linear Regulators

MAX8865T/S/R, MAX8866T/S/R

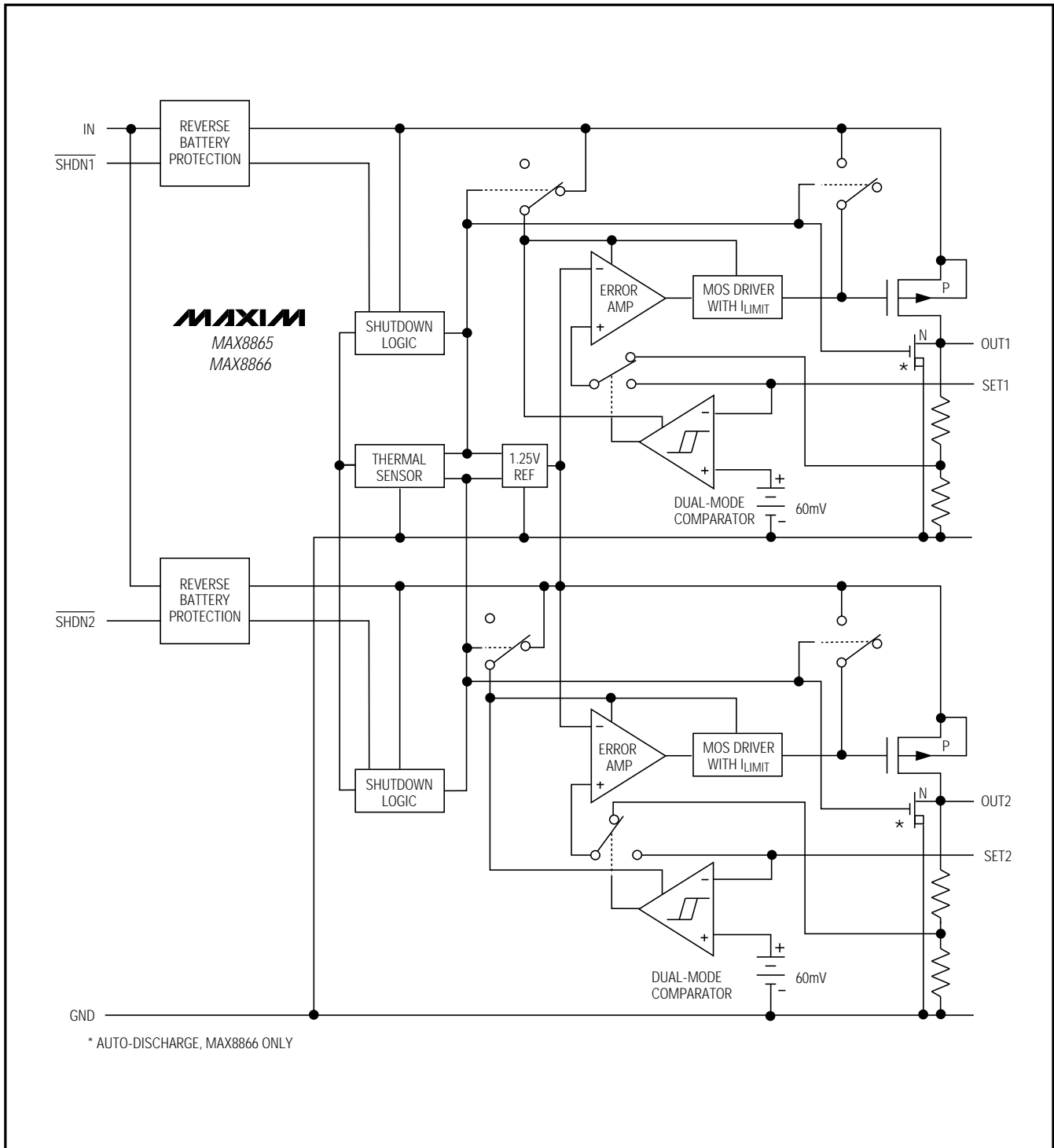

Figure 1. Functional Diagram

Dual, Low-Dropout, 100mA Linear Regulators

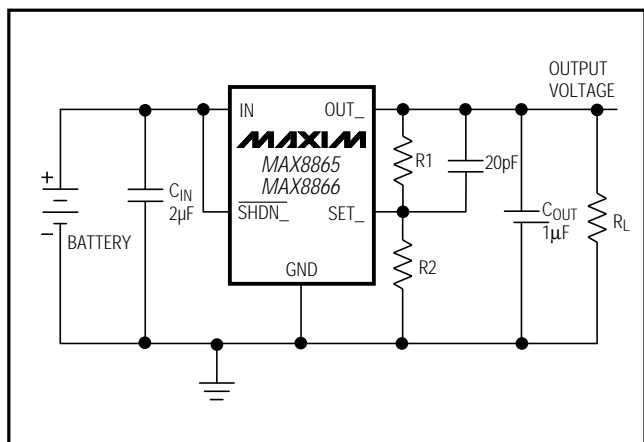

Figure 2. Adjustable Output Using External Feedback Resistors

In preset voltage mode, internal, trimmed feedback resistors set the MAX886_R outputs to 2.80V, the MAX886_S outputs to 2.84V, and the MAX886_T outputs to 3.15V. Select this mode by connecting SET_ to ground. If SET_ can't be grounded in preset voltage mode, limit impedances between SET_ and ground to less than 100kΩ. Otherwise, spurious conditions could cause the voltage at SET_ to exceed the 60mV Dual Mode threshold.

In adjustable mode, select an output between 1.25V and 5.5V using two external resistors connected as a voltage divider to SET_ (Figure 2). The output voltage is set by the following equation:

$$V_{OUT_} = V_{SET_} (1 + R1 / R2)$$

where $V_{SET_} = 1.25V$. To simplify resistor selection:

$$R1 = R2 \left(\frac{V_{OUT_}}{V_{SET_}} - 1 \right)$$

Choose $R2 = 100k\Omega$ to optimize power consumption, accuracy, and high-frequency power-supply rejection. The total current through the external resistive feedback and load resistors should not be less than 10µA. Since the $V_{SET_}$ tolerance is typically less than ±25mV, the output can be set using fixed resistors instead of trim pots. Connect a 10pF to 25pF capacitor across R1 to compensate for layout-induced parasitic capacitances.

Shutdown

A low input on a $\overline{SHDN_}$ pin individually shuts down one of the two outputs. In shutdown mode, the selected pass transistor, control circuit, and all biases are turned

off. When both sections are turned off, the reference and thermal shutdown are also turned off and the supply current is typically reduced to 0.16nA. Connect $\overline{SHDN_}$ to IN for normal operation. The MAX8866 output voltages are actively discharged to ground when individual regulators are shut down (see *Typical Operating Characteristics*).

Current Limit

The MAX8865/MAX8866 include a current limiter for each output section that monitors and controls the pass transistor's gate voltage, estimating the output current and limiting it to about 220mA. For design purposes, the current limit should be considered 120mA (min) to 320mA (max). The outputs can be shorted to ground for an indefinite time period without damaging the part.

Thermal Overload Protection

Thermal overload protection limits total power dissipation in the MAX8865/MAX8866. When the junction temperature exceeds $T_J = +170^\circ C$, the thermal sensor sends a signal to the shutdown logic, turning off the pass transistors and allowing the IC to cool. The thermal sensor will turn the pass transistors on again after the IC's junction temperature typically cools by 20°C, resulting in a pulsed output during continuous thermal overload conditions.

Thermal overload protection is designed to protect the MAX8865/MAX8866 in the event of fault conditions. Stressing the device with high load currents and high input-output differential voltages (which result in elevated die temperatures above +125°C) may cause a momentary overshoot (2% to 8% for 200ms) when the load is completely removed. This can be remedied by raising the minimum load current from 0µA (+125°C) to 100µA (+150°C). For continuous operation, do not exceed the absolute maximum junction temperature rating of $T_J = +150^\circ C$.

Operating Region and Power Dissipation

Maximum power dissipation of the MAX8865/MAX8866 depends on the thermal resistance of the case and circuit board, the temperature difference between the die junction and ambient air, and the rate of air flow. The power dissipation across the device is $P = I_{OUT} (V_{IN} - V_{OUT})$. The resulting maximum power dissipation is:

$$P_{MAX} = (T_J - T_A) / \theta_{JA}$$

where $(T_J - T_A)$ is the temperature difference between the MAX8865/MAX8866 die junction and the surrounding air, and θ_{JA} is the thermal resistance of the package to the surrounding air (244°C/W).

Dual, Low-Dropout, 100mA Linear Regulators

Reverse Battery Protection

The MAX8865/MAX8866 have a unique protection scheme that limits the reverse supply current to less than 1mA when either V_{IN} or V_{SHDN} falls below ground. The circuitry monitors the polarity of these pins, disconnecting the internal circuitry and parasitic diodes when the battery is reversed. This feature prevents the device from overheating and damaging the battery.

Applications Information

Capacitor Selection and Regulator Stability

Normally, use two $1\mu\text{F}$ surface-mount ceramic capacitors on the input and a $1\mu\text{F}$ surface-mount ceramic capacitor on each output of the MAX8865/MAX8866. Larger input capacitor values and lower ESR provide better supply-noise rejection and transient response. A higher-value input capacitor ($10\mu\text{F}$) may be necessary if large, fast transients are anticipated and the device is located several inches from the power source. Improve load-transient response, stability, and power-supply rejection by using large output capacitors. For stable operation over the full temperature range, with load currents of 100mA, a minimum of $1\mu\text{F}$ is recommended (see the Region of Stable C_{OUT} ESR vs. Load Current graph in the *Typical Operating Characteristics*).

Noise

The MAX8865/MAX8866 exhibit $350\mu\text{VRMS}$ noise during normal operation. When using the MAX8865/MAX8866 in applications that include analog-to-digital converters of greater than 12 bits, consider the ADC's power-supply rejection specifications (see the Output Noise DC to 1MHz photo in the *Typical Operating Characteristics*).

Power-Supply Rejection and Operation from Sources Other than Batteries

The MAX8865/MAX8866 are designed to deliver low dropout voltages and low quiescent currents in battery-powered systems. Power-supply rejection is 60dB at low frequencies and rolls off above 400Hz. As the frequency increases above 100kHz, the output capacitor is the major contributor to the rejection of power-supply noise

(see the Power-Supply Rejection Ratio vs. Frequency graph in the *Typical Operating Characteristics*).

When operating from sources other than batteries, improve supply-noise rejection and transient response by increasing the values of the input and output capacitors, and using passive filtering techniques (see the supply and load-transient responses in the *Typical Operating Characteristics*).

Load-Transient Considerations

The MAX8865/MAX8866 load-transient response graphs (see *Typical Operating Characteristics*) show two components of the output response: a DC shift of the output voltage due to the different load currents, and the transient response. Typical overshoot for step changes in the load current from 0mA to 50mA is 12mV. Increasing the output capacitor's value and decreasing its ESR attenuates transient spikes.

Cross-Regulation

Cross-regulation refers to the change in one output voltage when the load changes on the other output. For the MAX8865/MAX8866, cross-regulation for a 0mA to 50mA load change on one side results in less than 1mV change of output voltage. If the power dissipation on one output causes the junction temperature to exceed 125°C , ensure regulation of the other output with a minimum load current of $100\mu\text{A}$.

Input-Output (Dropout) Voltage

A regulator's minimum input-output voltage differential (or dropout voltage) determines the lowest usable supply voltage. In battery-powered systems, this will determine the useful end-of-life battery voltage. Because the MAX8865/MAX8866 use P-channel MOSFET pass transistors, their dropout voltages are a function of $R_{DS(ON)}$ multiplied by the load currents (see *Electrical Characteristics*).

Chip Information

TRANSISTOR COUNT: 259

Dual, Low-Dropout, 100mA Linear Regulators

Package Information

MAX8865T/S/R, MAX8866T/S/R

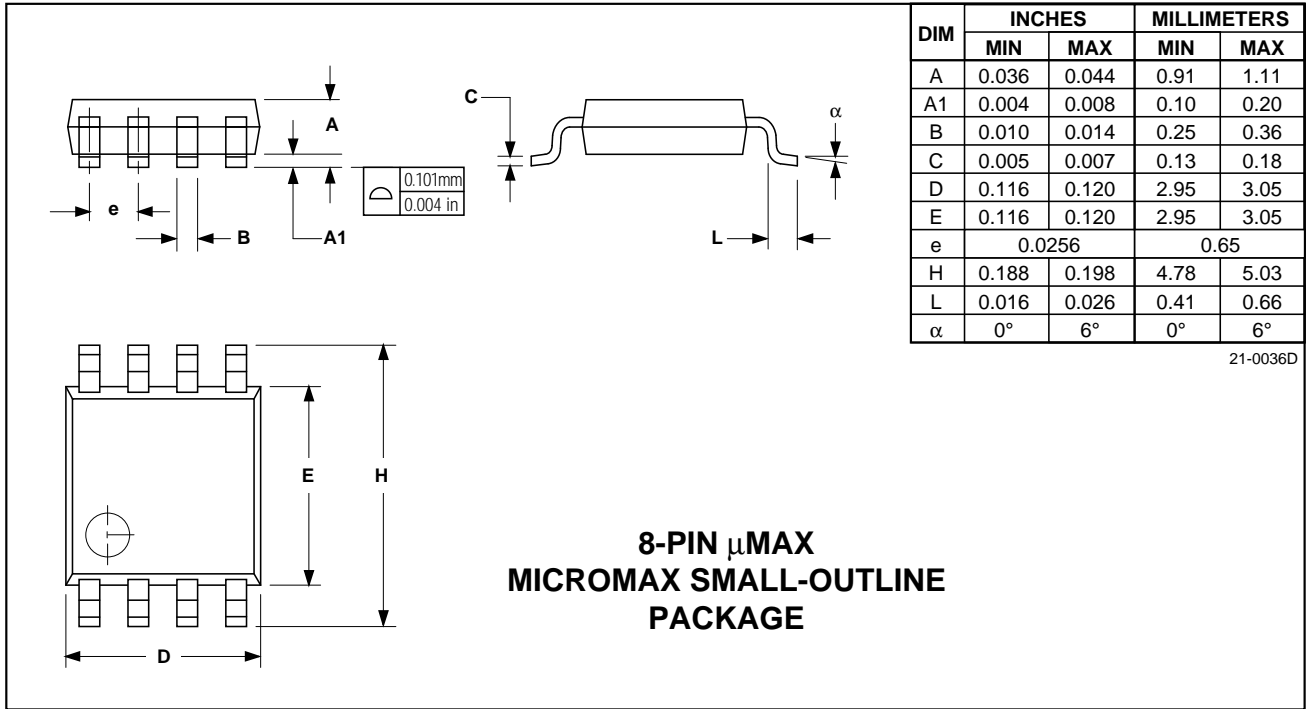

Dual, Low-Dropout, 100mA Linear Regulators

MAX8865T/S/R, MAX8866T/S/R

Maxim cannot assume responsibility for use of any circuitry other than circuitry entirely embodied in a Maxim product. No circuit patent licenses are implied. Maxim reserves the right to change the circuitry and specifications without notice at any time.

12 _____ Maxim Integrated Products, 120 San Gabriel Drive, Sunnyvale, CA 94086 (408) 737-7600

© 1996 Maxim Integrated Products

Printed USA

MAXIM is a registered trademark of Maxim Integrated Products.

Mouser Electronics

Authorized Distributor

Click to View Pricing, Inventory, Delivery & Lifecycle Information:

Maxim Integrated:

[MAX8865TEUA+](#) [MAX8865TEUA+T](#) [MAX8866TEUA+](#) [MAX8866TEUA+T](#) [MAX8866TEUA](#) [MAX8866TEUA-T](#)
[MAX8865REUA+](#) [MAX8866REUA+T](#) [MAX8866SEUA+](#) [MAX8866SEUA+T](#) [MAX8865REUA](#) [MAX8865REUA-T](#)
[MAX8865TEUA](#) [MAX8865TEUA-T](#) [MAX8866REUA](#) [MAX8866SEUA-T](#) [MAX8865SEUA](#) [MAX8865REUA+T](#)
[MAX8866REUA+](#) [MAX8865SEUA-T](#) [MAX8866REUA-T](#) [MAX8866SEUA](#)