

Features

- Temperature ranges
 - Industrial: -40 °C to 85 °C
 - Automotive-A: -40 °C to 85 °C
- Pin-and function-compatible with CY7C1021CV33
- High speed
 - $t_{AA} = 10 \text{ ns}$
- Low active power
 - $I_{CC} = 60 \text{ mA @ } 10 \text{ ns}$
- Low CMOS standby power
 - $I_{SB2} = 3 \text{ mA}$
- 2.0 V data retention
- Automatic power-down when deselected
- CMOS for optimum speed/power
- Independent control of upper and lower bits
- Available in Pb-free 44-pin 400-Mil wide molded SOJ, 44-pin TSOP II and 48-ball VFBGA packages

Functional Description

The CY7C1021DV33 is a high-performance CMOS static RAM organized as 65,536 words by 16 bits. This device has an automatic power-down feature that significantly reduces power consumption when deselected.

Writing to the device is accomplished by taking Chip Enable (\overline{CE}) and Write Enable (WE) inputs LOW. If Byte Low Enable (BLE) is LOW, then data from I/O pins (I/O₀ through I/O₇), is written into the location specified on the address pins (A₀ through A₁₅). If Byte High Enable (BHE) is LOW, then data from I/O pins (I/O₈ through I/O₁₅) is written into the location specified on the address pins (A₀ through A₁₅).

Reading from the device is accomplished by taking Chip Enable (\overline{CE}) and Output Enable (\overline{OE}) LOW while forcing the Write Enable (WE) HIGH. If Byte Low Enable (BLE) is LOW, then data from the memory location specified by the address pins will appear on I/O₀ to I/O₇. If Byte High Enable (BHE) is LOW, then data from memory will appear on I/O₈ to I/O₁₅. See the truth table at the end of this data sheet for a complete description of Read and Write modes.

The input/output pins (I/O₀ through I/O₁₅) are placed in a high-impedance state when the device is deselected (\overline{CE} HIGH), the outputs are disabled (\overline{OE} HIGH), the BHE and BLE are disabled (BHE, BLE HIGH), or during a Write operation (\overline{CE} LOW, and WE LOW).

The CY7C1021DV33 is available in Pb-free 44-pin 400-Mil wide Molded SOJ, 44-pin TSOP II and 48-ball VFBGA packages.

For a complete list of related resources, [click here](#).

Logic Block Diagram

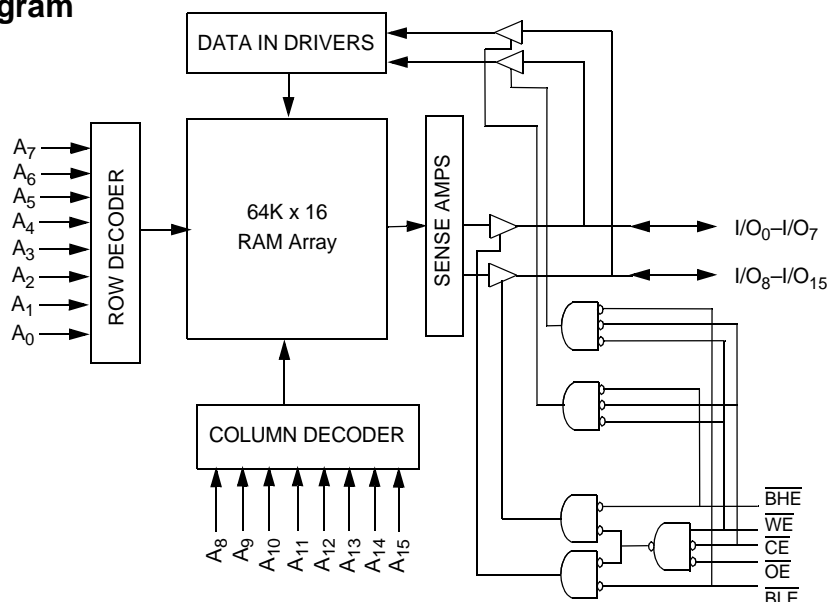

Contents

Selection Guide	3	Ordering Information	12
Pin Configurations	3	Ordering Code Definitions	12
Maximum Ratings	4	Package Diagrams	13
Operating Range	4	Acronyms	15
Electrical Characteristics	4	Document Conventions	15
DC Electrical Characteristics	4	Units of Measure	15
Capacitance	5	Document History Page	16
Thermal Resistance	5	Sales, Solutions, and Legal Information	18
AC Test Loads and Waveforms	5	Worldwide Sales and Design Support	18
Data Retention Characteristics	6	Products	18
Data Retention Waveform	6	PSoC® Solutions	18
Switching Characteristics	7	Cypress Developer Community	18
Switching Waveforms	8	Technical Support	18
Truth Table	11		

Selection Guide

Description	-10 (Industrial / Automotive-A)	Unit
Maximum access time	10	ns
Maximum operating current	60	mA
Maximum CMOS standby current	3	mA

Pin Configurations

SOJ, TSOP II and VFBGA pinouts are as follows. [1]

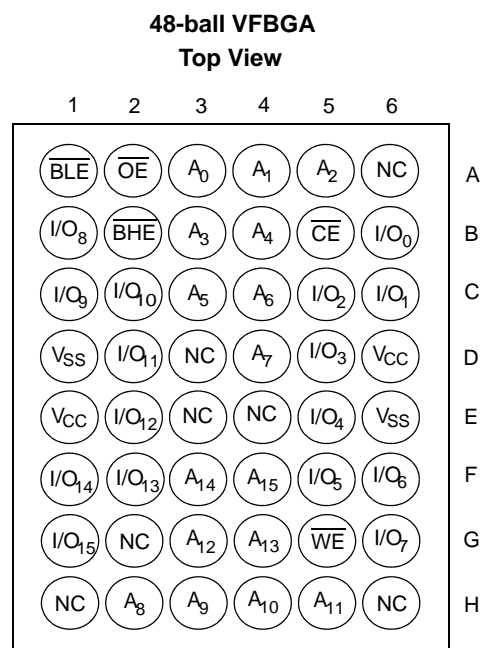
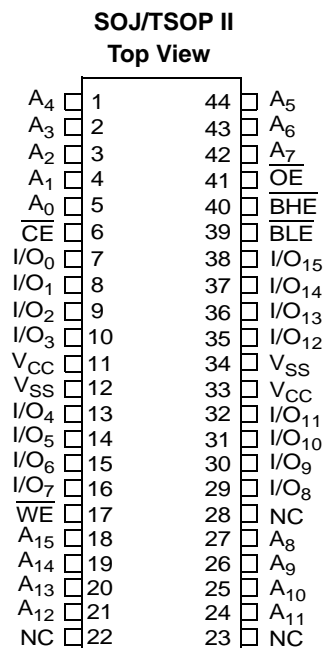

Note

1. NC pins are not connected on the die.

Maximum Ratings

Exceeding maximum ratings may impair the useful life of the device. These user guidelines are not tested.

Storage temperature	-65 °C to +150 °C
Ambient temperature with power applied	-55 °C to +125 °C
Supply voltage on V _{CC} to Relative GND [2]	-0.3 V to +4.6 V
DC Voltage applied to outputs in high Z State [2]	-0.3 V to V _{CC} + 0.3 V
DC input voltage [2]	-0.3 V to V _{CC} + 0.3 V

Current into outputs (LOW)	20 mA
Static discharge voltage (per MIL-STD-883, method 3015)	> 2001 V
Latch-up current	> 200 mA

Operating Range

Range	Ambient Temperature	V _{CC}	Speed
Industrial	-40 °C to +85 °C	3.3 V ± 0.3 V	10 ns
Automotive-A	-40 °C to +85 °C		10 ns

Electrical Characteristics

Over the Operating Range

DC Electrical Characteristics

Over the Operating Range

Parameter	Description	Test Conditions	-10 (Industrial / Automotive-A)		Unit	
			Min	Max		
V _{OH}	Output HIGH voltage	V _{CC} = Min, I _{OH} = -4.0 mA	2.4	-	V	
V _{OL}	Output LOW voltage	V _{CC} = Min, I _{OL} = 8.0 mA	-	0.4	V	
V _{IH}	Input HIGH voltage		2.0	V _{CC} + 0.3	V	
V _{IL}	Input LOW voltage [2]		-0.3	0.8	V	
I _{Ix}	Input leakage current	GND ≤ V _I ≤ V _{CC}	-1	+1	μA	
I _{Oz}	Output leakage current	GND ≤ V _I ≤ V _{CC} , Output Disabled	-1	+1	μA	
I _{CC}	V _{CC} operating supply current	V _{CC} = Max, I _{OUT} = 0 mA, f = f _{MAX} = 1/t _{RC}	100 MHz	-	60	mA
			83 MHz	-	55	mA
			66 MHz	-	45	mA
			40 MHz	-	30	mA
I _{SB1}	Automatic CE Power-Down Current – TTL Inputs	Max V _{CC} , $\overline{CE} \geq V_{IH}$, V _{IN} ≥ V _{IH} or V _{IN} ≤ V _{IL} , f = f _{MAX}	-	10	mA	
I _{SB2}	Automatic CE Power-Down Current – CMOS Inputs	Max V _{CC} , $\overline{CE} \geq V_{CC} - 0.3 V$, V _{IN} ≥ V _{CC} - 0.3 V or V _{IN} ≤ 0.3 V, f = 0	-	3	mA	

Note

2. V_{IL(min)} = -2.0 V and V_{IH(max)} = V_{CC} + 1 V for pulse durations of less than 5 ns.

Capacitance

Parameter ^[3]	Description	Test Conditions	Max	Unit
C _{IN}	Input capacitance	T _A = 25 °C, f = 1 MHz, V _{CC} = 3.3 V	8	pF
C _{OUT}	Output capacitance		8	pF

Thermal Resistance

Parameter ^[3]	Description	Test Conditions	SOJ	TSOP II	VFBGA	Unit
Θ _{JA}	Thermal resistance (junction to ambient)	Still Air, soldered on a 3 x 4.5 inch, four-layer printed circuit board	59.52	53.91	36	°C/W
Θ _{JC}	Thermal resistance (junction to case)		36.75	21.24	9	°C/W

AC Test Loads and Waveforms

Figure 1. AC Test Loads and Waveforms ^[4]

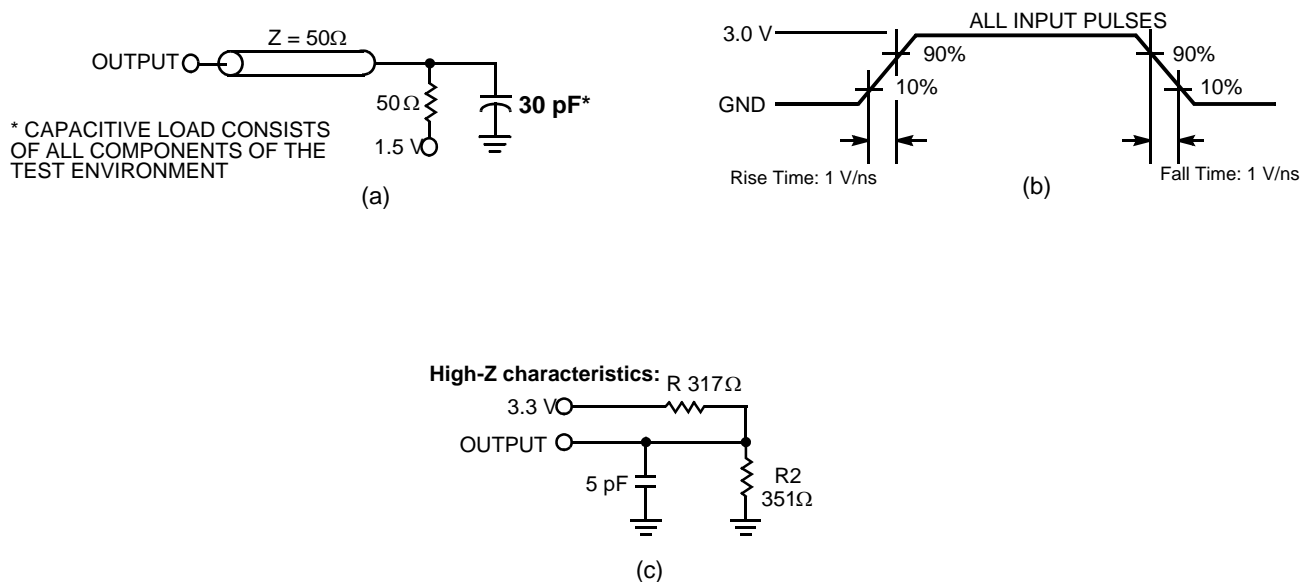

Notes

- 3. Tested initially and after any design or process changes that may affect these parameters.
- 4. AC characteristics (except High Z) are tested using the load conditions shown in Figure 1 (a). High Z characteristics are tested for all speeds using the test load shown in Figure 1 (c).

Data Retention Characteristics

Over the Operating Range

Parameter	Description	Conditions	Min	Max	Unit
V_{DR}	V_{CC} for data retention		2	–	V
I_{CCDR}	Data retention current	$V_{CC} = V_{DR} = 2.0\text{ V}$, $\overline{CE} \geq V_{CC} - 0.3\text{ V}$, $V_{IN} \geq V_{CC} - 0.3\text{ V}$ or $V_{IN} \leq 0.3\text{ V}$	–	3	mA
$t_{CDR}^{[5]}$	Chip deselect to data retention time		0	–	ns
$t_R^{[6]}$	Operation recovery time		t_{RC}	–	ns

Data Retention Waveform

Figure 2. Data Retention Waveform

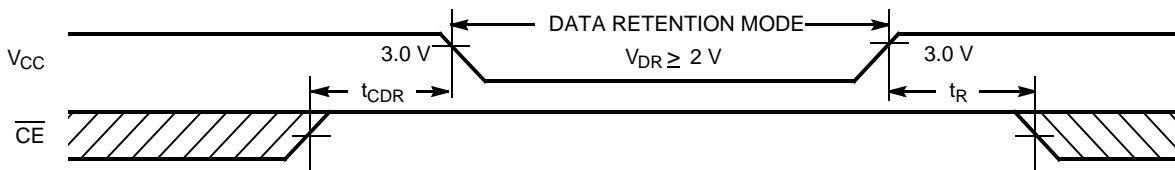

Notes

5. Tested initially and after any design or process changes that may affect these parameters.
6. Full device operation requires linear V_{CC} ramp from V_{DR} to $V_{CC(min)}$ $\geq 50\ \mu\text{s}$ or stable at $V_{CC(min)}$ $\geq 50\ \mu\text{s}$.

Switching Characteristics

Over the Operating Range

Parameter ^[7]	Description	-10 (Industrial / Automotive-A)		Unit
		Min	Max	
Read Cycle				
$t_{power}^{[8]}$	V_{CC} (typical) to the first access	100	–	μ s
t_{RC}	Read cycle time	10	–	ns
t_{AA}	Address to data valid	–	10	ns
t_{OHA}	Data hold from address change	3	–	ns
t_{ACE}	\overline{CE} LOW to data valid	–	10	ns
t_{DOE}	\overline{OE} LOW to data valid	–	5	ns
t_{LZOE}	\overline{OE} LOW to low Z ^[9]	0	–	ns
t_{HZOE}	\overline{OE} HIGH to high Z ^[9, 10]	–	5	ns
t_{LZCE}	\overline{CE} LOW to low Z ^[9]	3	–	ns
t_{HZCE}	\overline{CE} HIGH to high Z ^[9, 10]	–	5	ns
$t_{PU}^{[11]}$	\overline{CE} LOW to power-up	0	–	ns
$t_{PD}^{[11]}$	\overline{CE} HIGH to power-down	–	10	ns
t_{DBE}	Byte Enable to data valid	–	5	ns
t_{LZBE}	Byte Enable to low Z	0	–	ns
t_{HZBE}	Byte Disable to high Z	–	6	ns
Write Cycle ^[12, 13]				
t_{WC}	Write cycle time	10	–	ns
t_{SCE}	\overline{CE} LOW to write end	8	–	ns
t_{AW}	Address set-up to write end	8	–	ns
t_{HA}	Address hold from write end	0	–	ns
t_{SA}	Address set-up to write start	0	–	ns
t_{PWE}	\overline{WE} pulse width	7	–	ns
t_{SD}	Data set-up to write end	5	–	ns
t_{HD}	Data hold from write end	0	–	ns
t_{LZWE}	\overline{WE} HIGH to low Z ^[9]	3	–	ns
t_{HZWE}	\overline{WE} LOW to high Z ^[9, 10]	–	5	ns
t_{BW}	Byte enable to end of write	7	–	ns

Notes

7. Test conditions assume signal transition time of 3 ns or less, timing reference levels of 1.5 V, input pulse levels of 0 to 3.0 V.
8. t_{POWER} gives the minimum amount of time that the power supply should be at typical V_{CC} values until the first memory access can be performed.
9. At any given temperature and voltage condition, t_{HZCE} is less than t_{LZCE} , t_{HZOE} is less than t_{LZOE} , and t_{HZWE} is less than t_{LZWE} for any given device.
10. t_{HZOE} , t_{HZBE} , t_{HZCE} , and t_{HZWE} are specified with a load capacitance of 5 pF as in (c) of [Figure 1 on page 5](#). Transition is measured when the outputs enter a high impedance state.
11. This parameter is guaranteed by design and is not tested.
12. The internal Write time of the memory is defined by the overlap of \overline{CE} LOW, \overline{WE} LOW and $\overline{BHE}/\overline{BLE}$ LOW. \overline{CE} , \overline{WE} and $\overline{BHE}/\overline{BLE}$ must be LOW to initiate a Write and the transition of these signals can terminate the Write. The input data set-up and hold timing should be referenced to the leading edge of the signal that terminates the Write.
13. The minimum write pulse width for Write Cycle No. 3 (\overline{WE} Controlled, \overline{OE} LOW) should be equal to the sum of t_{SD} and t_{HZWE} .

Switching Waveforms

Figure 3. Read Cycle No. 1 (Address Transition Controlled) [14, 15]

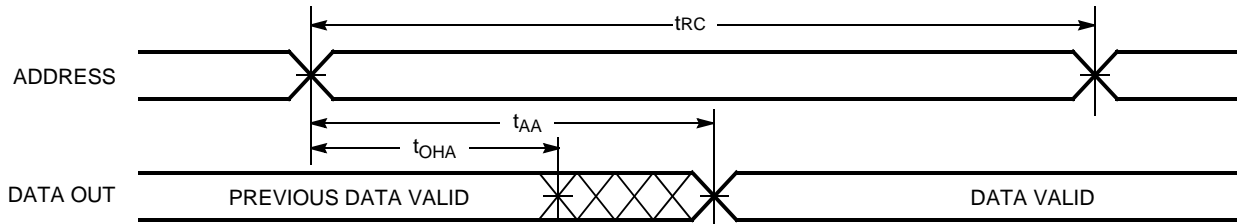
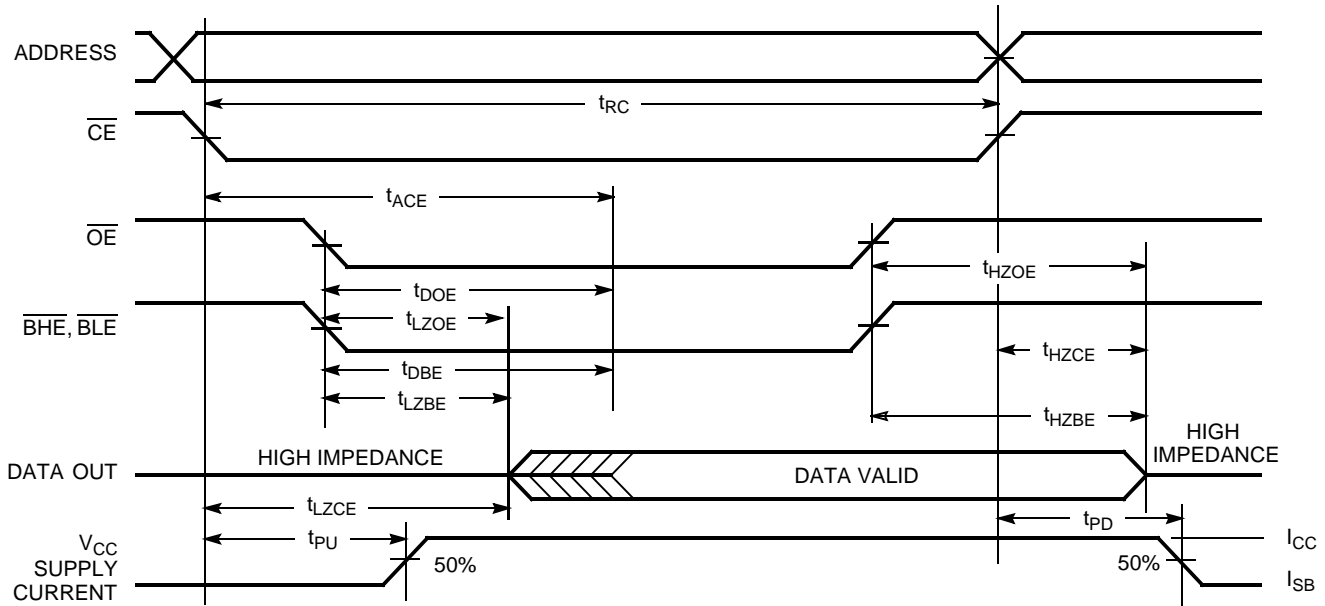

Figure 4. Read Cycle No. 2 (\overline{OE} Controlled) [15, 16]



Notes

- 14. Device is continuously selected. \overline{OE} , \overline{CE} , \overline{BHE} and/or $\overline{BLE} = V_{IL}$.
- 15. \overline{WE} is HIGH for Read cycle.
- 16. Address valid prior to or coincident with \overline{CE} transition LOW.

Switching Waveforms (continued)

Figure 5. Write Cycle No. 1 ($\overline{\text{CE}}$ Controlled) [17, 18]

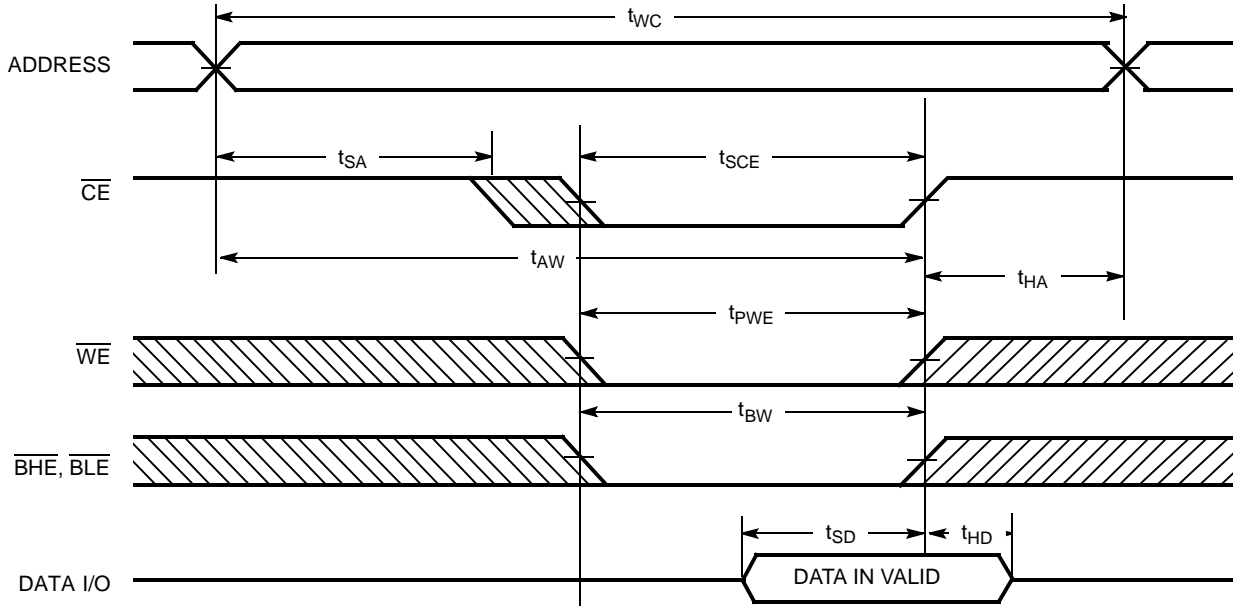
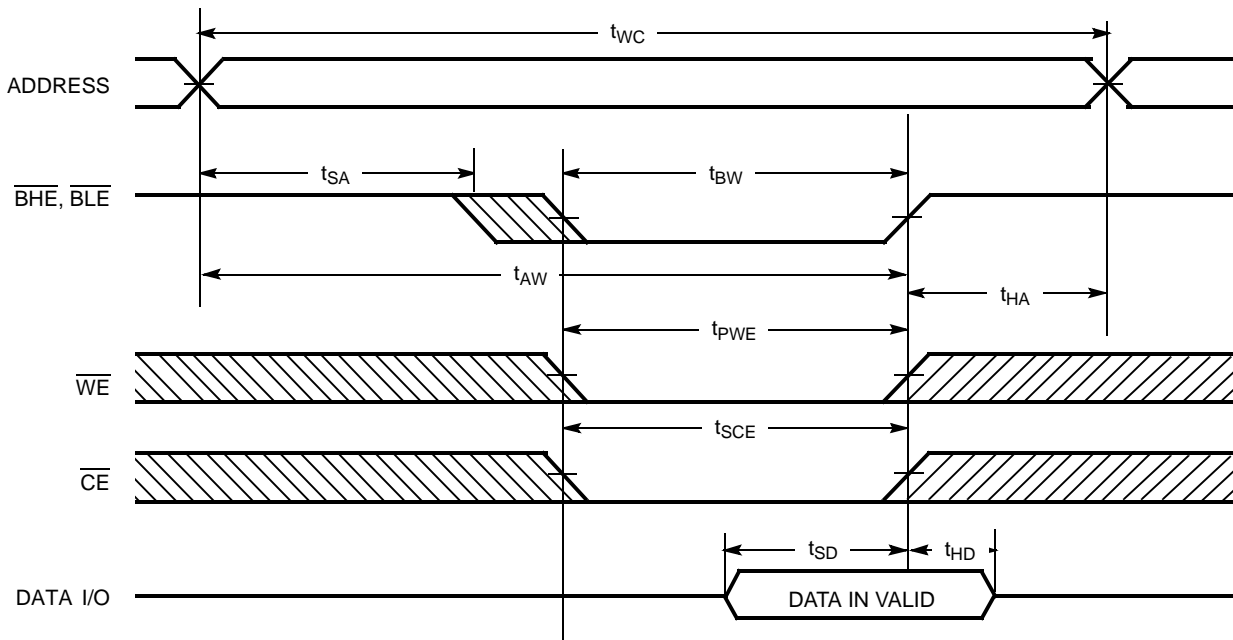

Figure 6. Write Cycle No. 2 ($\overline{\text{BLE}}$ or $\overline{\text{BHE}}$ Controlled)



Notes

- 17. Data I/O is high impedance if $\overline{\text{OE}}$ or $\overline{\text{BHE}}$ and/or $\overline{\text{BLE}} = V_{IH}$.
- 18. If $\overline{\text{CE}}$ goes HIGH simultaneously with $\overline{\text{WE}}$ going HIGH, the output remains in a high-impedance state.

Switching Waveforms (continued)

Figure 7. Write Cycle No. 3 (\overline{WE} Controlled, \overline{OE} LOW)^[19]

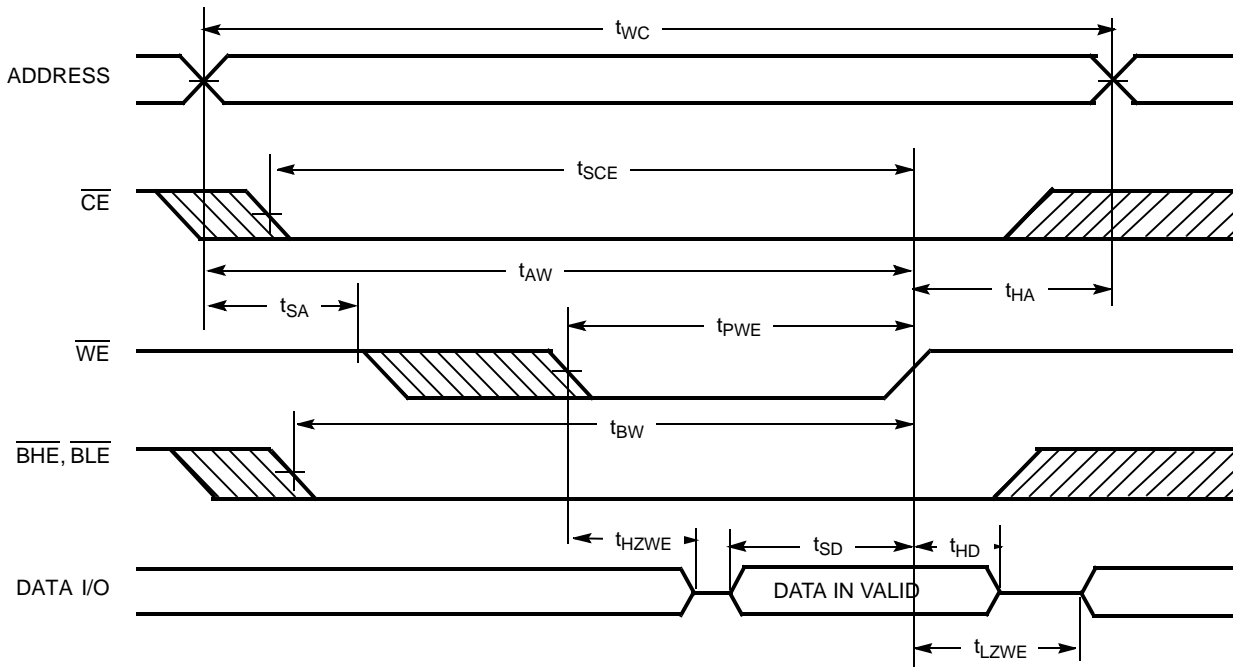

Note

19. The minimum write pulse width should be equal to the sum of t_{SD} and t_{HZWE} .

Truth Table

\overline{CE}	\overline{OE}	\overline{WE}	\overline{BLE}	\overline{BHE}	I/O ₀ -I/O ₇	I/O ₈ -I/O ₁₅	Mode	Power
H	X	X	X	X	High-Z	High-Z	Power-down	Standby (I _{SB})
L	L	H	L	L	Data Out	Data Out	Read – All bits	Active (I _{CC})
			L	H	Data Out	High-Z	Read – Lower bits only	Active (I _{CC})
			H	L	High-Z	Data Out	Read – Upper bits only	Active (I _{CC})
L	X	L	L	L	Data In	Data In	Write – All bits	Active (I _{CC})
			L	H	Data In	High-Z	Write – Lower bits only	Active (I _{CC})
			H	L	High-Z	Data In	Write – Upper bits only	Active (I _{CC})
L	H	H	X	X	High-Z	High-Z	Selected, outputs disabled	Active (I _{CC})
L	X	X	H	H	High-Z	High-Z	Selected, outputs disabled	Active (I _{CC})

Ordering Information

Speed (ns)	Ordering Code	Package Diagram	Package Type	Operating Range
10	CY7C1021DV33-10VXI	51-85082	44-pin (400-Mil) Molded SOJ (Pb-free)	Industrial
	CY7C1021DV33-10ZSXI	51-85087	44-pin TSOP Type II (Pb-free)	
	CY7C1021DV33-10BVXI	51-85150	48-ball VFBGA (Pb-free)	
10	CY7C1021DV33-10ZSXA	51-85087	44-pin TSOP Type II (Pb-free)	Automotive-A

Please contact your local Cypress sales representative for availability of these parts.

Ordering Code Definitions

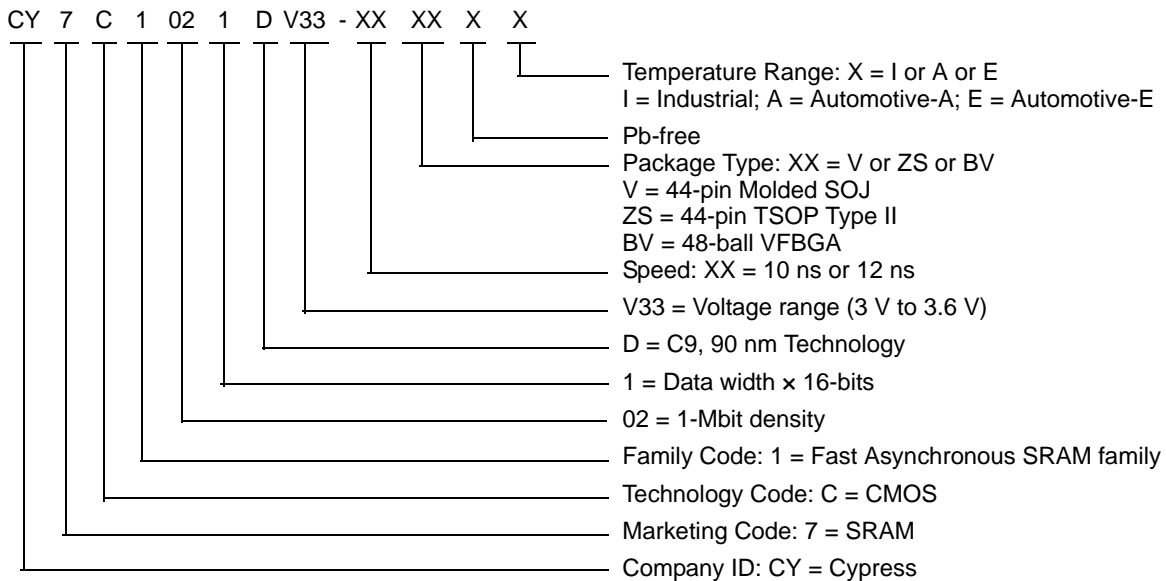

Package Diagrams

Figure 8. 44-pin SOJ (400 Mils) V44.4 Package Outline, 51-85082

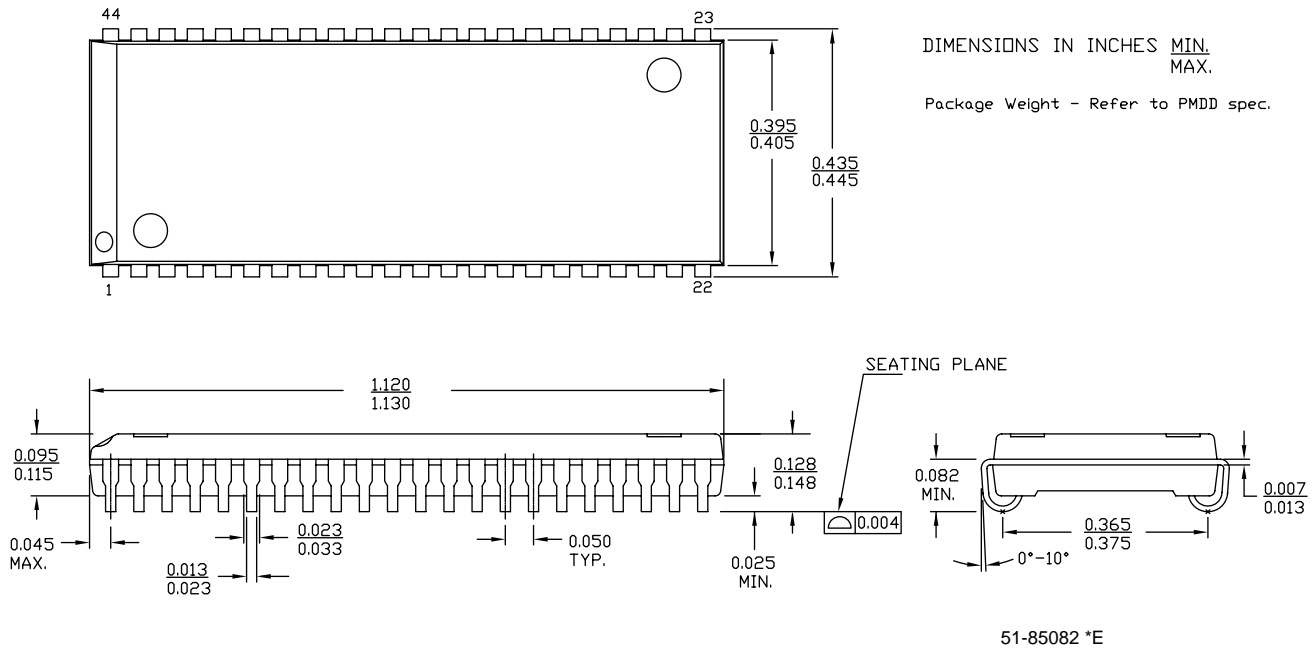
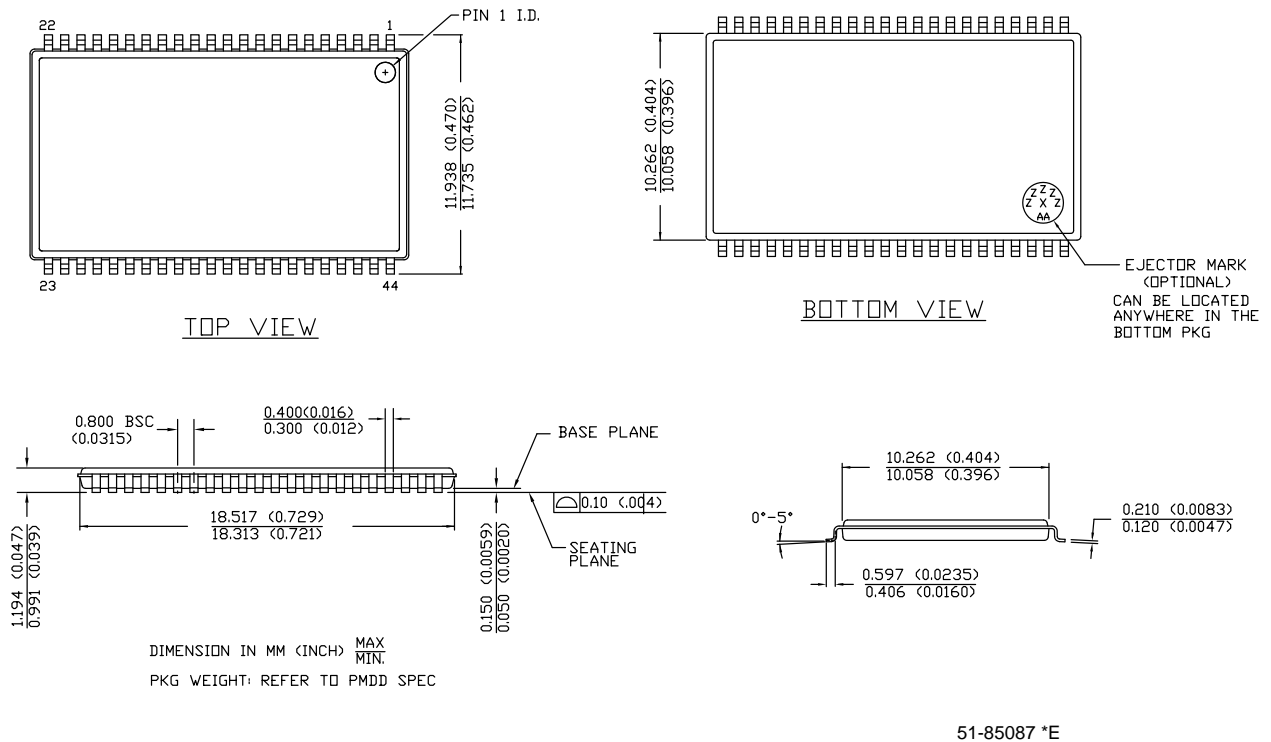
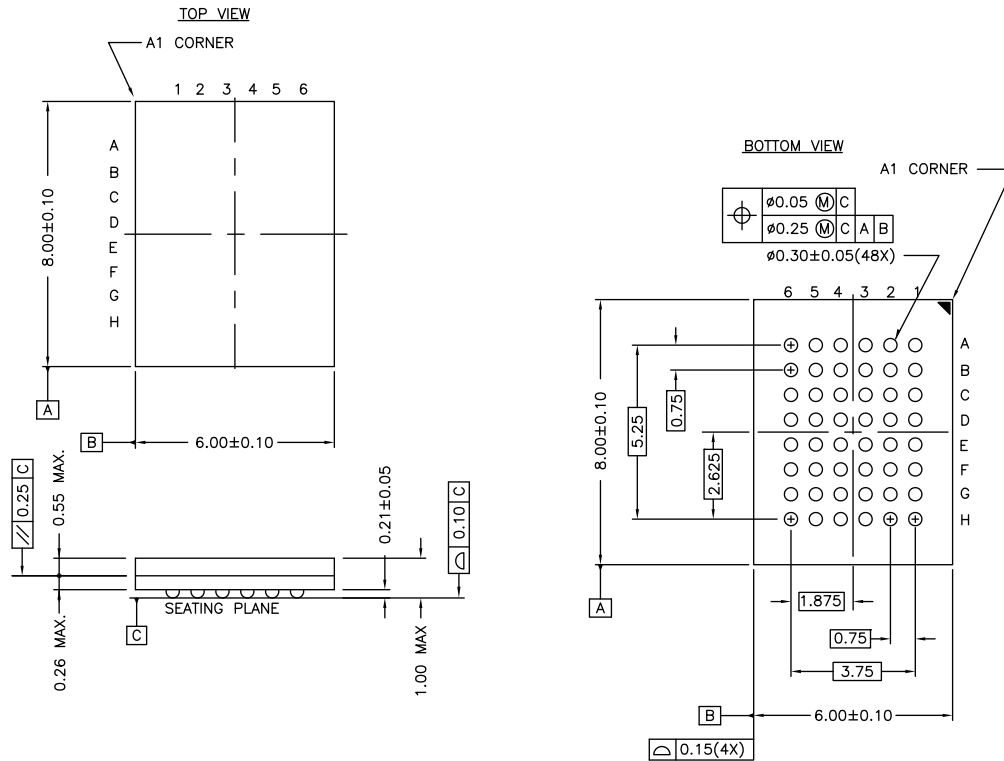

Figure 9. 44-pin TSOP Z44-II Package Outline, 51-85087



Package Diagrams (continued)

Figure 10. 48-ball VFBGA (6 × 8 × 1.0 mm) BV48/BZ48 Package Outline, 51-85150



NOTE:
 PACKAGE WEIGHT: See Cypress Package Material Declaration Datasheet (PMDD) posted on the Cypress web.

51-85150 *H

Acronyms

Acronym	Description
$\overline{\text{BHE}}$	Byte High Enable
$\overline{\text{BLE}}$	Byte Low Enable
CMOS	Complementary Metal Oxide Semiconductor
$\overline{\text{CE}}$	Chip Enable
I/O	Input/Output
$\overline{\text{OE}}$	Output Enable
SOJ	Small-Outline J-leaded
SRAM	Static Random Access Memory
TSOP	Thin Small-Outline Package
TTL	Transistor-Transistor Logic
VFBGA	Very Fine-Pitch Ball Grid Array
$\overline{\text{WE}}$	Write Enable

Document Conventions

Units of Measure

Symbol	Unit of Measure
°C	degree Celsius
MHz	megahertz
μA	microampere
μs	microsecond
mA	milliampere
ns	nanosecond
%	percent
pF	picofarad
V	volt
W	watt

Document History Page

Document Title: CY7C1021DV33, 1-Mbit (64 K × 16) Static RAM Document Number: 38-05460				
Rev.	ECN No.	Issue Date	Orig. of Change	Description of Change
**	201560	See ECN	SWI	Advance Information data sheet for C9 IPP.
*A	233693	See ECN	RKF	Updated Electrical Characteristics (modified as per Eros (Spec # 01-02165)). Updated Ordering Information (included Pb-free offering).
*B	263769	See ECN	RKF	Updated Functional Description (Changed I/O ₁ –I/O ₁₆ to I/O ₀ –I/O ₁₅). Updated Pin Configurations (Changed I/O ₁ –I/O ₁₆ to I/O ₀ –I/O ₁₅). Added Data Retention Characteristics and Data Retention Waveform . Updated Switching Characteristics (Added T _{power} parameter and its details). Updated Ordering Information (Added shade, no change in part numbers).
*C	307601	See ECN	RKF	Updated Selection Guide (Reduced Speed bins to -8 and -10 ns (Removed -12 and -15 speed bins related information)). Updated Electrical Characteristics (Reduced Speed bins to -8 and -10 ns (Removed -12 and -15 speed bins related information)). Updated Switching Characteristics (Reduced Speed bins to -8 and -10 ns (Removed -12 and -15 speed bins related information)). Updated Ordering Information (Updated part numbers).
*D	520652	See ECN	VKN	Changed status from Preliminary to Final. Updated Features (Removed Commercial Operating range related information and included Automotive-A, Automotive-E Operating range related information). Updated Selection Guide (Removed -8 speed bin related information and included -12 speed bin related information). Updated Operating Range (Removed Commercial Operating range related information and included Automotive-A, Automotive-E Operating range related information). Updated Electrical Characteristics (Updated DC Electrical Characteristics (Removed -8 speed bin related information and included -12 speed bin related information, removed Commercial Operating range related information and included Automotive-A, Automotive-E Operating range related information), Updated Note 2 (Changed V _{IH(max)} from V _{CC} + 2 V to V _{CC} + 1 V), added I _{CC} parameter values for the frequencies 83 MHz, 66 MHz and 40 MHz). Updated Thermal Resistance (Replaced TBD with values for all packages). Updated Switching Characteristics (Removed -8 speed bin related information and included -12 speed bin related information, removed Commercial Operating range related information and included Automotive-A, Automotive-E Operating range related information). Updated Data Retention Characteristics (Removed Commercial Operating range related information and included Automotive-A, Automotive-E Operating range related information). Updated Ordering Information (Updated part numbers).
*E	2898399	03/24/2010	AJU	Updated Package Diagrams .
*F	3109897	12/14/2010	AJU	Added Ordering Code Definitions . Updated Package Diagrams .

Document History Page (continued)

Document Title: CY7C1021DV33, 1-Mbit (64 K × 16) Static RAM				
Document Number: 38-05460				
Rev.	ECN No.	Issue Date	Orig. of Change	Description of Change
*G	3421856	10/25/2011	TAVA	<p>Updated Features (Removed Automotive-E Operating range related information).</p> <p>Updated Selection Guide (Removed Automotive-E Operating range related information, removed -12 speed bin related information).</p> <p>Updated Operating Range (Removed Automotive-E Operating range related information, removed -12 speed bin related information).</p> <p>Updated Electrical Characteristics (Updated DC Electrical Characteristics (Removed Automotive-E Operating range related information, removed -12 speed bin related information)).</p> <p>Updated Switching Characteristics (Removed Automotive-E Operating range related information, removed -12 speed bin related information).</p> <p>Updated Data Retention Characteristics (Removed Automotive-E Operating range related information).</p> <p>Updated Switching Waveforms.</p> <p>Updated Ordering Information (Updated part numbers).</p> <p>Updated Package Diagrams.</p> <p>Updated to new template.</p>
*H	4578364	11/24/2014	MEMJ	<p>Updated Functional Description:</p> <p>Added "For a complete list of related resources, click here." at the end.</p> <p>Updated Switching Characteristics:</p> <p>Added Note 13 and referred the same note in "Write Cycle".</p> <p>Updated Switching Waveforms:</p> <p>Added Note 19 and referred the same note in Figure 7.</p> <p>Updated Ordering Information (Removed shade, no change in part numbers).</p> <p>Updated Package Diagrams:</p> <p>spec 51-85082 – Changed revision from *D to *E.</p> <p>spec 51-85087 – Changed revision from *D to *E.</p> <p>spec 51-85150 – Changed revision from *G to *H.</p> <p>Added Acronyms and Units of Measure.</p> <p>Updated to new template.</p> <p>Completing Sunset Review.</p>

Sales, Solutions, and Legal Information

Worldwide Sales and Design Support

Cypress maintains a worldwide network of offices, solution centers, manufacturer's representatives, and distributors. To find the office closest to you, visit us at [Cypress Locations](#).

Products

Automotive	cypress.com/go/automotive
Clocks & Buffers	cypress.com/go/clocks
Interface	cypress.com/go/interface
Lighting & Power Control	cypress.com/go/powerpsoc cypress.com/go/plc
Memory	cypress.com/go/memory
PSoC	cypress.com/go/psoc
Touch Sensing	cypress.com/go/touch
USB Controllers	cypress.com/go/USB
Wireless/RF	cypress.com/go/wireless

PSoC[®] Solutions

[psoc.cypress.com/solutions](#)
[PSoC 1](#) | [PSoC 3](#) | [PSoC 4](#) | [PSoC 5LP](#)

Cypress Developer Community

[Community](#) | [Forums](#) | [Blogs](#) | [Video](#) | [Training](#)

Technical Support

[cypress.com/go/support](#)

© Cypress Semiconductor Corporation, 2004-2014. The information contained herein is subject to change without notice. Cypress Semiconductor Corporation assumes no responsibility for the use of any circuitry other than circuitry embodied in a Cypress product. Nor does it convey or imply any license under patent or other rights. Cypress products are not warranted nor intended to be used for medical, life support, life saving, critical control or safety applications, unless pursuant to an express written agreement with Cypress. Furthermore, Cypress does not authorize its products for use as critical components in life-support systems where a malfunction or failure may reasonably be expected to result in significant injury to the user. The inclusion of Cypress products in life-support systems application implies that the manufacturer assumes all risk of such use and in doing so indemnifies Cypress against all charges.

Any Source Code (software and/or firmware) is owned by Cypress Semiconductor Corporation (Cypress) and is protected by and subject to worldwide patent protection (United States and foreign), United States copyright laws and international treaty provisions. Cypress hereby grants to licensee a personal, non-exclusive, non-transferable license to copy, use, modify, create derivative works of, and compile the Cypress Source Code and derivative works for the sole purpose of creating custom software and or firmware in support of licensee product to be used only in conjunction with a Cypress integrated circuit as specified in the applicable agreement. Any reproduction, modification, translation, compilation, or representation of this Source Code except as specified above is prohibited without the express written permission of Cypress.

Disclaimer: CYPRESS MAKES NO WARRANTY OF ANY KIND, EXPRESS OR IMPLIED, WITH REGARD TO THIS MATERIAL, INCLUDING, BUT NOT LIMITED TO, THE IMPLIED WARRANTIES OF MERCHANTABILITY AND FITNESS FOR A PARTICULAR PURPOSE. Cypress reserves the right to make changes without further notice to the materials described herein. Cypress does not assume any liability arising out of the application or use of any product or circuit described herein. Cypress does not authorize its products for use as critical components in life-support systems where a malfunction or failure may reasonably be expected to result in significant injury to the user. The inclusion of Cypress' product in a life-support systems application implies that the manufacturer assumes all risk of such use and in doing so indemnifies Cypress against all charges.

Use may be limited by and subject to the applicable Cypress software license agreement.

Mouser Electronics

Authorized Distributor

Click to View Pricing, Inventory, Delivery & Lifecycle Information:

[Infineon:](#)

[CY7C1021DV33-10BVXI](#) [CY7C1021DV33-10BVXIT](#) [CY7C1021DV33-10VXI](#) [CY7C1021DV33-10VXIT](#)
[CY7C1021DV33-10ZSXI](#) [CY7C1021DV33-10ZSXIT](#)