

□

Mini Relay FeatherWings

Created by lady ada

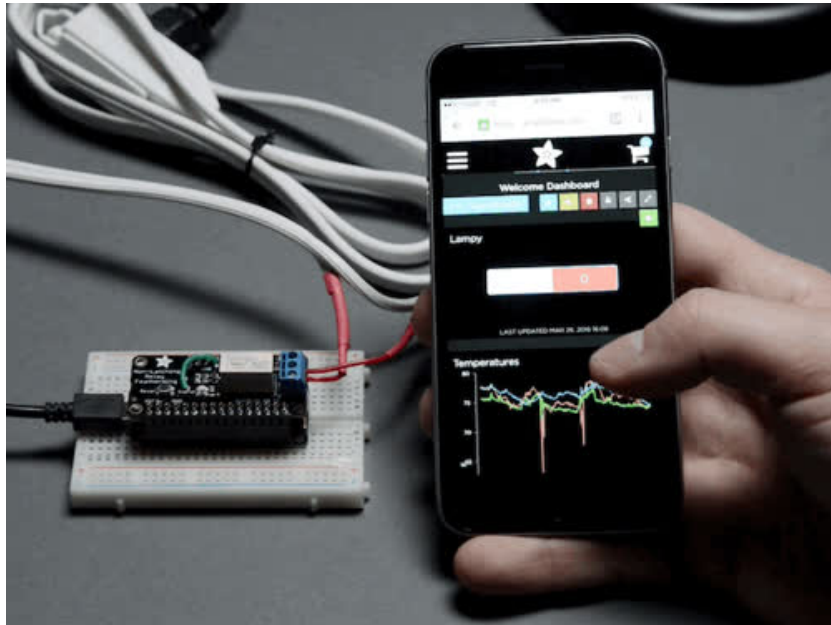

Last updated on 2016-09-15 07:10:46 PM UTC

Guide Contents

Guide Contents	2
Overview	3
Pinouts	9
Relay Control	9
Relay Output	10
Reset Button	11
Downloads	13
Datasheets & Files	13
Non-Latching Schematic	13
Latching Schematic	13
Fabrication Print	14

Overview

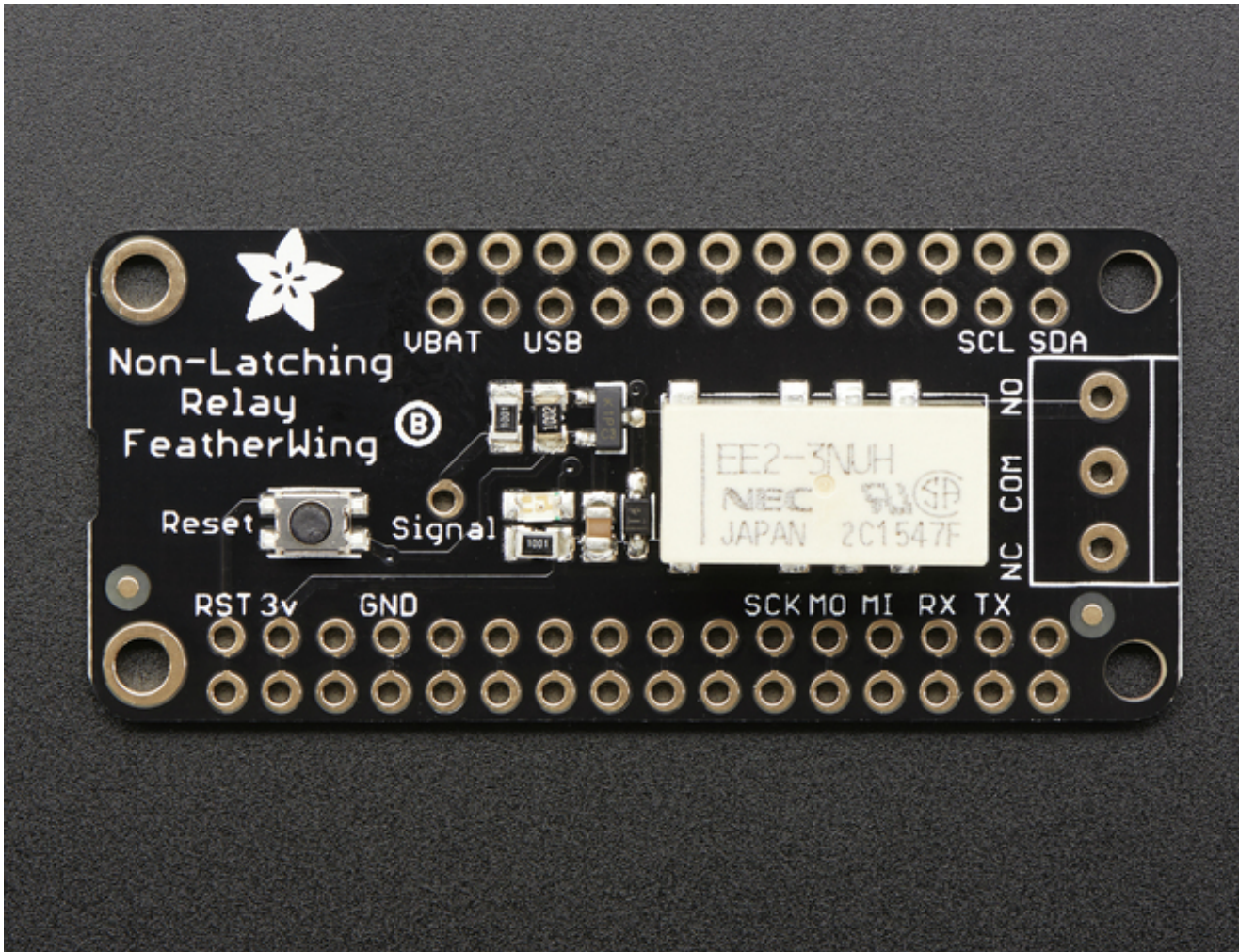

A Feather board without ambition is a Feather board without FeatherWings! These are the **Mini Relay FeatherWing**. They will give you power to control, and control over power. Put simply, you can now turn on and off lamps, fans, solenoids, and other small appliances that run on up to 250VAC or DC power using any Feather board.

Using our [Feather Stacking Headers \(http://adafru.it/2830\)](http://adafru.it/2830) or [Feather Female Headers \(http://adafru.it/2886\)](http://adafru.it/2886) you can connect a FeatherWing on top of your Feather board and let the board take flight. [Check out our range of Feather boards here. \(http://adafru.it/17B\)](http://adafru.it/17B)

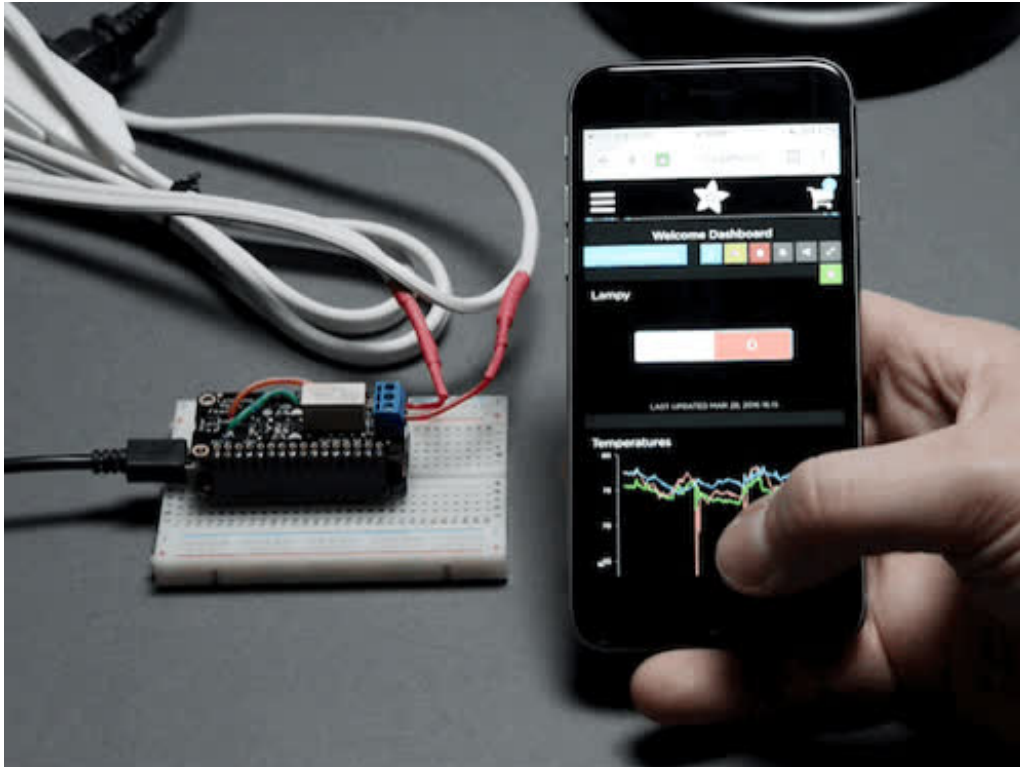

There are two 'flavors' of these FeatherWings, the first is the simple **Non-Latching** relay. This Wing has a single Set pin. Normally, the **COM** pin is connected mechanically to the **NC** pin and the **NO** pin is disconnected.

When the SET pin is pulled high, the relay switches and the internal switch changes so that the **COM** pin is mechanically connected to the **NO** pin and **NC** is then disconnected.

When the relay is active, a red LED is lit, and about 50mA of current is used to keep the coil switched on. Note, if power is lost, the relay will go back 'open'.

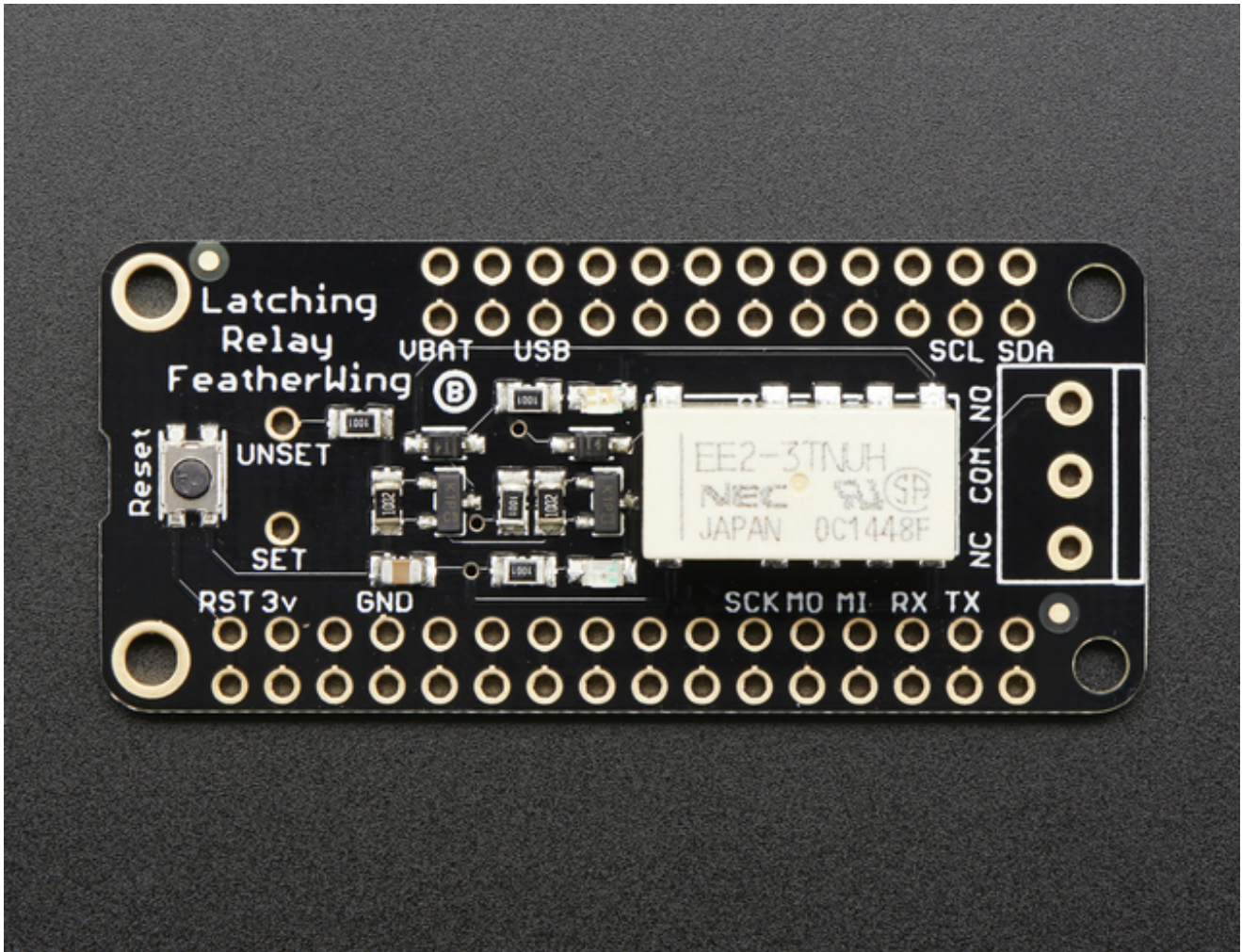

Now, you might be thinking "wow I really don't want to waste 50mA of current, that will really sink my battery life!". OK good news, we have another type of FeatherWing, the **Latching FeatherWing**. This one requires two pins, a **SET** and **UNSET** and instead of keeping the SET pin high, you only have to pulse each pin high for 10ms to latch the relay open or closed. You need two pins but save power. A red and green LED is tied to each control transistor so you will see the LEDs blink when you set and unset the relay

Note, if power is lost, the relay will stay in the last setting.

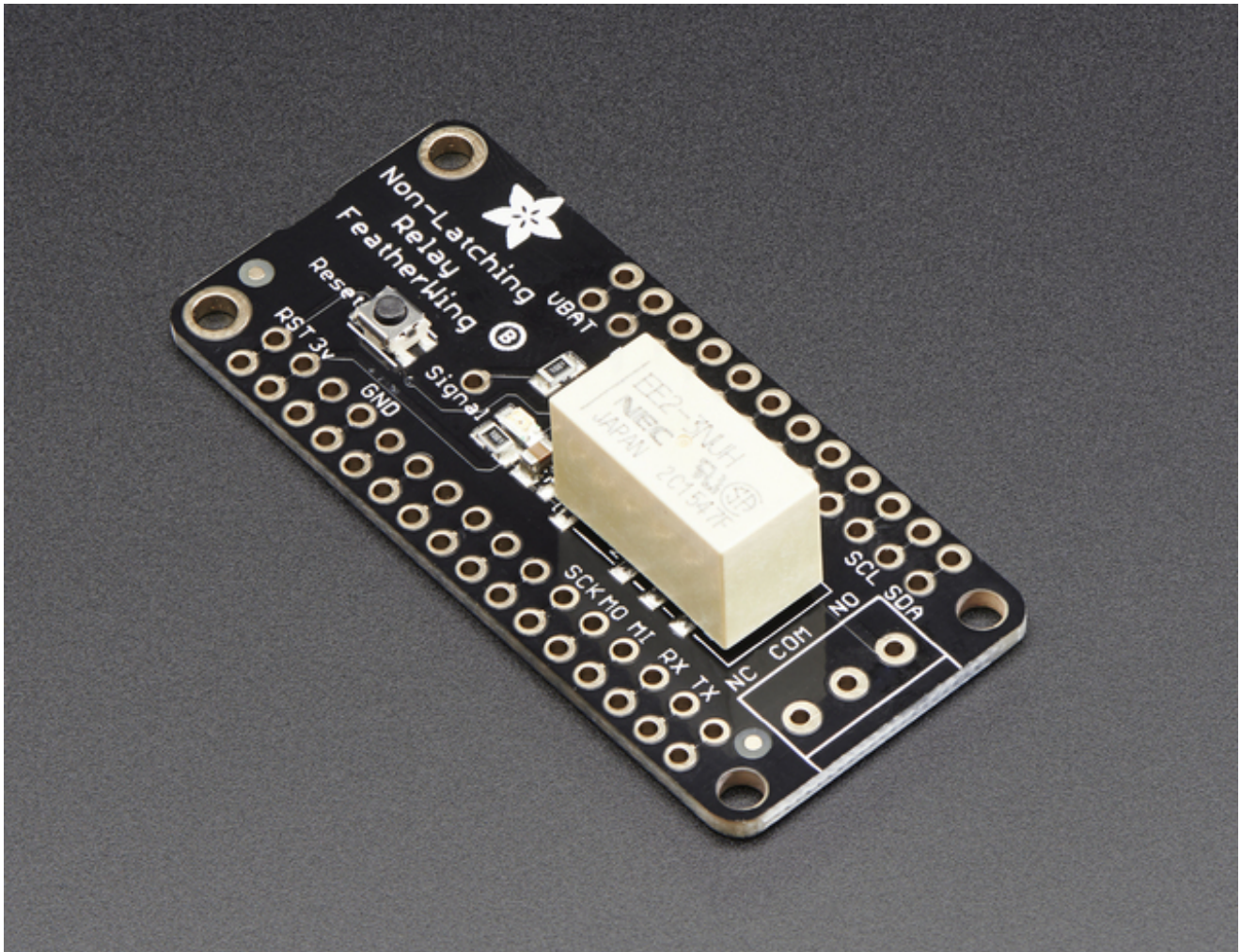

Both FeatherWings use the same family of relay. You can switch up to 2A of resistive current at 30VDC or ~40VAC or lower. At 110VDC you can switch up to 0.3A, at 120VAC up to 0.5A, and at 250VAC you can switch up to 0.6A. Check the datasheet for the relay for the exact switching capacity, and of course, for reactive/inductive loads you will need to derate. This isn't a relay you can use to turn on and off your washer/dryer, stick to 60W or less.

The coils for the relays are controlled through transistors with flyback diodes so you do not have to worry about sourcing current from the control pin.

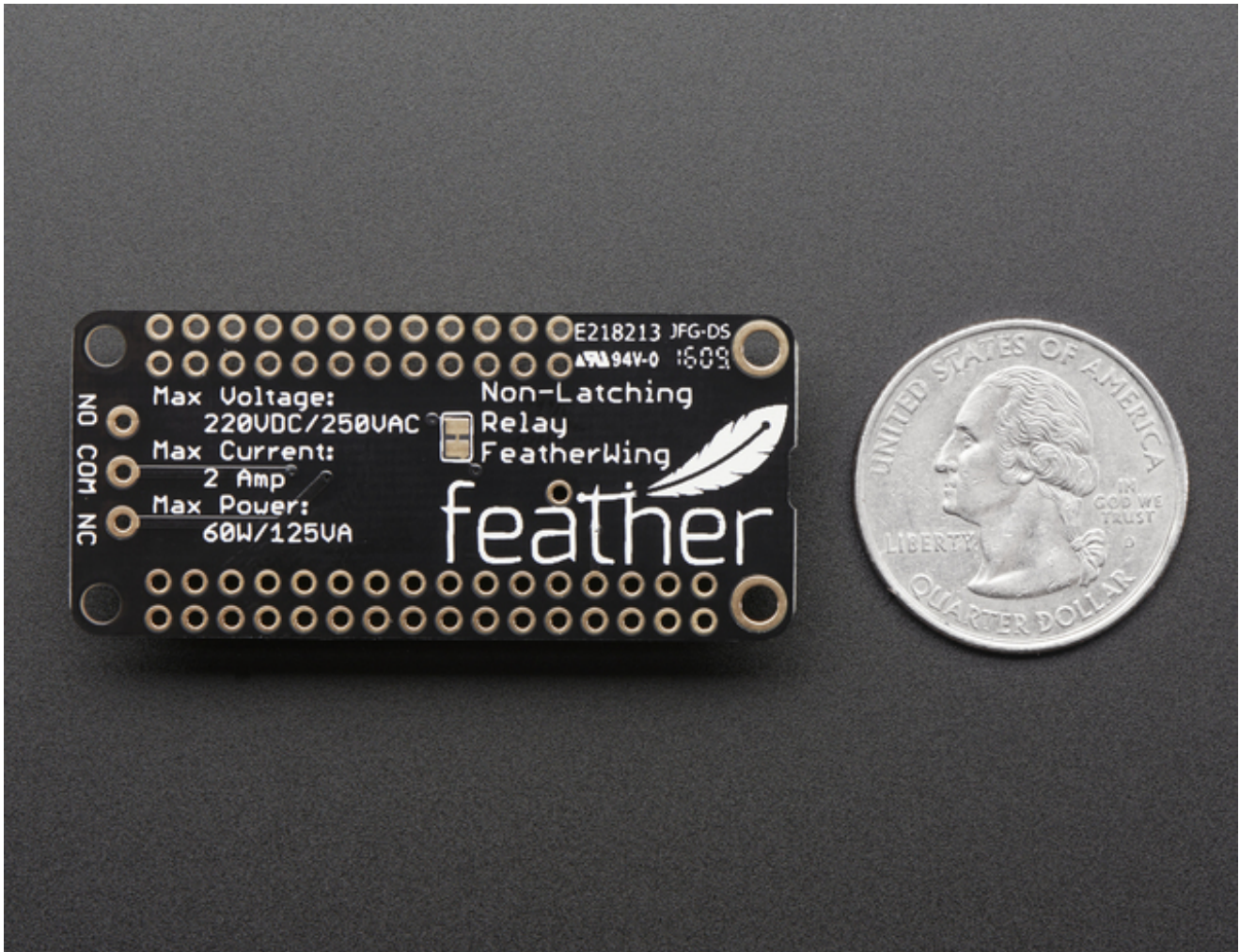

Each FeatherWing comes with a fully assembled and tested PCB, header you can use to attach to your feather. You also get a 3-pin terminal block you can use to wire up whatever you are going to be relay-controlling. Some light soldering is required

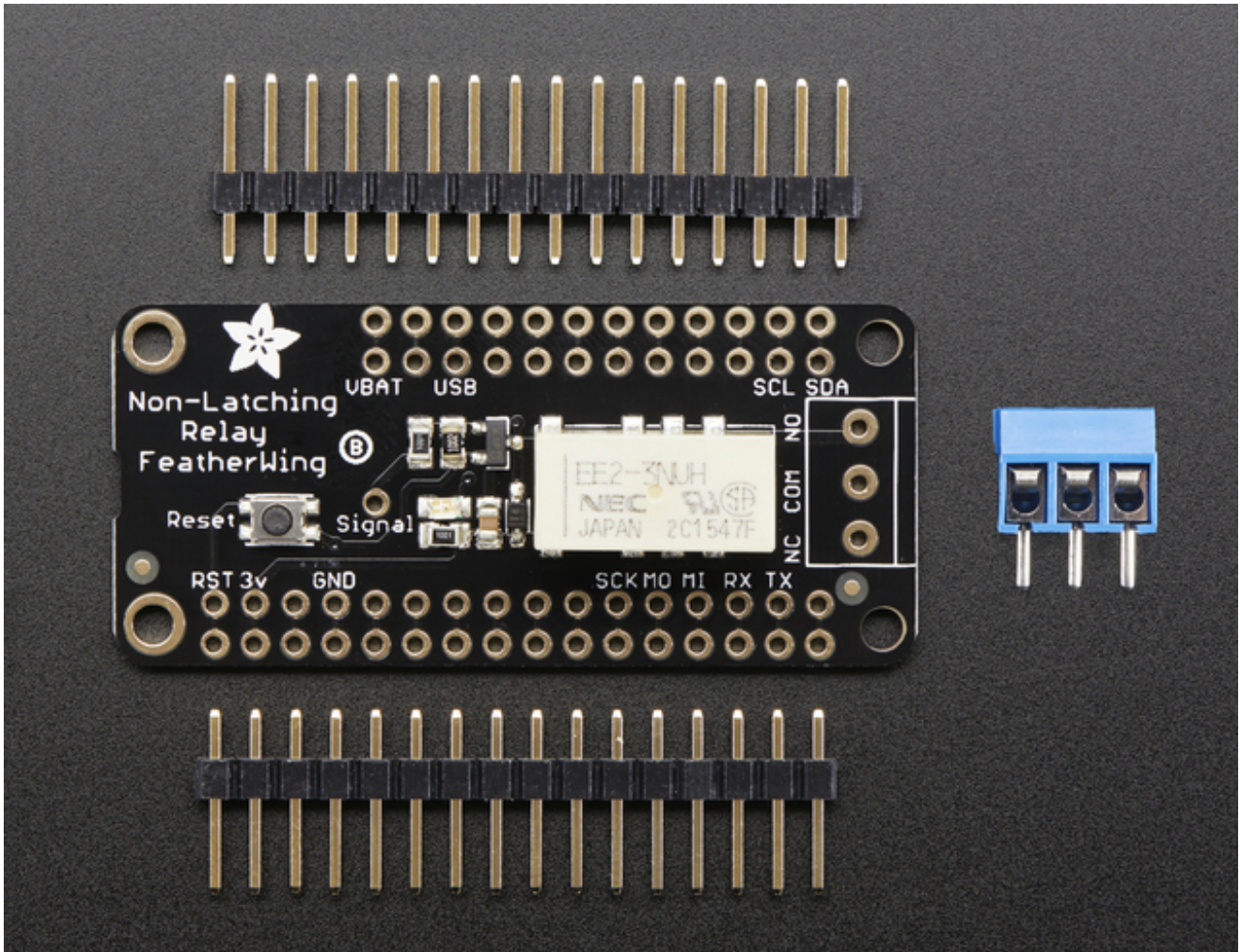

Please note: If using with high voltages (> 24V) use care and common sense! High voltages require experience, and are only for use by engineers who are comfortable with guidelines and know how to use safely!



Pinouts

Relay Control

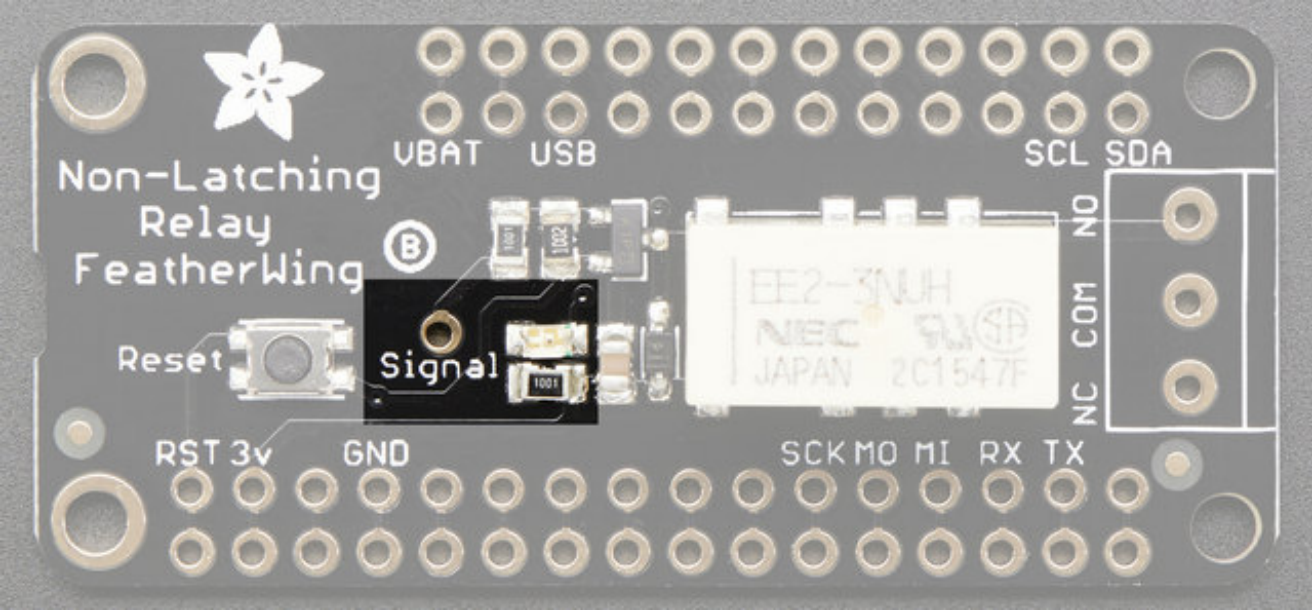

The plain relay uses a single pin for control. When floating or pulled low, the relay is 'open' or unset. When the pin is pulled high, the relay switches closed/set. A red LED next to the pin will let you know that the signal is high. You will need to solder a wire from this pin to whatever control pin you like using a wire

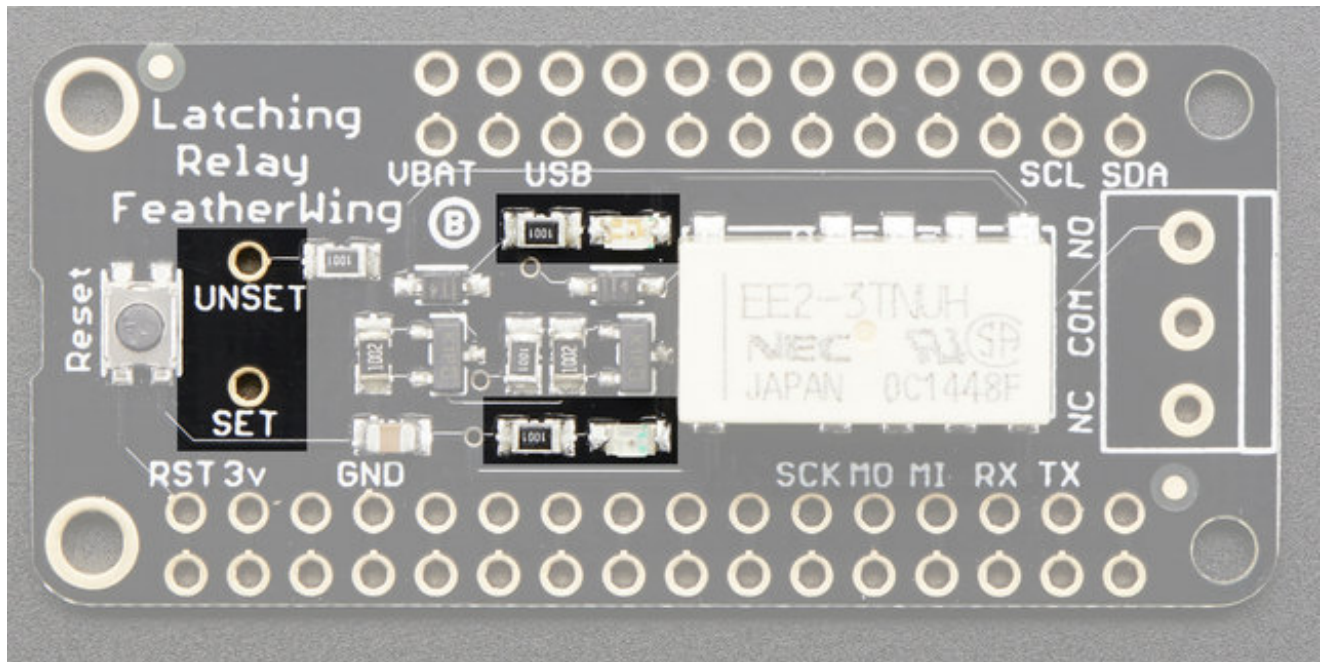

The plain relay uses two pins for control. There is no way to know which 'orientation' the relay is when the Feather turns on, because the relay will latch in the last position it was set to.

When the **SET** pin is pulled high for 10 milliseconds, the relay switches closed/set. A green LED next to the pin will let you know that the SET signal is high.

When the **UNSET** pin is pulled high for 10 milliseconds, the relay switches closed/set. A red LED next to the pin will let you know that the UNSET signal is high.

You will need to solder wires from the SET & UNSET pads to whatever control pins you like using wires

Relay Output

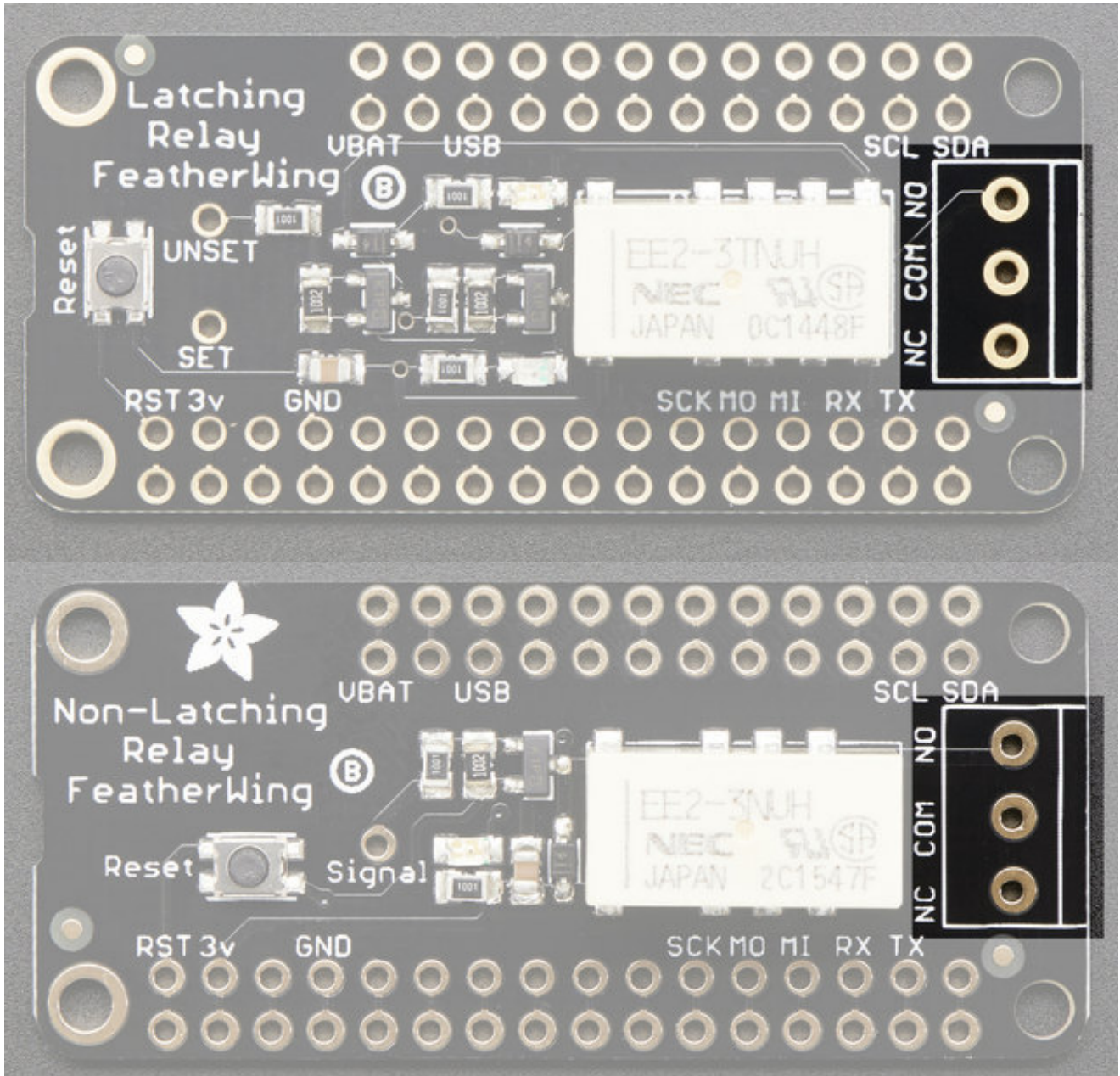

Both Wings have the same output, a 3-pin 3.5mm terminal block. The **COM** pin is what you should connect the signal you're planning to switch. If the relay is unset, the **NC** pin (Normally Connected) is mechanically connected to **COM**. **NO** (Normally Open) is mechanically disconnected.

When the relay is set, **NC** becomes disconnected from **COM** and **NO** is connected to **COM**

Reset Button

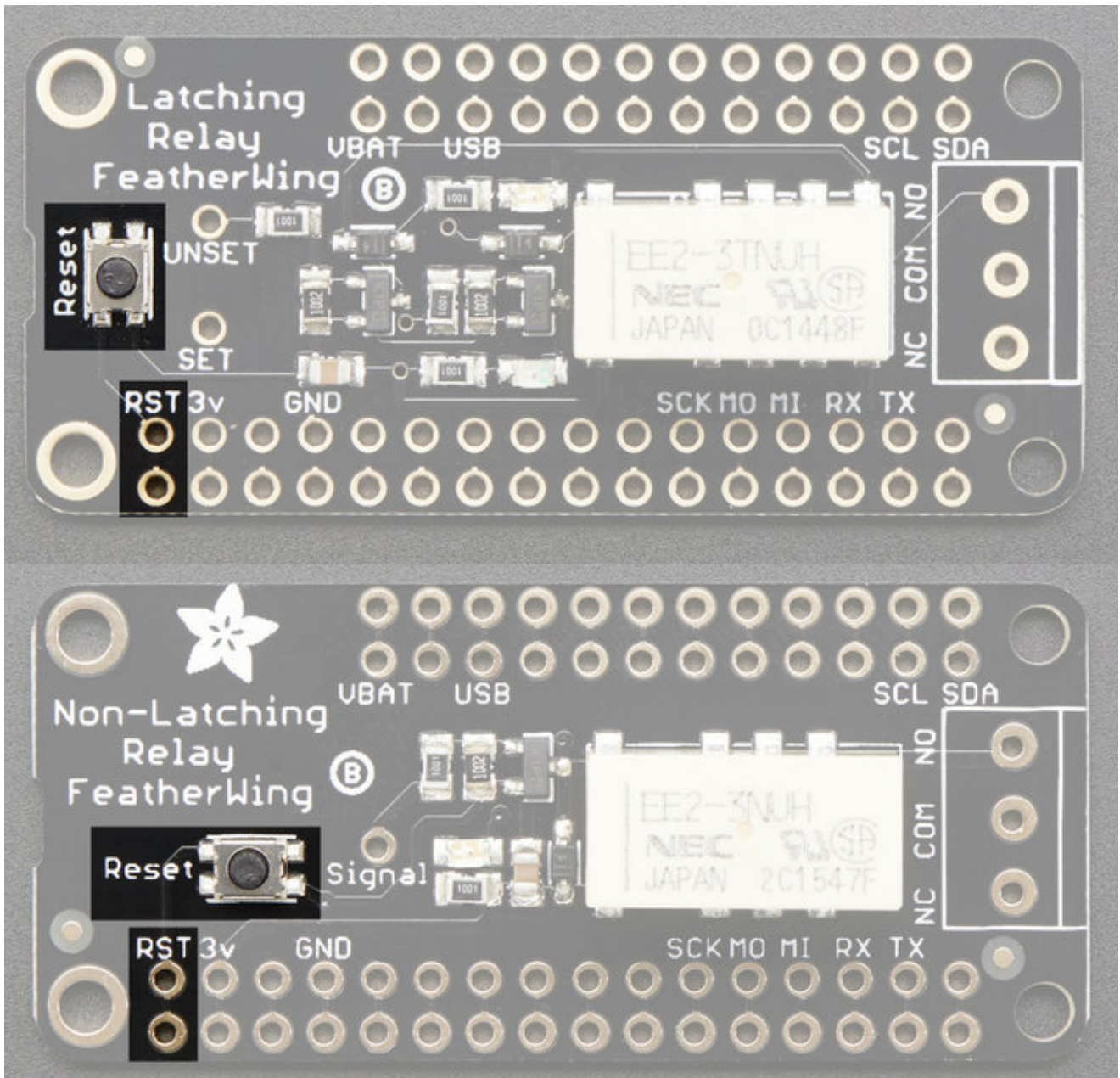

There is a Reset button on both Wings, this is connected to the **RST** pin and will short it to ground. It is not connected to the relay at all, its handy for restarting your Feather

Downloads

Datasheets & Files

- [EagleCAD Files on GitHub \(http://adafru.it/omD\)](http://adafru.it/omD)
- [Datasheet for the relays used \(http://adafru.it/msd\)](http://adafru.it/msd)
- [Fritzing object available in the Adafruit Fritzing Library\(http://adafru.it/aP3\)](http://adafru.it/aP3)

Non-Latching Schematic

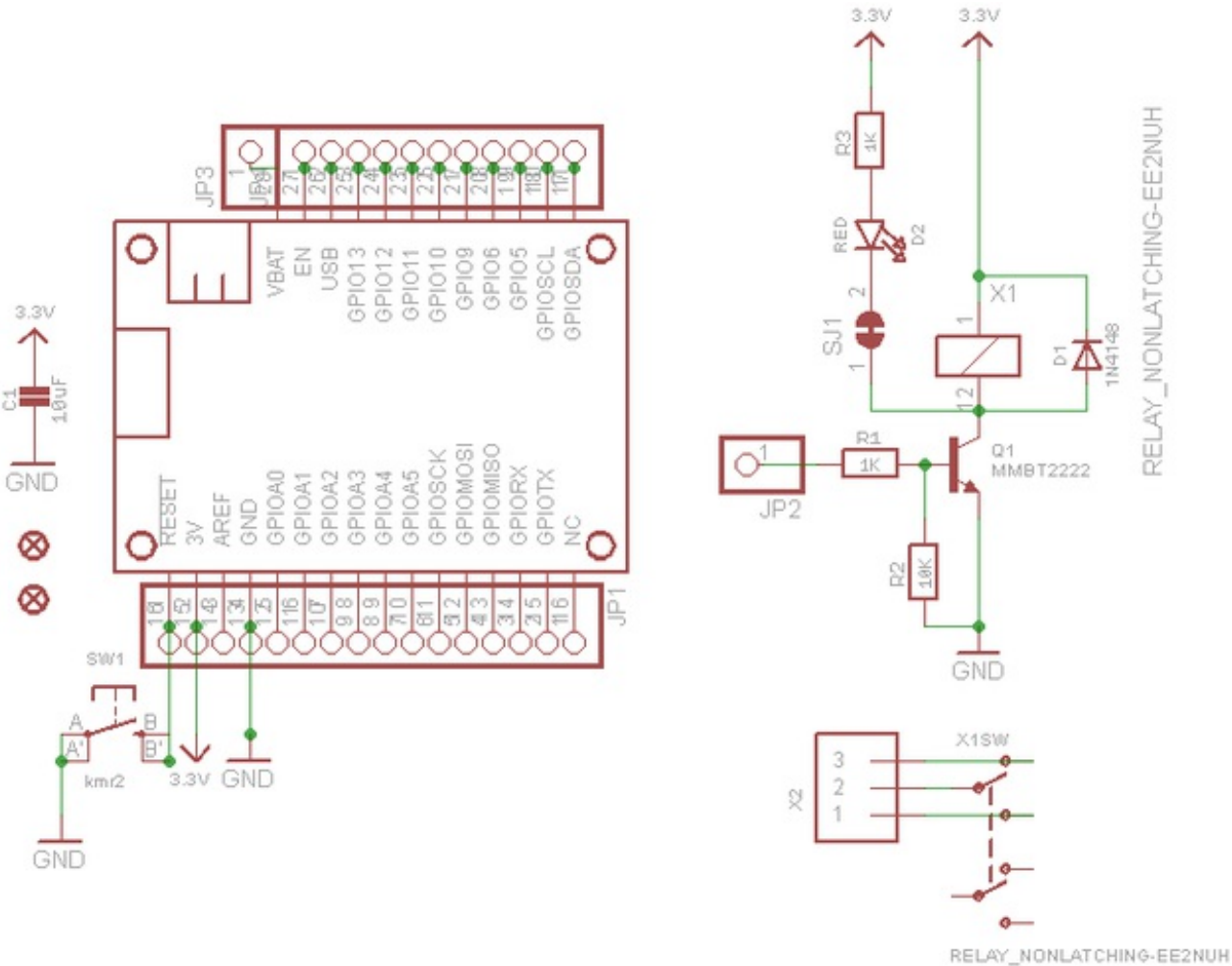

Latching Schematic

