

NPN Silicon AF Transistor Array

- For AF stages and driver applications
- High current gain
- Low collector-emitter saturation voltage
- Two (galvanic) internal isolated NPN/PNP transistors in one package
- Pb-free (RoHS compliant) package
- Qualified according AEC Q101

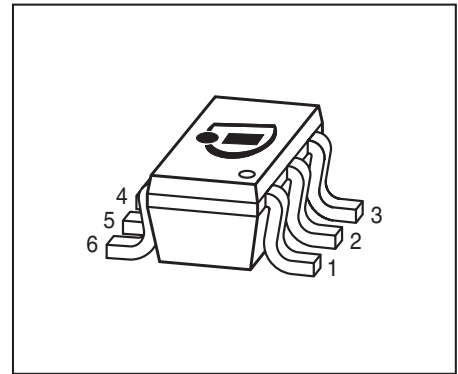

Tape loading orientation

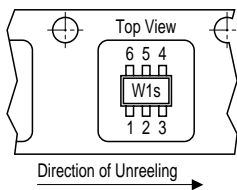

Marking on SC74 package (for example W1s) corresponds to pin 1 of device

Position in tape: pin 1 opposite of feed hole side

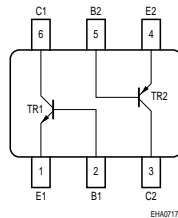

| Type | Marking | Pin Configuration | | | | | | Package |
|----------|---------|-------------------|------|------|------|------|------|---------|
| BC817UPN | 1Bs | 1=E1 | 2=B1 | 3=C2 | 4=E2 | 5=B2 | 6=C1 | SC74 |

Maximum Ratings

| Parameter | Symbol | Value | Unit |
|---|-----------|-------------|------|
| Collector-emitter voltage | V_{CEO} | 45 | V |
| Collector-base voltage | V_{CBO} | 50 | |
| Emitter-base voltage | V_{EBO} | 5 | |
| Collector current | I_C | 500 | mA |
| Peak collector current, $t_p \leq 10$ ms | I_{CM} | 1000 | |
| Base current | I_B | 100 | |
| Peak base current | I_{BM} | 200 | mW |
| Total power dissipation- $T_S \leq 115$ °C | P_{tot} | 330 | |
| Junction temperature | T_j | 150 | |
| Storage temperature | T_{stg} | -65 ... 150 | |

Thermal Resistance

| Parameter | Symbol | Value | Unit |
|--|------------|------------|------|
| Junction - soldering point ¹⁾ | R_{thJS} | ≤ 105 | K/W |

Electrical Characteristics at $T_A = 25^\circ\text{C}$, unless otherwise specified

| Parameter | Symbol | Values | | | Unit |
|-----------|--------|--------|------|------|------|
| | | min. | typ. | max. | |

DC Characteristics

| | | | | | |
|--|---------------|------------|-----|-----------|---------------|
| Collector-emitter breakdown voltage $I_C = 10\text{ mA}, I_B = 0$ | $V_{(BR)CEO}$ | 45 | - | - | V |
| Collector-base breakdown voltage $I_C = 10\text{ }\mu\text{A}, I_E = 0$ | $V_{(BR)CBO}$ | 50 | - | - | |
| Emitter-base breakdown voltage $I_E = 10\text{ }\mu\text{A}, I_C = 0$ | $V_{(BR)EBO}$ | 5 | - | - | |
| Collector-base cutoff current $V_{CB} = 25\text{ V}, I_E = 0$ $V_{CB} = 25\text{ V}, I_E = 0, T_A = 150\text{ }^\circ\text{C}$ | I_{CBO} | - | - | 0.1 50 | μA |
| Emitter-base cutoff current $V_{EB} = 4\text{ V}, I_C = 0$ | I_{EBO} | - | - | 100 | nA |
| DC current gain ²⁾ $I_C = 100\text{ mA}, V_{CE} = 1\text{ V}$ $I_C = 300\text{ mA}, V_{CE} = 1\text{ V}$ | h_{FE} | 160 100 | 250 | 400 | - |
| Collector-emitter saturation voltage ²⁾ $I_C = 500\text{ mA}, I_B = 50\text{ mA}$ | V_{CEsat} | - | - | 0.7 | V |
| Base emitter saturation voltage ²⁾ $I_C = 500\text{ mA}, I_B = 50\text{ mA}$ | V_{BEsat} | - | - | 1.2 | |

AC Characteristics

| | | | | | |
|---|----------|---|-----|---|-----|
| Transition frequency $I_C = 50\text{ mA}, V_{CE} = 5\text{ V}, f = 100\text{ MHz}$ | f_T | - | 170 | - | MHz |
| Collector-base capacitance $f = 1\text{ MHz}, V_{BE} = 10\text{ V}$ | C_{cb} | - | 6 | - | pF |
| Emitter-base capacitance $V_{EB} = 0.5\text{ V}, f = 1\text{ MHz}$ | C_{eb} | - | 60 | - | |

¹⁾For calculation of R_{thJA} please refer to Application Note AN077 (Thermal Resistance Calculation)

²⁾Pulse test: $t < 300\mu\text{s}; D < 2\%$

DC current gain $h_{FE} = f(I_C)$

$V_{CE} = 1\text{ V}$

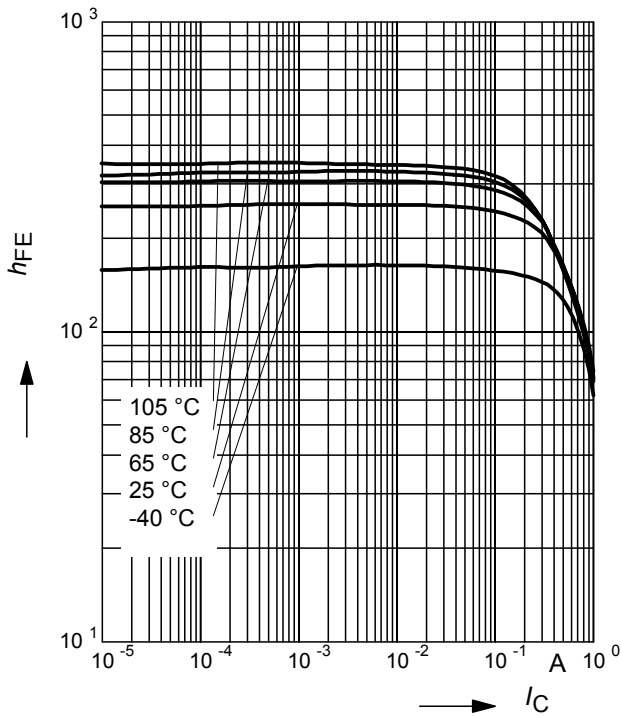

Collector-emitter saturation voltage

$I_C = f(V_{CEsat}), h_{FE} = 10$

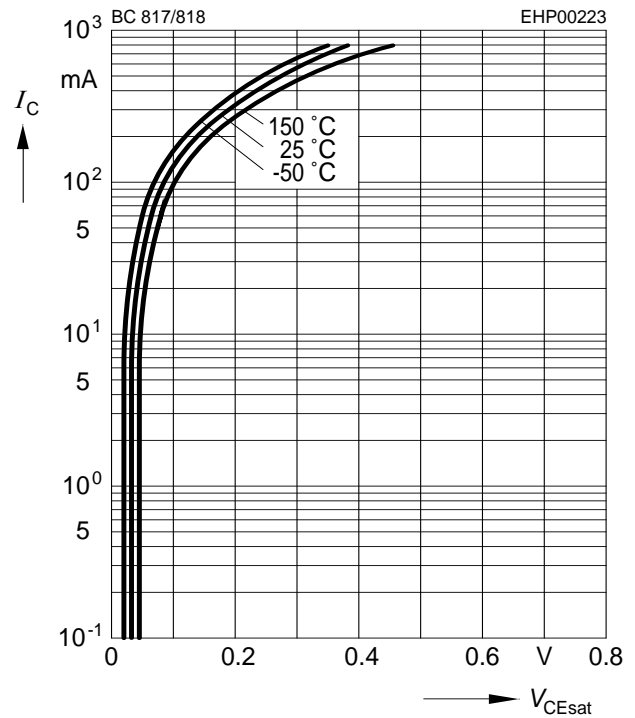

Base-emitter saturation voltage

$I_C = f(V_{BEsat}), h_{FE} = 10$

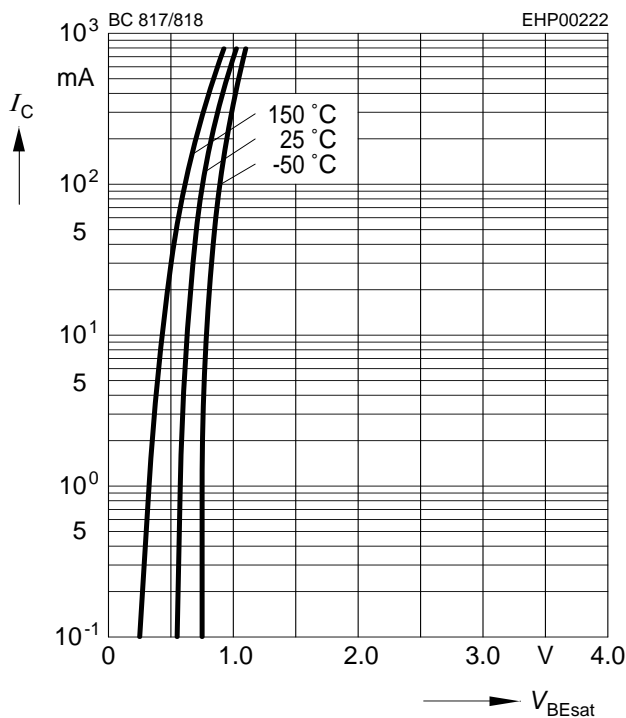

Collector cutoff current $I_{CBO} = f(T_A)$

$V_{CBO} = 25\text{ V}$

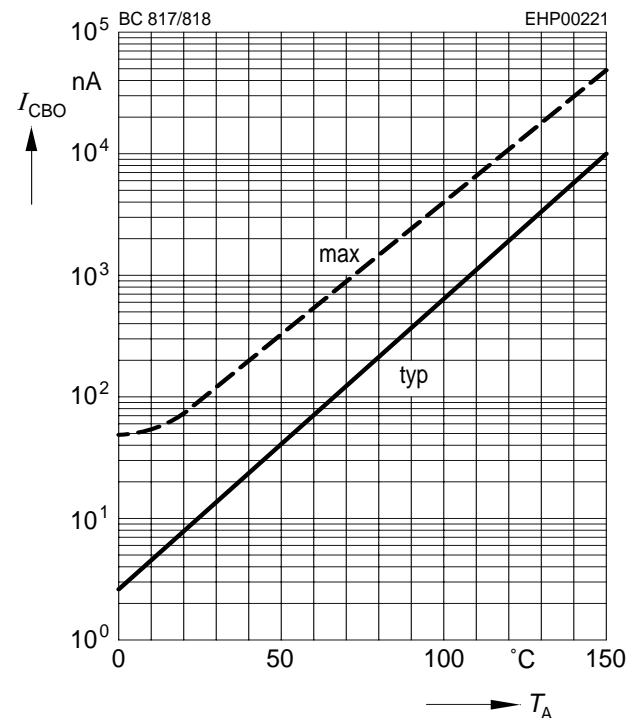

Transition frequency $f_T = f(I_C)$

V_{CE} = parameter in V, $f = 2$ GHz

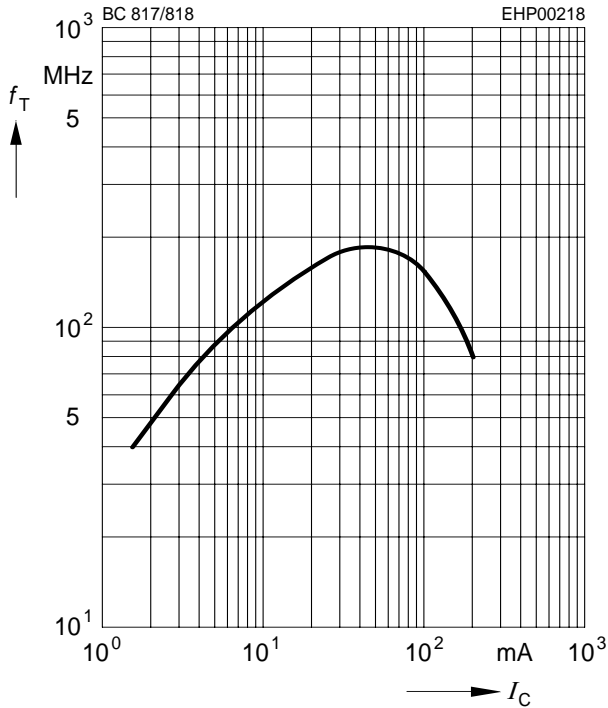

Collector-base capacitance $C_{cb} = f(V_{CB})$

Emitter-base capacitance $C_{eb} = f(V_{EB})$

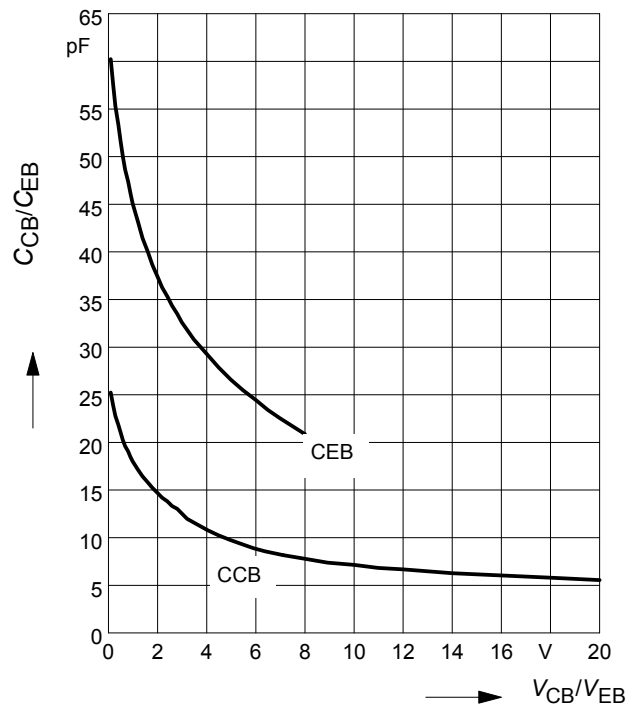

Total power dissipation $P_{tot} = f(T_S)$

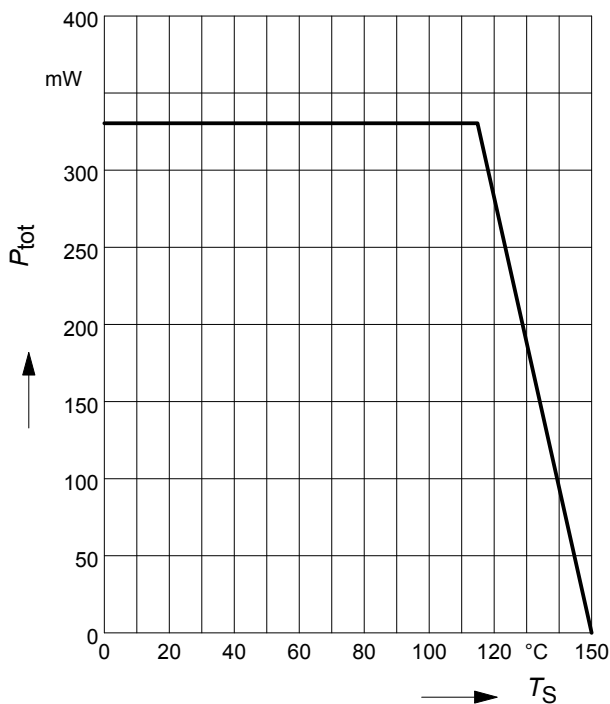

Permissible Pulse Load $R_{thJS} = f(t_p)$

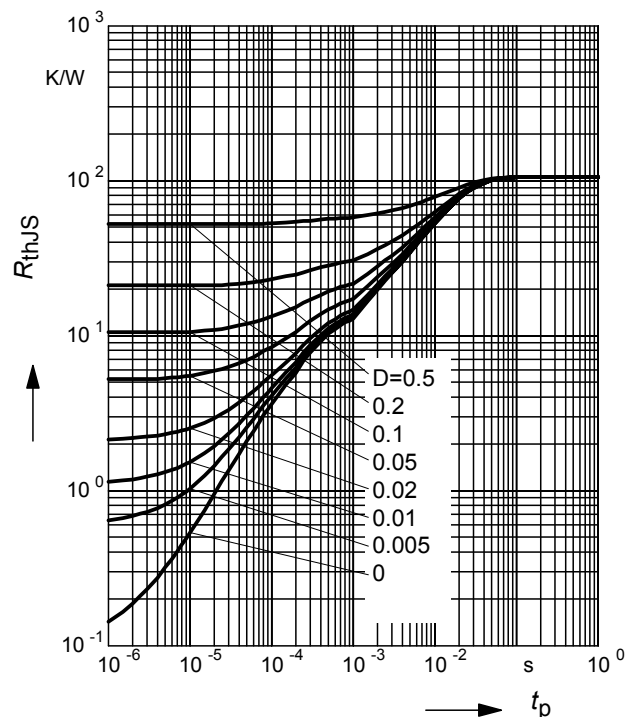

Permissible Pulse Load

$$P_{\text{totmax}}/P_{\text{totDC}} = f(t_p)$$

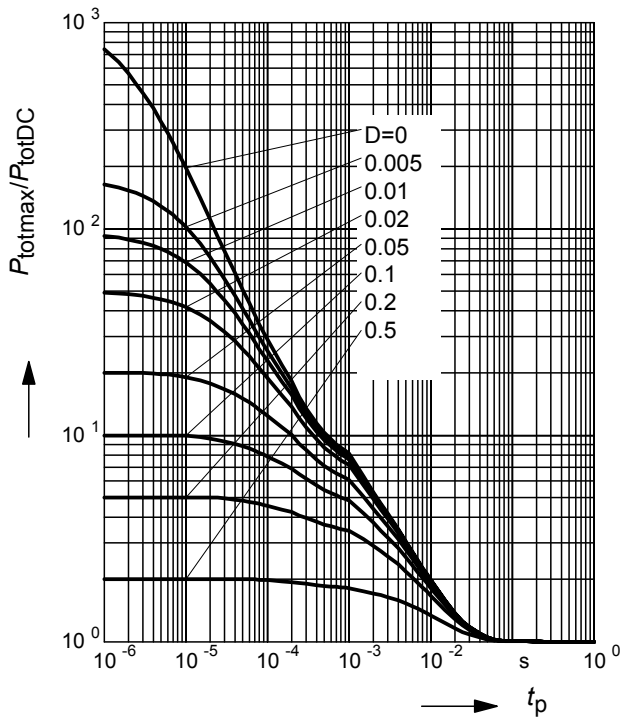

Package Outline



Foot Print

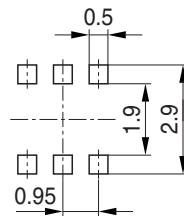

Marking Layout (Example)

Small variations in positioning of Date code, Type code and Manufacture are possible.

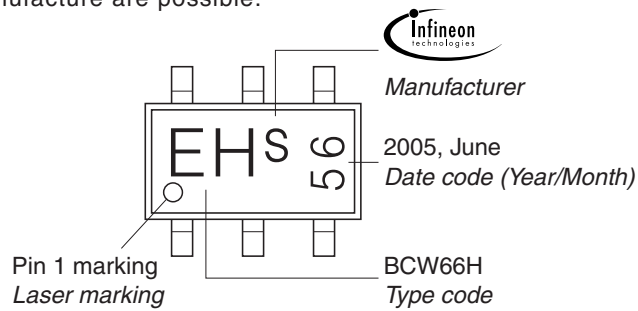

Standard Packing

Reel \varnothing 180 mm = 3.000 Pieces/Reel
 Reel \varnothing 330 mm = 10.000 Pieces/Reel

For symmetric types no defined Pin 1 orientation in reel.

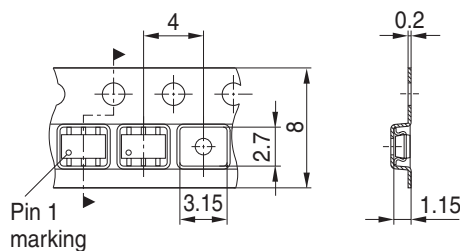

Edition 2009-11-16

**Published by
Infineon Technologies AG
81726 Munich, Germany**

**© 2009 Infineon Technologies AG
All Rights Reserved.**

Legal Disclaimer

The information given in this document shall in no event be regarded as a guarantee of conditions or characteristics. With respect to any examples or hints given herein, any typical values stated herein and/or any information regarding the application of the device, Infineon Technologies hereby disclaims any and all warranties and liabilities of any kind, including without limitation, warranties of non-infringement of intellectual property rights of any third party.

Information

For further information on technology, delivery terms and conditions and prices, please contact the nearest Infineon Technologies Office (www.infineon.com).

Warnings

Due to technical requirements, components may contain dangerous substances. For information on the types in question, please contact the nearest Infineon Technologies Office.

Infineon Technologies components may be used in life-support devices or systems only with the express written approval of Infineon Technologies, if a failure of such components can reasonably be expected to cause the failure of that life-support device or system or to affect the safety or effectiveness of that device or system. Life support devices or systems are intended to be implanted in the human body or to support and/or maintain and sustain and/or protect human life. If they fail, it is reasonable to assume that the health of the user or other persons may be endangered.

Mouser Electronics

Authorized Distributor

Click to View Pricing, Inventory, Delivery & Lifecycle Information:

[Infineon:](#)

[BC 817UPN E6327](#) [BC 817UPN B6327](#) [BC817UPNE6327HTSA1](#)