

THIS DRAWING IS UNPUBLISHED.

RELEASED FOR PUBLICATION

ALL RIGHTS RESERVED.

© COPYRIGHT - By -

LOC J

DIST -

REVISIONS

変更

DESCRIPTION

DATE

DWN

APVD

P

LTR

REVISED PER ECO-11-005140

28MAR11

RK

HMR

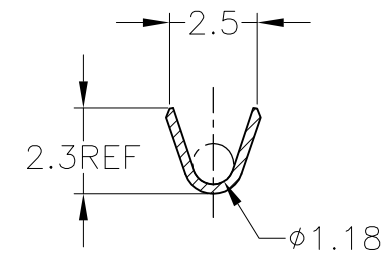
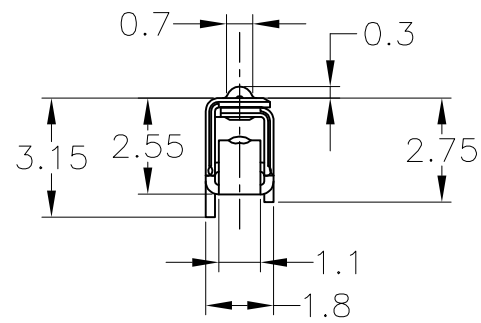
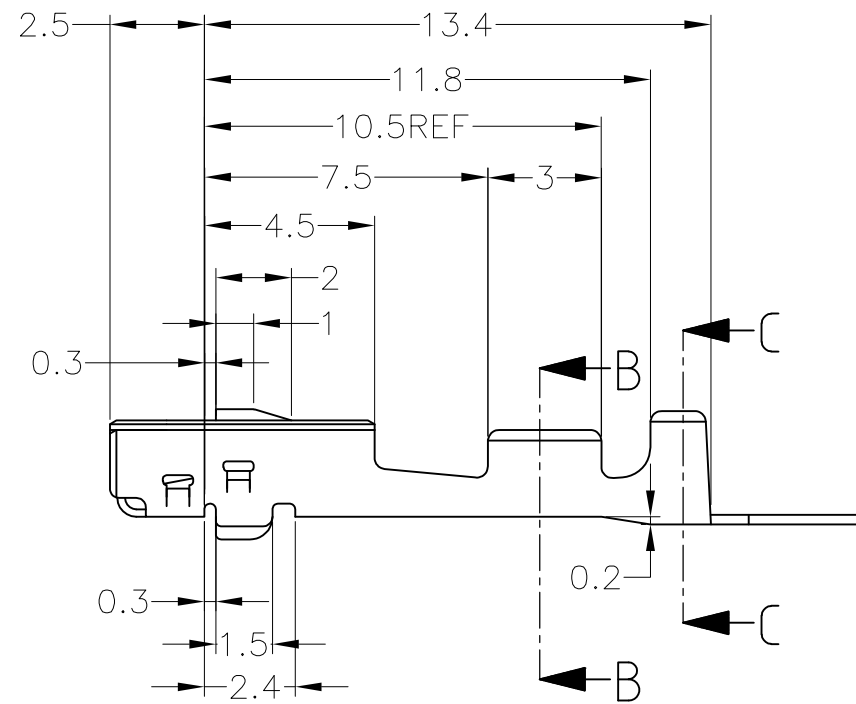
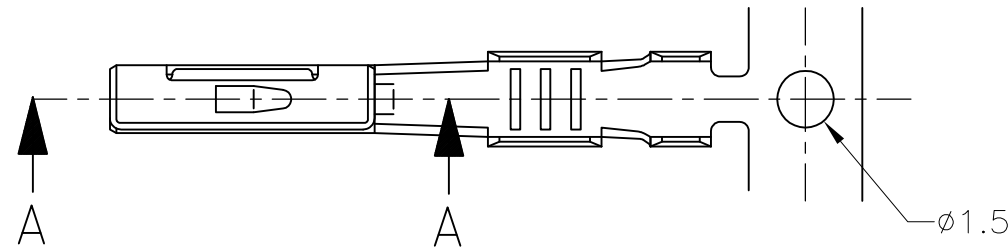

SECT. B-B

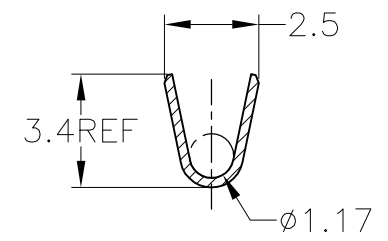

SECT. C-C

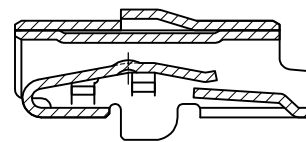

SECT. A-A

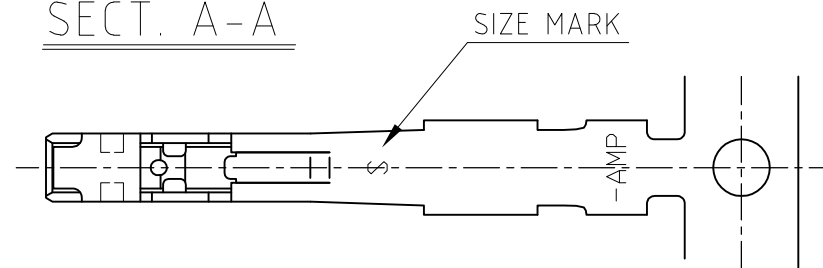

- 1. 適用電線 ; AVSS, CAVS, CAVUS 0.3~0.85mm<sup>2</sup>  
AVS 0.3~0.5mm<sup>2</sup>  
但し、使用するコネクタによって  
適用電線が制限される場合がある
- 2. 取付適用規格番号 ; 114-5217

- 1. APPLICABLE WIRE RANGE;  
AVSS, CAVS, CAVUS 0.3~0.85mm<sup>2</sup>  
AVS 0.3~0.5mm<sup>2</sup>  
BUT, AN APPLIED CONNECTOR OFTEN MAKE  
THE APPLICABLE WIRE RANGE NARROW
- 2. APPLICATION SPEC NO; 114-5217

SEE DRAWING 316836-2	316836-2
PRE-TIN	316836-1
FINISH	PART NUMBER

TOLERANCES UNLESS OTHERWISE SPECIFIED: 一般公差	
10 ≥	±0.2
30 ≥ > 10	±0.25
100 ≥ > 30	±0.3
ANGLE	±3°

THIS DRAWING IS A CONTROLLED DOCUMENT.	
DIMENSIONS: 単位: 耗 mm	TOLERANCES UNLESS OTHERWISE SPECIFIED: 一般公差
	0 PLC ± -
	1 PLC ± -
	2 PLC ± -
	3 PLC ± -
	4 PLC ± -
	ANGLES ± -
MATERIAL 材料 Cu ALLOY	FINISH 仕上 SEE TABLE

DWN M.SUGAWARA	17MAY06
CHK T.SHINOHARA	17MAY06
APVD K.BETSUI	17MAY06
PRODUCT SPEC 製品規格	
APPLICATION SPEC 取付適用規格	114-5217
WEIGHT	0.27g

TE Connectivity		NAME 名称	
		040 III UNSEALED CONTACT RECEPTACLE (S) Sn	
SIZE	CAGE CODE	DRAWING NO 番号	RESTRICTED TO
A3	00779	C-316836	-
CUSTOMER DRAWING		SCALE 尺度 5:1	SHEET 1 OF 1
		REV P	