

THIS DRAWING IS UNPUBLISHED.

RELEASED FOR PUBLICATION

ALL RIGHTS RESERVED.

© COPYRIGHT - By -

LOC J

DIST -

REVISIONS

変更

DESCRIPTION

DATE

DWN

APVD

P

LTR

REVISD PER ECO-11-005140

07APR11

RK

HMR

注：
△部分金めっき

NOTE：
△SELECTIVE GOLD

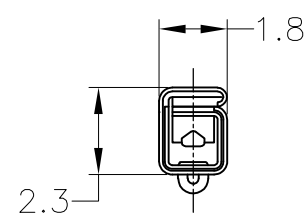
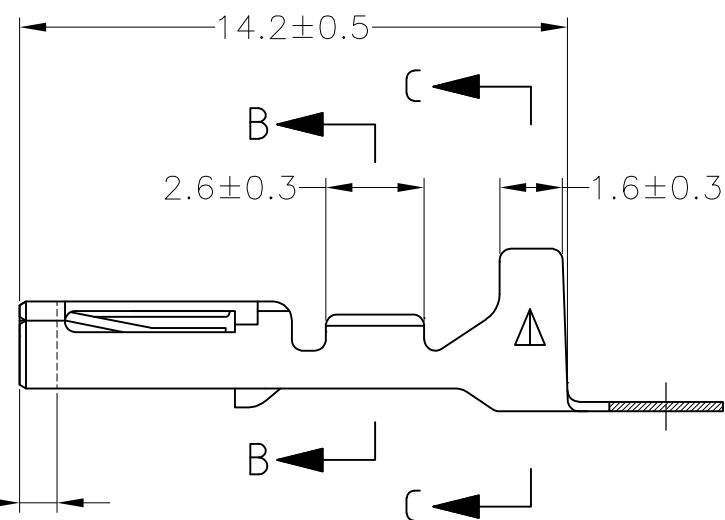
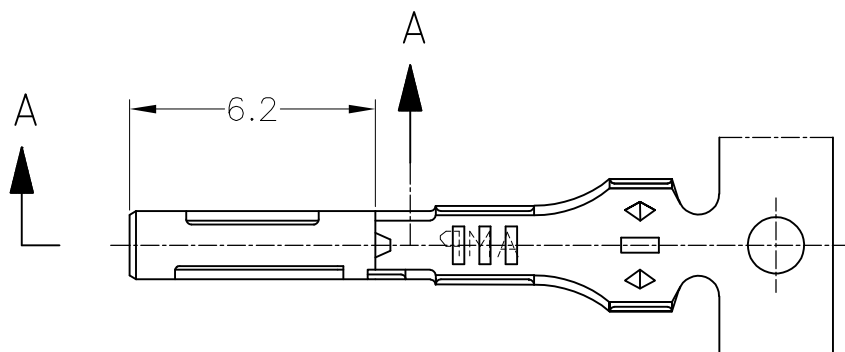

I.D. OF GOLD PLATED
金めっき表示位置

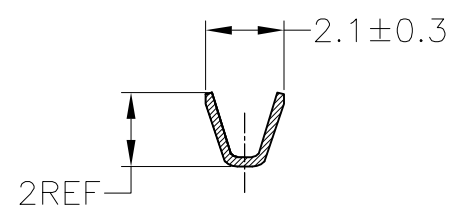

B-B

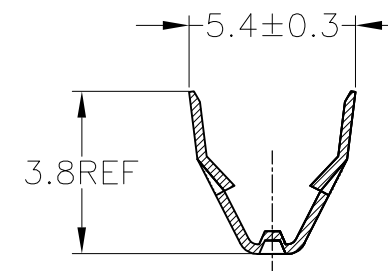

C-C

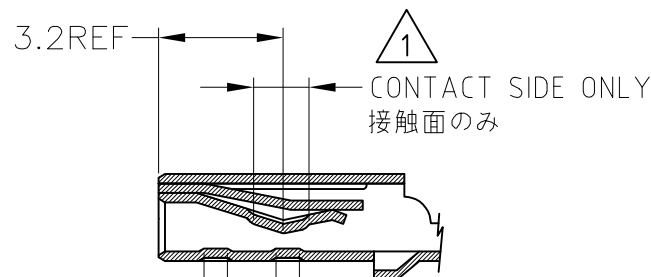

CONTACT SIDE ONLY
接触面のみ

A-A

TOLERANCES UNLESS OTHERWISE SPECIFIED:

一般公差	
10 ≥	±0.2
30 ≥ > 10	±0.25
100 ≥ > 30	±0.3
ANGLE	±3°

THIS DRAWING IS A CONTROLLED DOCUMENT.

DIMENSIONS:
単位： 耗
mm

TOLERANCES UNLESS OTHERWISE SPECIFIED:
一般公差

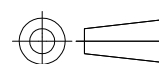

MATERIAL
材料
PHOS. BRONZE, THK 0.25
りん青銅、板厚；0.25

FINISH
仕上
SEE TABLE

DWN T.SHINOHARA 25MAY04

CHK K.BETSUI 25MAY04

APVD K.BETSUI 25MAY04

PRODUCT SPEC
製品規格

APPLICATION SPEC
取付適用規格

WEIGHT 0.262

CUSTOMER DRAWING

SEE DRAWING 173681-6	173681-6	
175062-2	SELECTIVE GOLD	173681-2
175062-1	PRE-TINNED	173681-1
LOOSE PIECES NUMBER	FINISH	PART NUMBER
WIRE RANGE (抱合電線断面積) 0.3~0.56mm ² (AWG#22~20)		INSULATION DIA. (被覆外径) 1.8~2 mmφ

STE TE Connectivity

040 SERIES RECEPTACLE CONTACT

NAME 名称	RESTRICTED TO				
SIZE A3	CAGE CODE 00779	DRAWING NO 番号 C-173681	SCALE 尺度 5:1	SHEET 1 OF 1	REV E4