

KEMET Part Number: C0402C332K5RACTU
(C0402C332K5RAC7867)

SMD Comm X7R, Ceramic, 3300 pF, 10%, 50 VDC, X7R, SMD, MLCC, Temperature Stable, Class II, 0402

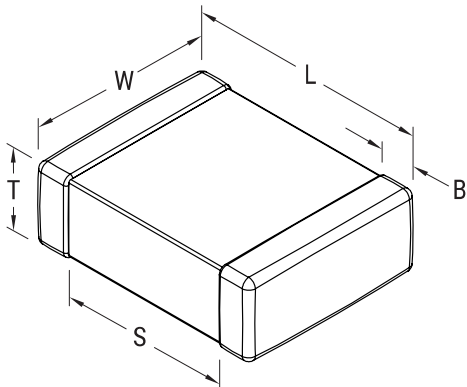

Dimensions

Dimension	Value
L	1mm +/-0.05mm
W	0.5mm +/-0.05mm
T	0.5mm +/-0.05mm
S	0.3mm MIN
B	0.3mm +/-0.1mm

Packaging Specifications

Packaging:	T&R, 180mm, Paper Tape
Packaging Quantity:	10000

General Information

Supplier:	KEMET
Series:	SMD Comm X7R
Style:	SMD Chip
Description:	SMD, MLCC, Temperature Stable, Class II
Features:	Temperature Stable, Class II
RoHS:	Yes
Termination:	Tin
Marking:	No
Miscellaneous:	Note: Referee time for X7R dielectric for this part number is 1000 hours
Chip Size:	0402
Shelf Life:	78 Weeks
MSL:	1

Specifications

Capacitance:	3300 pF
Capacitance Tolerance:	10%
Voltage DC:	50 VDC
Dielectric Withstanding Voltage:	125 VDC
Temperature Range:	-55/+125°C
Temperature Coefficient:	X7R
Dissipation Factor:	2.50% 1kHz 25C
Aging Rate:	3% Loss/Decade Hour
Insulation Resistance:	100 GOhms