

Ty-Rap®

Fastening solutions, how it all started



When you choose a Ty-Rap® cable tie, you can count on quality, performance and innovation to make your work easier.

First developed to solve the problem of bundling the hundreds of feet of wiring found inside commercial aircraft, Ty-Rap® cable ties can now be found virtually everywhere - from Nascar racing engines to backyard tool sheds. Self-fastening and basically indestructible, the ground-breaking design of the Ty-Rap® cable tie demonstrates how to solve a complex problem with a simple technology.

The corrosion-proof, non-magnetic stainless steel locking device inside the tie head guarantees the strongest and most durable locking you will ever find on the market. Ty-Rap® can be used in the most adverse conditions: humidity, heat, cold, UV radiation, aggressive chemicals, radiation and other harsh conditions.

Engineered for labour savings and high performance, Ty-Rap® cable ties are commonly used in a variety of applications.



“My dad didn’t have a lot of formal education, but he was the most ingenious person I have ever met,» said Robert Logan, Maurus’ son. «He never thought the customary way of doing things was good enough and when he looked at anything he thought about ways to improve it. The invention of the cable tie is an excellent example of how he worked.»

Maurus Logan Ty-Rap® Inventor

For the cable tie, the proverbial light bulb came on over Logan’s head while touring a Boeing aircraft manufacturing facility in 1956. Aircraft wiring was a cumbersome and detailed undertaking, involving thousands of feet of wire organized on sheets of 50-foot long plywood and held in place with knotted, wax-coated, braided nylon cord. Each knot had to be pulled tight by wrapping the cord around one’s finger which sometimes cut the operator’s fingers until they developed thick calluses or

«hamburger hands.» Logan was convinced there had to be an easier, more forgiving, way to accomplish this critical task. For the next couple of years, Logan experimented with various tools and materials.

On June 24, 1958, a patent for the longlasting, easy-to-use Ty-Rap® cable tie was submitted. The rest, as they say, is history.



Table of Content

Ty-Rap® High Performance Cable Ties

Ty-Rap® High Performance Cable Ties	2
Features & Benefits	6
Ty-Rap® High Performance Cable Ties	8
Product reference structure	8
Polyamide 6.6 cable ties - Natural	9
Polyamide 6.6 cable ties - UV-resistant black	10
Polyamide 6.6 cable ties - Coloured	11
Polyamide 6.6 cable ties - Natural - Euroslot packaging	12
Polyamide 6.6 cable ties - UV-resistant black - Euroslot packaging	13
Polyamide 6.6 cable ties - Workbench boxes	14
Polyamide 6.6 cable ties - Multi-coloured - UV-resistant	15
Printed cable ties	15
Ty-Rap® Professional Kit, Ty-Rap® Dispenser	16
Polyamide 6.6 cable ties - Flame retardant	17
Polyamide 6.6 cable ties - Heat stabilised	18
Polyamide 6.6 cable ties - Heat stabilised + UV-resistant	19
Polyamide 4.6 cable ties - Extra high temperature	20
Polyamide 12 cable ties - UV-resistant	21
Polypropylene cable ties - Weatherable	22
Detectable cable ties	23
Fluoropolymer cable ties - ECTFE	24
Fluoropolymer cable ties - ETFE	25
Special ties with steel locking barb	26
Integrated mounting hole cable ties	26
Panel mounting cable ties	27
Blind mounting cable ties	28
Integrated peg / nail cable ties	30
Releasable cable ties	31
Cable ties with identification tag	35
Identification tags	37
Cable support system with metallic locking barb	38
Pre-assembled Deltec® cable ties	38
Strap on reel, Double locking heads	39
Deltec® Kits, Cable spacers	40
Base and hanger	41
Ty-Fast® All-plastic cable ties	42
Ty-Met™ Stainless steel cable ties	66
Mounting bases and accessories	84
Cable protection systems	120
Cable tie tooling	130
Material specifications	144

Introduction
Ty-Rap® High Performance Cable Ties



Ty-Rap®

High Performance Cable Ties

Thomas & Betts (today a Member of the ABB Group) invented the Ty-Rap® cable tie to solve the problem of harnessing the hundreds of wires used in manufacturing aircraft and revolutionised the world of fastening. Today, the Ty-Rap® brand remains the benchmark for excellence and innovation in wire management.

Ty-Rap®

ABB's broad offering of cable ties is designed to make the task of fastening, bundling, clamping and managing wires easier and quicker for industrial applications, construction, communications, utility and OEM professionals as well as home improvement specialists and do-it-yourself enthusiasts. When strength, aesthetics, reliability and performance are required, knowledgeable professionals turn to the original and the best source for cable ties and accessories.

The corrosion-proof, non-magnetic stainless steel locking device inside the tie head guarantees the strongest and most durable locking you will ever find on the market. Ty-Rap® can be used in the most adverse conditions: humidity, heat, cold,...

Engineered for labour savings and high performance, Ty-Rap® cable ties are commonly used in a variety of applications.

When you choose a Ty-Rap® cable tie, you can count on quality, performance and innovation to make your work easier.

Thomas & Betts - A Member of the ABB Group

Since June 2012, Thomas & Betts (T&B) is a Member of the ABB Group. ABB is a leading power and automation technology group, active in more than 100 countries with about 150.000 employees worldwide.

With Thomas & Betts, this portfolio will now be completed with the following product lines and flagship brands:

- *Wire & Cable Management* - Ty-Rap® and Ty-Met® cable ties, Shrink-Kon® heat shrink, T&B Cabletray
- *Cable Protection Systems* - nylon & metallic incl. brands: PMA, Adaptaflex, Kopex, Harnessflex
- *Low Power Connection & Control* - Furse lightning & surge protection, Elastimold, Joslyn Hi-Voltage
- *Emergency lighting* - emergency lighting, battery systems incl. VanLien, Kaufel, Emergi-Lite brands
- *Hazardous location products* - DTS explosion proof light & boxes, Kopex-Ex conduits & fittings

Ty-Rap® High Performance Cable Ties

Features and Benefits

When strength, aesthetics, reliability and performance are required, knowledgeable professionals turn to the original and the best source for cable ties and accessories. Ty-Rap® fastening systems include a full range of cable ties, identification ties, clamps, mounting bases, harnessing aids and installing tools. Using Ty-Rap® fastening systems for all wiring jobs, large and small, will speed and improve the reliability of harnessing and wire bundling while saving you money.

Ty-Rap®

Rounded Edges, on the head and the strap, provide a comfortable handling of the ties and prevent sharp edges from damaging the cables. This gradual transition from the strap to the head protects the material against breaking at this most critical point. The edges of the head are also rounded off to offer maximum protection from injury.

Smooth, Notchless Body, reduces stress concentration points, making the Ty-Rap® ties stronger and thinner than conventional ties with notched bodies. The low-profile design of the head allows secure tying in tight spaces. No serration, means infinite adjustment (tensioned right every time).

Ribbed and Stippled Surface, to prevent the tie from slipping around and along the bundle under vibration conditions and external shock.

“The Grip of Steel”

Non-Magnetic Stainless Steel Locking Barb – marine grade type 316 - that firmly anchors inside the tie head, ensures a strong, reliable and long lasting fastening under adverse conditions.

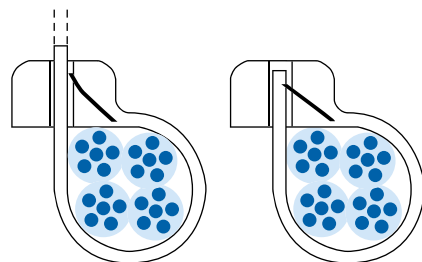

Non-Slip Tail, for an easy grip and pulling through the head during tensioning.

Extensive range of approvals and certifications: Germanischer Lloyd, Lloyd's Register of Shipping, VG, Mil Specification, American Bureau of Shipping (ABS); CE declaration, compliant to the low voltage directive and EN/IEC 62275 and UL 62275



Wide Range of Size Combinations: several lengths up to 1143 mm, in 6 typical widths with a tensile strength up to 780N, to fasten cable bundles with a diameter up to 330mm.

Dedicated Tooling, to ensure that the excess end of the Ty-Rap® tie is automatically cut off and the slight over cut retracts into the head, eliminating the risk of injury from protruding sharp edges.

Most Extensive Choice of Special Materials: in addition to Polyamide 6.6 (standard, UV-resistant, heat stabilised, flame retardant, heat stabilised / UV-resistant), Polyamide 4.6 (extra high temperature) and Polyamide 12, the Ty-Rap® ties are available in Polypropylene, Fluoropolymer (ECTFE), Fluoropolymer (ETFE) and the recently introduced Detectable Polyamide 6.6 and Detectable Polypropylene. UL 94 V-0, UL 94 V-2 and UL 94 HB.

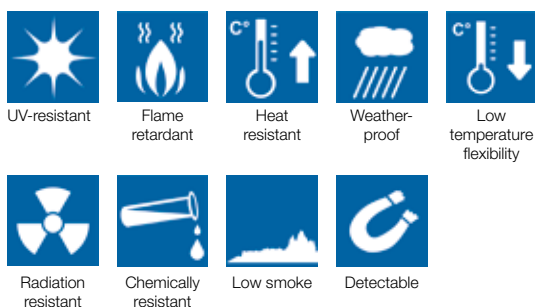

Angled Tail (turned up) for fast and easy insertion into the locking head and ideally suited to being picked up from a flat work area.

Wide Choice of Colours: 10 standard colours are available and pre-printed customized ties in any of the standard colours can be supplied on demand.



Different Types of Packaging, including the unique "workbench boxes" for fast working without problems or losses. Recyclable packaging for a better contribution to the environment.

Outstanding Range of Special Ties, all with the famous stainless steel locking device: ties with mounting hole or integrated peg/nail, panel mounting ties, identification ties with integrated label,...

Broad Range of Mounting Bases and Accessories.

Ty-Rap® High Performance Cable Ties

Product reference structure

Ty-Rap® code

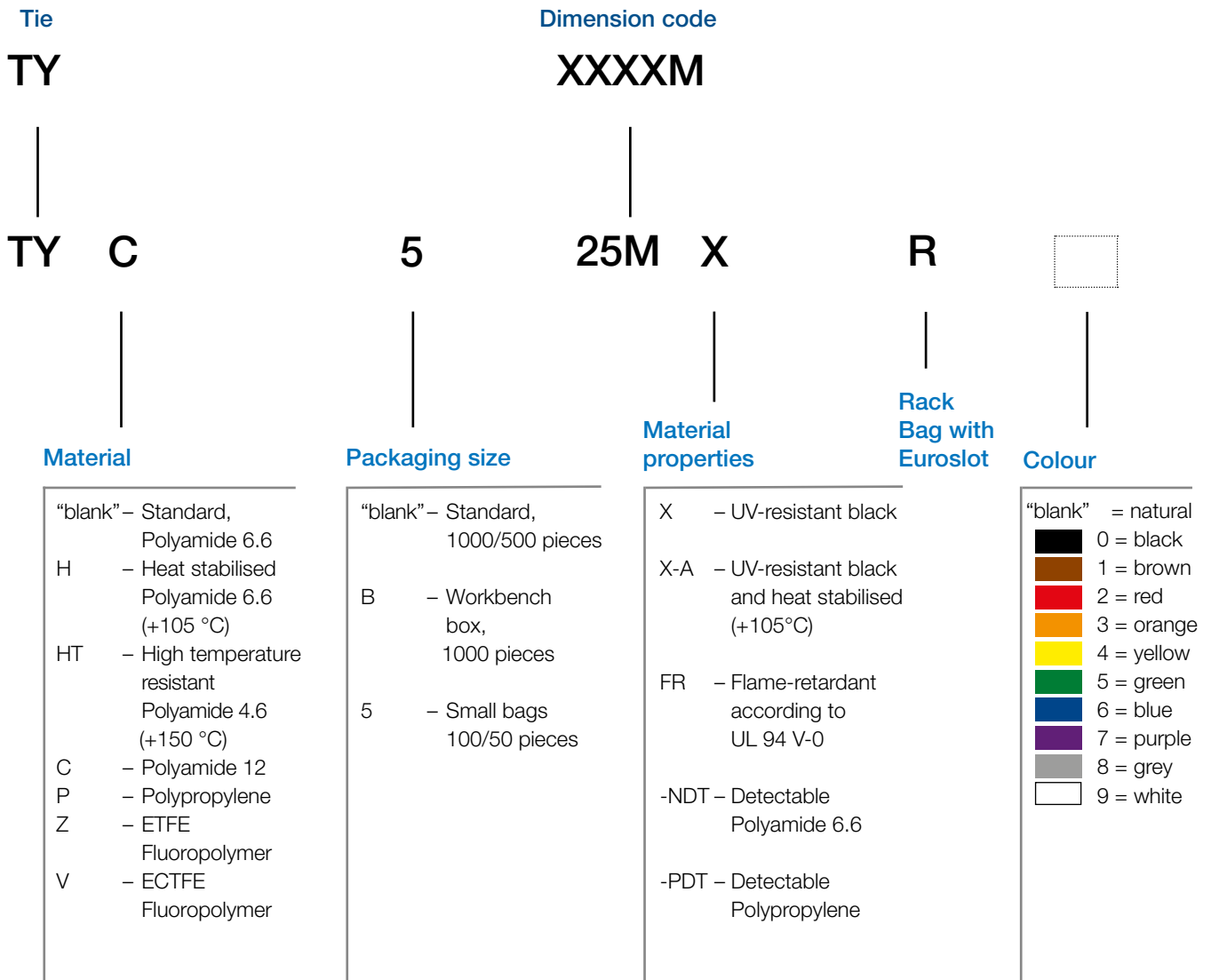

Note: Nylon (Polyamide) is inherently susceptible to environmental conditions. Ty-Rap® cable ties are moisturised to optimum performance levels at machine-side and should be stored in cool dry areas out of direct sunlight. Cable ties are packaged in plastic bags to contain moisture and should remain sealed until ready for use.

Ty-Rap® High Performance Cable Ties

Polyamide 6.6 cable ties – Natural

Characteristics

- Standard version (Polyamide 6.6), to cover most indoor applications
- Several lengths and 6 typical widths with a tensile strength up to 780N, to cover the most demanding applications
- Packaging: OEM bulk quantities in recyclable polythene bags
- Also available in small bags with Euroslot (see page 12) and in workbench boxes (see page 14)

Technical Information

Material - Moulding	Polyamide 6.6
Material - Locking barb	316 grade stainless steel
Temperature range	-60°C to +85°C
Min. Installation Temp.	-20°C
Colour	Natural
Flammability rating	UL 94 V-2
Other properties	Halogen free, Silicone free



Product Ref.	MIL Spec.	Length	Width	Thickness	Bundle ø from ... to [mm]	Min. tensile strength [N]	Quantity [pieces]	Tooling	
		L [mm]	W [mm]	[mm]					
TY23M	MS-3367-4	92	2.3	1.0	1.5 - 22	80	1000	ERG50	
TYB2315M	-	178	2.3	1.0	1.5 - 32	80	1000		
TY232M	-	203	2.3	1.0	1.5 - 51	80	1000		
TY234M	-	356	2.3	1.0	1.5 - 102	80	1000		
TY24M	MS-3367-5	140	3.6	1.1	2 - 35	178	1000		
TY242M	-	208	3.6	1.1	2 - 51	180	1000		
TY26M	-	284	3.6	1.1	2 - 76	130	1000		
TY244M	-	368	3.6	1.1	2 - 102	134	1000		
TY25M	MS-3367-1	186	4.8	1.1	3 - 48	222	1000		ERG50 ERG120
TY253M	MS-3367-7	290	4.8	1.3	3 - 78	222	1000		
TY28M	MS-3367-2	361	4.8	1.3	3 - 102	222	1000	ERG120 L-500-EU	
TY271M	-	150	7.0	1.6	6 - 31	540	500		
TY272M	-	223	6.9	1.6	6 - 51	534	500		
TY27M	MS-3367-3	340	7.0	1.6	6 - 102	540	500		
TY275M	-	457	7.0	1.6	6 - 127	540	500		
TY277M	-	617	7.0	1.6	6 - 177	540	500		
TY29M	MS-3367-6	771	6.9	1.5	6 - 229	540	500	WT3D L-500-EU	
TY53510M	-	889	8.2	1.7	to 254	780	50		
TY54513M	-	1143	8.2	1.7	to 330	780	50		

Description of product reference structure: see page 8

Description of materials and properties: see pages 144 to 155

For tooling specifications: see pages 130 to 143

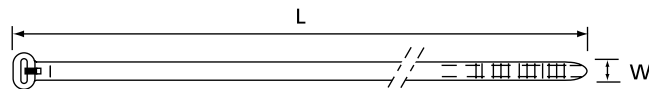

E49405



* Some approvals may not be applicable to all the Product References. Contact your Sales Office for approvals limitations

Ty-Rap® High Performance Cable Ties

Polyamide 6.6 cable ties – UV-resistant black

Characteristics

- UV-resistant version, especially recommended for outdoor applications
- Black version (2% carbon for military specifications)
- Also available in heat stabilised + UV-resistant version (contains 2% carbon according to military application), for outdoor applications that also require a resistance to high temperature (+105 °C). See page 19 (TY...MX-A series)
- Several lengths and 6 typical widths with a tensile strength up to 780N, to cover the most demanding applications
- Packaging: OEM bulk quantities in recyclable polythene bags
- Also available in small bags with Euroslot (see page 12) and in workbench boxes (see page 14)

Technical Information

Material - Moulding	Polyamide 6.6
Material - Locking barb	316 grade stainless steel
Temperature range	-60°C to +105°C
Min. Installation Temp.	-30°C
Colour	Black
Flammability rating	UL 94 V-2
Other properties	UV-resistant, Halogen free, Silicone free



Product Ref.	MIL Spec.	Length L [mm]	Width W [mm]	Thickness [mm]	Bundle ø from ... to [mm]	Min. tensile strenght [N]	Quantity [pieces]	Tooling
TY23MX	MS-3367-4	92	2.3	1.0	1.5 - 22	80	1000	ERG50
TYB2315MX	-	178	2.3	1.0	1.5 - 32	80	1000	
TY232MX	-	203	2.3	1.0	1.5 - 51	80	1000	
TY234MX	-	356	2.3	1.0	1.5 - 102	80	1000	
TY24MX	MS-3367-5	140	3.6	1.1	2 - 35	180	1000	
TY242MX	-	208	3.6	1.1	2 - 51	180	1000	
TY26MX	-	284	3.6	1.1	2 - 76	130	1000	ERG50 ERG120
TY244MX	-	368	3.6	1.1	2 - 102	130	1000	
TY25MX	MS-3367-1	186	4.8	1.1	3 - 48	220	1000	
TY253MX	MS-3367-7	290	4.8	1.3	3 - 78	222	1000	
TY28MX	MS-3367-2	361	4.8	1.3	3 - 102	222	1000	
TY271MX	-	150	7.0	1.6	6 - 31	540	500	
TY272MX*	-	223	6.9	1.6	6 - 51	540	500	ERG120 L-500-EU
TY27MX*	MS-3367-3	340	7.0	1.6	6 - 102	540	500	
TY275MX*	-	457	7.0	1.6	6 - 127	540	500	
TY277MX*	-	617	7.0	1.6	6 - 177	540	500	
TY29MX*	MS-3367-6	771	6.9	1.5	6 - 229	540	500	WT3D L-500-EU
TY53510MX	-	889	8.2	1.7	to 254	780	50	
TY54513MX	-	1143	8.2	1.7	to 330	780	50	

* Min. installation temp : -40°C

Description of product reference structure: see page 8

Description of materials and properties: see pages 144 to 155

For tooling specifications: see pages 130 to 143

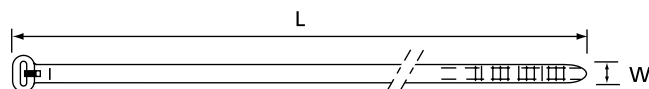

* Some approvals may not be applicable to all the Product References. Contact your Sales Office for approvals limitations

Ty-Rap® High Performance Cable Ties

Polyamide 6.6 cable ties – Coloured

Characteristics

Ty-Rap® ties in Polyamide 6.6 are available in 10 different colours and pre-printed ties in any of the standard colours can be supplied on demand.

- Several lengths and 6 typical widths with a tensile strength up to 780 N, to cover the most demanding applications
- Standard packaging is 1.000 / 500 pieces but smaller packaging (100 pieces) can also be supplied on request
- Please contact your Sales Office for product availability and Minimum Order Quantity

Technical Information

Material - Moulding	Polyamide 6.6
Material - Locking barb	316 grade stainless steel
Temperature range	-60°C to +85°C
Min. Installation Temp.	-20°C
Flammability rating	UL 94 V-2
Other properties	Halogen free, Silicone free



Product Ref.	MIL Spec.	Length L [mm]	Width W [mm]	Thickness [mm]	Bundle ø from ... to [mm]	Min. tensile strenght [N]	Quantity ** [pieces]	Tooling
TY23M-*	MS-3367-4	92	2,3	1,0	1,5 - 22	80	1000	ERG50
TY232M-*	-	203	2,3	1,0	1,5 - 51	80	1000	
TY234M-*	-	356	2,3	1,0	1,5 - 102	80	1000	
TY24M-*	MS-3367-5	140	3,6	1,1	2 - 35	180	1000	
TY242M-*	-	208	3,6	1,1	2 - 51	180	1000	
TY26M-*	-	284	3,6	1,1	2 - 76	130	1000	ERG50 ERG120
TY244M-*	-	368	3,6	1,1	2 - 102	134	1000	
TY25M-*	MS-3367-1	186	4,8	1,1	3 - 48	222	1000	
TY253M-*	MS-3367-7	290	4,8	1,3	3 - 78	222	1000	
TY28M-*	MS-3367-2	361	4,8	1,3	3 - 102	222	1000	
TY271M-*	-	150	7,0	1,6	6 - 31	540	500	ERG120 L-500-EU
TY272M-*	-	223	6,9	1,6	6 - 51	540	500	
TY27M-*	MS-3367-3	340	7,0	1,6	6 - 102	540	500	
TY275M-*	-	457	7,0	1,6	6 - 127	540	500	
TY277M-*	-	617	7,0	1,6	6 - 177	540	500	
TY29M-*	MS-3367-6	771	6,9	1,5	6 - 229	540	500	WT3D L-500-EU
TY53510M-*	-	889	8,2	1,7	to 254	780	50	
TY54513M-*	-	1143	8,2	1,7	to 330	780	50	

For cable ties in a specific colour, replace * in the Product Reference by the colour code:
0 = black, 1 = brown, 2 = red, 3 = orange, 4 = yellow, 5 = green, 6 = blue, 7 = purple, 8 = grey and 9 = white



For example: TY23M-1 defines a brown TY23M cable tie. Contact your Sales Office for product availability.

** For smaller quantities, the figure "5" needs to be added to the part number immediately after "TY" -
example: TY523M-2 is the same as TY23M-2 but in bags of 100

Description of product reference structure: see page 8
Description of materials and properties: see pages 144 to 155
For tooling specifications: see pages 130 to 143

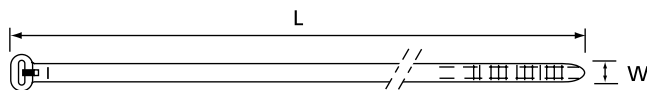

E49405



*** Some approvals may not be applicable to all the Product References. Contact your Sales Office for approvals limitations

Ty-Rap® High Performance Cable Ties

Polyamide 6.6 cable ties – Natural – Euroslot packaging

Characteristics

The main characteristics of the Ty-Rap® cable ties are shown on pages 6 and 7.

- Standard version (Polyamide 6.6), to cover most indoor applications
- Packaging in small polythene bags with Euroslot, ideal for display and point-of-sales promotion (rack)
- Several lengths and 5 typical widths with a tensile strength up to 540N, to cover the most demanding applications
- Very convenient for small series production: 100 pieces (for cable ties from 2.3 mm to 4.8 mm width) or 50 pieces (for cable ties 6.9 mm width and above)

Technical Information

Material - Moulding	Polyamide 6.6
Material - Locking barb	316 grade stainless steel
Temperature range	-60°C to +85°C
Min. Installation Temp.	-20°C
Colour	Natural
Flammability rating	UL 94 V-2
Other properties	Halogen free, Silicone free



Product Ref.	MIL Spec.	Length L [mm]	Width W [mm]	Thickness [mm]	Bundle ø from ... to [mm]	Min. tensile strenght [N]	Quantity [pieces]	Tooling
TY523MR	MS-3367-4	92	2.3	1.0	1.5 - 22	80	100	ERG50
TY5232MR	-	203	2.3	1.0	1.5 - 51	80	100	
TY5234M	-	356	2.3	1.0	1.5 - 102	80	100	
TY524MR	MS-3367-5	140	3.6	1.1	2 - 35	178	100	
TY5242MR	-	208	3.6	1.1	2 - 51	180	100	
TY526MR	-	284	3.6	1.1	2 - 76	130	100	
TY5244MR	-	368	3.6	1.1	2 - 102	134	100	
TY525MR	MS-3367-1	186	4.8	1.1	3 - 48	222	100	ERG50 ERG120
TY5253MR	MS-3367-7	290	4.8	1.3	3 - 78	222	100	
TY528MR	MS-3367-2	361	4.8	1.3	3 - 102	222	100	
TY5271MR	-	150	7.0	1.6	6 - 31	540	50	ERG120 L-500-EU
TY5272MR	-	223	6.9	1.6	6 - 51	534	50	
TY527MR	MS-3367-3	340	7.0	1.6	6 - 102	540	50	
TY5275M	-	457	7.0	1.6	6 - 127	540	50	
TY5277M	-	617	7.0	1.6	6 - 177	540	50	
TY529M	MS-3367-6	771	6.9	1.5	6 - 229	540	50	

Product References TY5234M, TY5275M, TY5277M and TY529M have no Euroslot

Description of product reference structure: see page 8

Description of materials and properties: see pages 144 to 155

For tooling specifications: see pages 130 to 143

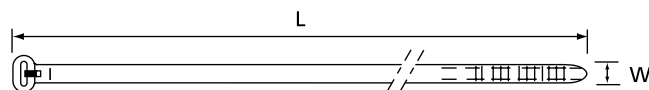

E49405



* Some approvals may not be applicable to all the Product References. Contact your Sales Office for approvals limitations

Ty-Rap® High Performance Cable Ties

Polyamide 6.6 cable ties – UV-resistant black – Euroslot packaging

Characteristics

The main characteristics of the Ty-Rap® cable ties are shown on pages 6 and 7.

- UV-resistant version, especially recommended for outdoor applications
- Black version (2% carbon for military specifications)
- Packaging in small polythene bags with Euroslot, ideal for display and point-of-sales promotion (rack)
- Several lengths and 5 typical widths with a tensile strength up to 540N, to cover the most demanding applications
- Very convenient for small series production: 100 pieces (for cable ties from 2.3 mm to 4.8 mm width) or 50 pieces (for cable ties 6.9 mm width and above)

Technical Information

Material - Moulding	Polyamide 6.6
Material - Locking barb	316 grade stainless steel
Temperature range	-60°C to +105°C
Min. Installation Temp.	-30°C
Colour	Black (other colours see page 15)
Flammability rating	UL 94 V-2
Other properties	Halogen free, Silicone free



Product Ref.	MIL Spec.	Length L [mm]	Width W [mm]	Thickness [mm]	Bundle ø from ... to [mm]	Min. tensile strenght [N]	Quantity [pieces]	Tooling
TY523MXR	MS-3367-4	92	2.3	1.0	1.5 - 22	80	100	ERG50
TY5232MXR	-	203	2.3	1.0	1.5 - 51	80	100	
TY5234MX*	-	356	2.3	1.0	1.5 - 102	80	100	
TY524MXR	MS-3367-5	140	3.6	1.1	2 - 35	180	100	
TY5242MXR	-	208	3.6	1.1	2 - 51	180	100	
TY526MXR	-	284	3.6	1.1	2 - 76	130	100	
TY5244MXR	-	368	3.6	1.1	2 - 102	130	100	ERG50 ERG120
TY525MXR	MS-3367-1	186	4.8	1.1	3 - 48	220	100	
TY5253MXR	MS-3367-7	290	4.8	1.3	3 - 78	222	100	
TY528MXR	MS-3367-2	361	4.8	1.3	3 - 102	222	100	ERG120 L-500-EU
TY5271MXR	-	150	6.9	1.6	6 - 31	540	50	
TY5272MXR*	-	223	6.9	1.6	6 - 51	540	50	
TY527MXR*	MS-3367-3	340	7.0	1.6	6 - 102	540	50	
TY5275MX*	-	457	7.0	1.6	6 - 127	540	50	
TY5277MX*	-	617	6.9	1.6	6 - 177	540	50	
TY529MX*	MS-3367-6	771	6.9	1.6	6 - 229	540	50	

* Min. installation temp : -40°C

Product References TY5234MX, TY5275MX, TY5277MX and TY529MX have no Euroslot

Description of product reference structure: see page 8

Description of materials and properties: see pages 144 to 155

For tooling specifications: see pages 130 to 143

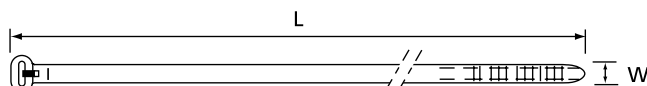

E49405



** Some approvals may not be applicable to all the Product References. Contact your Sales Office for approvals limitations

Ty-Rap® High Performance Cable Ties

Polyamide 6.6 cable ties – Workbench boxes

Characteristics

- An attractive packaging option for high volume manual assembly: 1000 pieces in a workbench box - easy to reach, hence timesaving
- This user-friendly packaging allows fast working without problems or losses

Technical Information

Material - Moulding	Polyamide 6.6
Material - Locking barb	316 grade stainless steel
Temperature range	-60°C to +85°C (natural) -60°C to +105°C (black)
Min. Installation Temp.	-20°C (natural) -30°C (black)
Colour	Natural or UV-resistant black (other colours see page 15)
Flammability rating	UL 94 V-2
Other properties	Halogen free, Silicone free, UV-resistant (black)



Product Ref.	MIL Spec.	Colour	Length	Width	Thick-ness	Bundle ø from ... to	Min. tensile strenght	Quantity	Tooling
			L [mm]	W [mm]					
TYB23M	MS-3367-4	natural	92	2.3	1.0	1.5 - 22	80	1000	ERG50
TYB23MX	MS-3367-4	UV-resistant black	92	2.3	1.0	1.5 - 22	80	1000	
TYB232M	-	natural	203	2.3	1.0	1.5 - 51	80	1000	
TYB232MX	-	UV-resistant black	203	2.3	1.0	1.5 - 51	80	1000	
TYB24M	MS-3367-5	natural	140	3.6	1.1	2 - 35	178	1000	ERG50
TYB24MX	MS-3367-5	UV-resistant black	140	3.6	1.1	2 - 35	180	1000	
TYB25M	MS-3367-1	natural	186	4.8	1.3	3 - 48	222	1000	ERG120
TYB25MX	MS-3367-1	UV-resistant black	186	4.8	1.3	3 - 48	220	1000	

Description of product reference structure: see page 8

Description of materials and properties: see pages 144 to 155

For tooling specifications: see pages 130 to 143

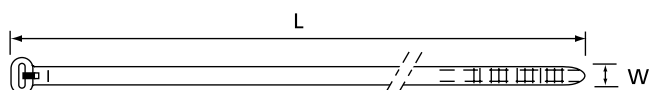

E49405



* Some approvals may not be applicable to all the Product References. Contact your Sales Office for approvals limitations

Ty-Rap® High Performance Cable Ties

Polyamide 6.6 cable ties – Multi-coloured

Characteristics

- Multi-coloured TY25M cable ties in a single, convenient package
- Supplied in bags of 100 ties containing ten ties of each of the 10 standard colours (TY25M-0 to TY25M-9)
- Ideal for applications which require a colour coding or which have an aesthetic sensitivity (to match the colour of the cable or of the support), especially in cable bundling in telecom, datacom, cable and satellite TV

Technical Information

Material - Moulding	Polyamide 6.6
Material - Locking barb	316 grade stainless steel
Temperature range	-60°C to +85°C
Min. Installation Temp.	-20°C
Colour	Black, brown, red, orange, yellow, green, blue, purple, grey, white (10 ties of each colour)
Flammability rating	UL 94 V-2
Other properties	Halogen free, Silicone free



Product Ref.	Length L [mm]	Width W [mm]	Thickness [mm]	Bundle ø from ... to [mm]	Min. tensile strenght [N]	Quantity [pieces]	Tooling
TY525M-CLRS	186	4.8	1.1	3 - 48	222	100	ERG50, ERG120

Description of product reference structure: see page 8
 Description of materials and properties: see pages 144 to 155
 For tooling specifications: see pages 130 to 143

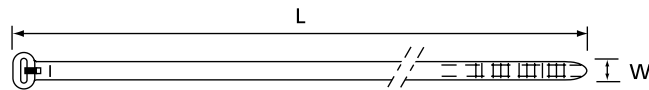

Ty-Rap® High Performance Cable Ties

Printed cable ties



ABB extends its highly respected existing capabilities in cable tie manufacture with its in-house printing equipment in order to respond flexibly to customer requirements and to allow rapid delivery. This service is offered for ties having a width of minimum 4.6 mm (batches of minimum 5,000 ties approximately)

According to the requirements, following printing processes are proposed:

Hot foil transfer

- The print is highly durable
- The basic character set is in accordance with DIN1451 - (3 mm character height)
- Text colours: Red, Orange, Yellow, Bright-Yellow, Green, Blue, Brown, Dark-Brown, Black, White

Laser printing

- The print is highly durable
- The standard printing colour is black
- The print is wear and weather resistant

Please contact your Sales Office for other character sets and special stamping designs.

Ty-Rap® High Performance Cable Ties

Ty-Rap® professional kit



Product Ref.: TYRAP PROF KIT

Characteristics

A handy kit containing a professional selection of Ty-Rap® fastening products in one convenient box

- One ergonomic fastening tool ERG50 with exclusive features for quick set-up and fast installation
- 500 Ty-Rap® cable ties TY525MR
- 500 UV-resistant Ty-Rap® cable ties TY525MXR
- Includes a handy, light weight re-usable dispenser (Ty-Tote-25)

Ty-Rap® dispenser



Characteristics

- Save time by using the Ty-Rap® cable tie dispenser

Technical Information

- Durable, lightweight polyester exterior and tough vinyl interior construction
- Rugged diamond-shaped cutout for easy access to cable ties (up to 203 mm, 280 mm – 356 mm) and rectangular-shaped (for 102 mm)
- Handy belt clip and chrome steel loop for easy attachment
- Resealable hook-and-loop for easy refill
- Includes 100 genuine Ty-Rap® cable ties

Product Ref.	Description
TY-TOTE-23	Ty-Rap® Tote® 102mm Cable Tie Dispenser (includes 1 package TY523M)
TY-TOTE-25	Ty-Rap® Tote® 203mm Cable Tie Dispenser (includes 1 package TY525M)

Ty-Rap® High Performance Cable Ties

Polyamide 6.6 cable ties – Flame retardant

Characteristics

- Flame retardant version. Ideal for use when low flammability and low smoke are necessary such as public transport, tunnels, etc.

Technical Information

Material - Moulding	Polyamide 6.6
Material - Locking barb	316 grade stainless steel
Temperature range	-40°C to +65°C
Min. Installation Temp.	-0°C
Colour	White
Flammability rating	UL 94 V-2
Other properties	Halogen free, Silicone free



Product Ref.	Length L [mm]	Width W [mm]	Thickness [mm]	Bundle ø from ... to [mm]	Min. tensile strenght [N]	Quantity [pieces]	Tooling
TY23MFR	92	2.4	1.0	1.5 - 22	80	1000	
TY232MFR	203	2.4	1.0	1.5 - 51	80	1000	ERG 50
TY24MFR	140	3.6	1.1	2 - 35	134	1000	
TY25MFR	186	4.6	1.1	3 - 48	220	1000	ERG50
TY28MFR	360	4.6	1.1	3 - 102	177	500	ERG120
TY27MFR	335	7.6	1.6	6 - 95	540	500	ERG120
TY272MFR	223	7.0	1.6	4.8 - 51	540	500	L-500-EU

Description of product reference structure: see page 8
 Description of materials and properties: see pages 144 to 155
 For tooling specifications: see pages 130 to 143

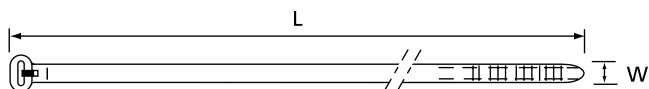

E49405



Ty-Rap® High Performance Cable Ties

Polyamide 6.6 cable ties – Heat stabilised

Characteristics

- Heat stabilised version, for applications up to 105°C.

Technical Information

Material - Moulding	Polyamide 6.6
Material - Locking barb	316 grade stainless steel
Temperature range	-60°C to +105°C
Min. Installation Temp.	-30°C
Colour	Natural (may have a greenish tint)
Flammability rating	UL 94 V-2
Other properties	Halogen free, Silicone free



Product Ref.	Length L [mm]	Width W [mm]	Thickness [mm]	Bundle ø from ... to [mm]	Min. tensile strenght [N]	Quantity [pieces]	Tooling
TYH23M / TYHB23M	92	2.4	1.0	1.5 - 22	80	1000	ERG50
TYH232M	203	2.4	1.0	1.5 - 51	80	1000	
TYH24M	140	3.6	1.1	2 - 35	180	1000	
TYH242M*	208	3.6	1.1	2 - 51	180	1000	
TYH26M	284	3.6	1.1	2 - 76	130	1000	
TYH25M	186	4.7	1.3	3 - 48	220	1000	ERG50 ERG120
TYH253M*	290	4.8	1.2	3 - 76	220	1000	
TYH28M	360	4.8	1.3	3 - 102	220	1000	L-500-EU ERG120
TYH272M*	222	7.6	1.6	4.8 - 51	540	500	
TYH27M	340	7.0	1.6	4.8 - 102	540	500	
TYH29M*	771	6.9	1.5	4.8 - 229	540	500	

* Not UL recognised

Description of product reference structure: see page 8
 Description of materials and properties: see pages 144 to 155
 For tooling specifications: see pages 130 to 143

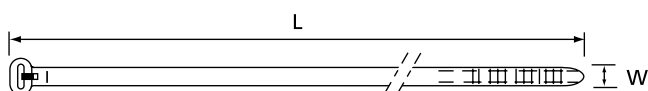

E49405



Ty-Rap® High Performance Cable Ties

Polyamide 6.6 cable ties – Heat stabilised + UV-resistant

Characteristics

- Heat stabilised + UV-resistant version, for outdoor applications that also require a resistance to high temperature (+105°C)
- For OEM and MRO applications like: transportation, lawn (garden / farm), construction equipment, recreational vehicles

Technical Information

Material - Moulding	Polyamide 6.6
Material - Locking barb	316 grade stainless steel
Temperature range	-60°C to +105°C
Min. Installation Temp.	-40°C
Colour	Black
Flammability rating	UL 94 V-2
Other properties	UV-resistant, heat stabilised, Halogen free, Silicone free



Product Ref.	Length L [mm]	Width W [mm]	Thickness [mm]	Bundle ø from ... to [mm]	Min. tensile strenght [N]	Quantity [pieces]	Tooling
TY23MX-A	92	2.3	0.9	4.8 - 22	80	1000	ERG50 ERG120*
TY24MX-A	140	3.6	1.1	5.2 - 35	133	1000	
TY25MX-A	186	4.8	1.2	6.2 - 48	220	1000	ERG120, L-500-EU
TY27MX-A	340	6.9	1.6	8 - 95	540	500	

* ERG120 can not be used with TY23MX-A and TY24MX-A

Description of product reference structure: see page 8
 Description of materials and properties: see pages 144 to 155
 For tooling specifications: see pages 130 to 143

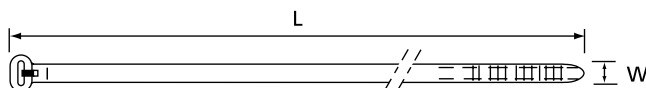

E49405

Ty-Rap® High Performance Cable Ties

Polyamide 4.6 cable ties – Extra high temperature

Characteristics

- Extreme continuous temperature rating: -40°C to +150°C (in air)
- For high temperature environments in industrial, OEM, MRO and commercial construction applications such as: metal processing, paper mills, lighting, automotive

Technical Information

Material - Moulding	Polyamide 4.6
Material - Locking barb	316 grade stainless steel
Temperature range	-40°C to +170°C
Min. Installation Temp.	-18°C
Colour	Light green
Flammability rating	UL 94 V-2
Other properties	Extra high temperature resistant, Halogen free, Silicon free



Product Ref.	Length L [mm]	Width W [mm]	Thickness [mm]	Bundle ø from ... to [mm]	Min. tensile strenght [N]	Quantity [pieces]	Tooling
TYHT23M	95	2.3	0.91	2 - 20	80	1000	
TYHT24M	143	3.6	1.07	2 - 29	178	1000	ERG120*
TYHT25M	192	4.8	1.22	5 - 45	220	1000	ERG50
TYHT28M	367	4.8	1.27	5 - 102	220	1000	WT199
TYHT27M	349	6.9	1.60	5 - 89	534	500	ERG120
TYHT277M	617	7.0	1.60	6 - 177	540	500	L-500-EU

* ERG120 can not be used with TYHT23M and TYHT24M

Description of product reference structure: see page 8
 Description of materials and properties: see pages 144 to 155
 For tooling specifications: see pages 130 to 143

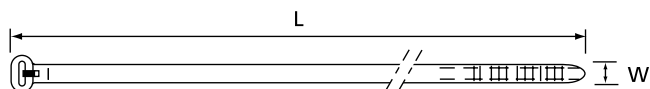

Ty-Rap® High Performance Cable Ties

Polyamide 12 cable ties – UV-resistant

Characteristics

- Polyamide 12 UV-resistant version, remains flexible in cold & dry environments.
- Ages better and has a better chemical resistance than Polyamide 6.6

Technical Information

Material - Moulding	Polyamide 12
Material - Locking barb	316 grade stainless steel
Temperature range	-40°C to +85°C
Colour	Black
Flammability rating	UL 94 V-2
Other properties	UV-resistant, Halogen free, Silicone free



Product Ref.	Length L [mm]	Width W [mm]	Thickness [mm]	Bundle ø from ... to [mm]	Min. tensile strenght [N]	Quantity [pieces]	Tooling
TYC25MX	186	4.70	1.17	3.5 - 45	155	1000	
TYC525MX	186	4.70	1.17	3.5 - 45	155	100	ERG50
TYC28MX	360	4.70	1.20	3.5 - 102	155	1000	ERG120
TYC272MX	222	7.60	1.60	6 - 51	380	500	
TYC27MX	343	7.62	1.50	6 - 89	380	500	
TYC527MX	343	7.62	1.50	6 - 89	380	50	ERG120
TYC29MX	771	7.60	1.60	6 - 229	380	500	L-500-EU

Description of product reference structure: see page 8

Description of materials and properties: see pages 144 to 155

For tooling specifications: see pages 130 to 143

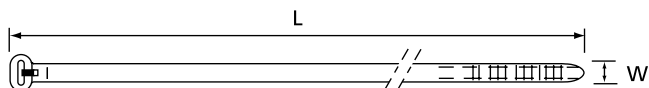

Ty-Rap® High Performance Cable Ties

Polypropylene cable ties – Weatherable

Characteristics

- Polypropylene weatherable version, for increased resistance to chemicals
- Resistant against inorganic acids, polyhydric alcohols, neutral and basic salts

Technical Information

Material - Moulding	Polypropylene
Material - Locking barb	316 grade stainless steel
Temperature range	-40°C to +85°C
Colour	Black
Flammability rating	UL 94 HB
Other properties	UV-resistant, Halogen free, Silicone free



Product Ref.	Length L [mm]	Width W [mm]	Thickness [mm]	Bundle ø from ... to [mm]	Min. tensile strenght [N]	Quantity [pieces]	Tooling
TYP23MX	92	2.4	1.0	2 - 16	50	1000	ERG50
TYP25MX	186	4.8	1.1	3.5 - 45	130	1000	
TYP28MX	360	4.8	1.1	3.5 - 102	130	1000	
TYP27MX	340	7.0	1.6	6 - 90	270	500	ERG120, L-500-EU

Description of product reference structure: see page 8
 Description of materials and properties: see pages 144 to 155
 For tooling specifications: see pages 130 to 143

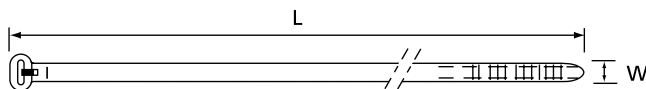

Ty-Rap® High Performance Cable Ties

Detectable cable ties

Characteristics

The Ty-Rap® Detectable Cable Ties from ABB incorporate a unique compound (patent pending) that can be detected by X-Ray equipment, metal detectors and visual inspection equipment.

Particularly recommended for applications in food, pharmaceutical and other contamination-sensitive industries using detection systems, where cable tie installation residuals (cut tails) are not allowed in the finished product.

- Detectable by metal detectors set at minimum 1.5 mm diameter ferrous sphere
- Detectable by X-Ray equipment
- Bright blue colour for an easy visual detection
- Help achieve the HACCP EU-Directive
- Available in standard Polyamide 6.6 or in Polypropylene version for liquid-processing applications
- Available in 5 different sizes in convenient small bags with Euroslot: 5 NDT, 4PDT

Technical Information

Material - Moulding	Polyamide 6.6 or Polypropylene
Material - Locking barb	316 grade stainless steel
Temperature range	-40°C to +85°C
Colour	Bright blue
Flammability rating	UL 94 V-2 (Polyamide 6.6) UL 94 HB (Polypropylene)
Other properties	Halogen free, silicone free



Product Ref.	Material	Length L [mm]	Width W [mm]	Bundle ø from ... to [mm]	Min. tensile strenght [N]	Quantity [pieces]	Tooling
DETECTABLE POLYAMIDE 6.6							
TY523M-NDT	Polyamide 6.6	92	2.4	2 - 16	80	100	ERG50
TY524M-NDT	Polyamide 6.6	140	3.6	2 - 29	134	100	
TY525M-NDT	Polyamide 6.6	186	4.8	3.5 - 45	180	100	ERG50
TY528M-NDT	Polyamide 6.6	360	4.8	3.5 - 102	220	100	ERG120
TY527M-NDT	Polyamide 6.6	340	7.0	6 - 90	540	50	ERG120, L-500-EU
DETECTABLE POLYPROPYLENE							
TY523M-PDT	Polypropylene	92	2.4	2 - 16	50	100	ERG50
TY525M-PDT	Polypropylene	186	4.8	3.5 - 45	130	100	ERG50
TY528M-PDT	Polypropylene	360	4.8	3.5 - 102	130	100	ERG120
TY527M-PDT	Polypropylene	340	7.0	6 - 90	270	50	ERG120, L-500-EU

Description of product reference structure: see page 8

Description of materials and properties: see pages 144 to 155

For tooling specifications: see pages 130 to 143

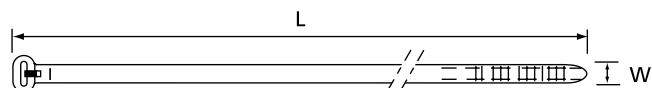

Ty-Rap® High Performance Cable Ties

Fluoropolymer cable ties – ECTFE

Characteristics

- Outstanding characteristic: lower smoke density when burnt
- Recommended for applications where smoke generation is a concern, such as plenum areas

Technical Information

Material - Moulding	Fluoropolymer ECTFE
Material - Locking barb	316 grade stainless steel
Temperature range	-60°C to +160°C
Min. Installation Temp.	-60°C
Colour	Maroon
Flammability rating	UL 94 V-0
Other properties	low smoke



Product Ref.	Length L [mm]	Width W [mm]	Thickness [mm]	Bundle ø from ... to [mm]	Min. tensile strenght [N]	Quantity [pieces]	Tooling
TW23M	92	2.3	1.15	1.5 - 22	80	1000	ERG50
TW523M	92	2.3	1.15	1.5 - 22	80	100	
TYV25M	186	4.7	1.30	3.0 - 48	220	1000	ERG50
TYV525M	186	4.7	1.30	3.0 - 48	220	100	ERG120

Description of product reference structure: see page 8

Description of materials and properties: see pages 144 to 155

For tooling specifications: see pages 130 to 143

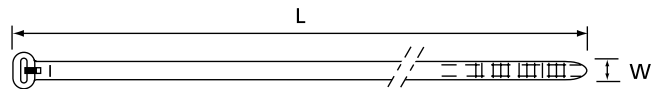

Ty-Rap® High Performance Cable Ties

Fluoropolymer cable ties – ETFE

Characteristics

- ETFE Fluoropolymer version, resistant to chemicals and to radiation
- Non-outgassing properties for zero gravity applications
- The best all around plastic material for cable ties
- Typical applications include: nuclear, power plants, space industry, etc.

Technical Information

Material - Moulding	Fluoropolymer ETFE
Material - Locking barb	316 grade stainless steel
Temperature range	-60°C to +170°C
Min. Installation Temp.	-60°C
Colour	Aquamarine
Flammability rating	UL 94 V-0
Other properties	Silicone free, inert to most solvents and chemicals, hydrolytically stable, radiation resistant. Non-outgassing properties for zero gravity applications.



Product Ref.	Length L [mm]	Width W [mm]	Thickness [mm]	Bundle ø from ... to [mm]	Min. tensile strenght [N]	Quantity [pieces]	Tooling
TYZ23M*	92	2.3	1.10	1.5 - 22	80	1000	ERG50 ERG120**
TYZ523M*	92	2.3	1.10	1.5 - 22	80	100	
TYZ25M	186	4.3	1.66	3 - 48	220	1000	
TYZ525M	186	4.3	1.66	3 - 48	220	100	
TYZ28M	360	4.4	1.66	3 - 102	220	500	
TYZ528M	360	4.3	1.66	3 - 102	220	100	
TYZ27M***	340	6.8	1.85	6 - 95	540	100	ERG120 L-500-EU
TYZ527M***	340	6.8	1.85	6 - 95	540	50	

* Product Ref. TYZ23M and TYZ523M are UL listed (E49405), all other items are UL recognized

** ERG120 not to be used on TYZ23M

*** Not on EC Declaration

Description of product reference structure: see page 8

Description of materials and properties: see pages 144 to 155

For tooling specifications: see pages 130 to 143

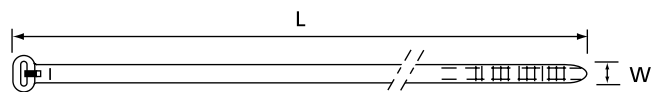

Special ties with steel locking barb

Integrated mounting hole cable ties

Characteristics

- Can be directly mounted onto a support with screws, bolts or rivets
- Mounting and bundling in one maintenance-friendly assembly.
- Typical application: cable harness manufacture and pre- and end- mounting of bundles and parts. Maintenance friendly mounting of cables, tubes and parts in all types and sizes of machines and installations - indoor and outdoor.

Technical Information

Material - Moulding	Polyamide 6.6
Material - Locking barb	316 grade stainless steel
Temperature range	-40°C to +85°C
Colour	Natural or UV-resistant black (see table)
Flammability rating	UL 94 V-2
Other properties	UV-resistant (black), Halogen free, Silicone free



Product Ref.	Colour	Diameter of mounting hole [mm]	Length L [mm]	Width W [mm]	Thick-ness [mm]	Bundle ø from ... to [mm]	Min. tensile strenght [N]	Quantity [pieces]	Tooling
TY33M	natural	3.0	102	2.3	0.9	2 - 16	80	1000	ERG50
TY533M	natural	3.0	102	2.3	0.9	2 - 16	80	100	
TY33MX	UV-resistant black	3.0	102	2.3	0.9	2 - 16	80	1000	
TY533MX	UV-resistant black	3.0	102	2.3	0.9	2 - 16	80	100	
TY34M	natural	4.4	151	3.5	1.0	2 - 29	180	1000	
TY534M	natural	4.4	151	3.5	1.0	2 - 29	180	100	
TY34MX	UV-resistant black	4.4	151	3.5	1.0	2 - 29	180	1000	
TY534MX	UV-resistant black	4.4	151	3.5	1.0	2 - 29	180	100	
TY635M	natural	4.0	198	4.7	1.1	3.5 - 45	220	1000	ERG50 ERG120
TY635MX	UV-resistant black	4.0	198	4.7	1.1	3.5 - 45	220	1000	
TY35M	natural	5.1	199	4.7	1.1	3.5 - 45	220	1000	
TY535M	natural	5.1	199	4.7	1.1	3.5 - 45	220	100	
TY35MX	UV-resistant black	5.1	199	4.7	1.1	3.5 - 45	220	1000	
TY535MX	UV-resistant black	5.1	199	4.7	1.1	3.5 - 45	220	100	
TY1435M	natural	6.7	198	4.7	1.1	3.5 - 45	220	1000	
TY37M	natural	6.7	356	7.7	2.0	6 - 90	540	500	
TY537M	natural	6.7	356	7.7	2.0	6 - 90	540	50	
TY37MX	UV-resistant black	6.7	356	7.7	2.0	6 - 90	540	500	
TY537MX	UV-resistant black	6.7	356	7.7	2.0	6 - 90	540	50	
TYF35M	natural	4.0	186	4.7	1.2	3.5 - 45	220	1000	ERG50 ERG120
TYF535M	natural	4.0	186	4.7	1.2	3.5 - 45	220	100	

Description of product reference structure: see page 8

Description of materials and properties: see pages 144 to 155

For tooling specifications: see pages 130 to 143

TY...M, TY...MX

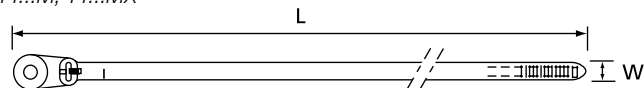

TYF35M, TYF535M

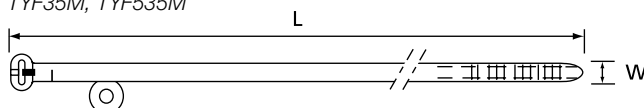

VG *
approved

VG95387
part 4, type B

* Some approvals may not be applicable to all the Product References.
Contact your Sales Office for approvals limitations

Special ties with steel locking barb

Panel mounting cable ties

Characteristics

- Fastening and clip-mounting in one
- Fast pre- or on-site-assembly for a range of panel thickness up to 4.0 mm
- Fast and secure clip-mounting

Technical Information

Material - Moulding	Polyamide 6.6
Material - Locking barb	316 grade stainless steel
Temperature range	-40°C to +85°C
Colour	Natural or UV-resistant black (see table)
Flammability rating	UL 94 V-2
Other properties	UV-resistant (black), Halogen free, Silicone free



Product Ref.	Colour	Diameter of mounting hole [mm]	Length L [mm]	Width W [mm]	Thickness [mm]	Bundle diameter from ... to [mm]	Minimum tensile strength [N]	Suitable for board/wall thickness from to [mm]	Quantity [pieces]	Tooling
ANCHOR TYPE										
TY54SM	natural	4.5 - 5.2	150	3.5	1.0	2 - 32	130	0.1 - 2.5	1000	
TY54SMX	UV-resistant black	4.5 - 5.2	150	3.5	1.0	2 - 32	130	0.1 - 2.5	1000	ERG50
TY38M	natural	6.4 - 6.7	200	4.7	1.3	3.5 - 44	220	1.0 - 4.0	1000	
TY38MX	UV-resistant black	6.4 - 6.7	200	4.7	1.3	3.5 - 44	220	1.0 - 4.0	1000	ERG50 ERG120
STANDARD TYPE										
696-41836	natural	5.8 - 7.5	197	4.8	1.1	3.5 - 45	220	2.2 - 3.7	1000	
696-41836X	UV-resistant black	5.8 - 7.5	197	4.8	1.1	3.5 - 45	220	2.2 - 3.7	1000	ERG50 ERG120

Description of product reference structure: see page 8
 Description of materials and properties: see pages 144 to 155
 For tooling specifications: see pages 130 to 143

TY...

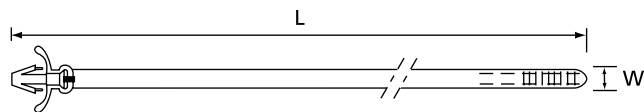

696-...

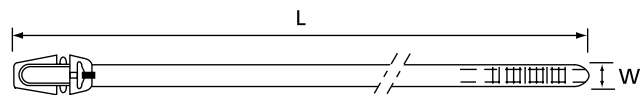

Special ties with steel locking barb

Blind mounting cable ties

Characteristics

- Suitable for hard-to-reach areas
- Fast hidden mounting on walls and vehicle chassis
- Twist off the locking head
- Pull the tie end through the fastening hole
- Place locking head on tie end
- Pull tight and cut off excess
- In the locked state, the locking head neatly covers the mounting hole

Technical Information

Material - Moulding	Polyamide 6.6
Material - Locking barb	316 grade stainless steel
Temperature range	-40°C to +85°C
Colour	Natural or UV-resistant black (see table)
Flammability rating	UL 94 V-2
Other properties	UV-resistant (black), Halogen free, Silicone free

Product Ref.	Colour	Diameter of mounting hole [mm]	Length L [mm]	Width W [mm]	Thick-ness [mm]	Bundle ø from ... to [mm]	Min. tensile strenght [N]	Quantity [pieces]	Tooling
TYG34M	natural	6.4 - 7.0	160	3.6	1.1	2 - 32	180	1000	ERG50
TYG534M	natural	6.4 - 7.0	160	3.6	1.1	2 - 32	180	100	
TYG34MX	UV-resistant black	6.4 - 7.0	160	3.6	1.1	2 - 32	180	1000	
TYG534MX	UV-resistant black	6.4 - 7.0	160	3.6	1.1	2 - 32	180	100	

Description of product reference structure: see page 8

Description of materials and properties: see pages 144 to 155

For tooling specifications: see pages 130 to 143

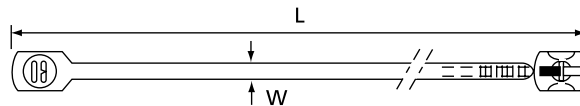
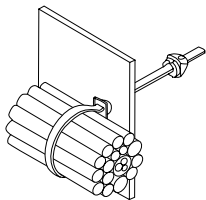

Special ties

Blind mounting cable ties

Characteristics

- Suitable for hard-to-reach areas
- Fast hidden mounting on walls and vehicle chassis
- Ideal for mounting on vehicle chassis. Can still be released before final tensioning
- In the locked state, the locking head neatly covers the mounting hole

Technical Information

Material	Polyamide 6.6
Temperature range	-40°C to +85°C
Colour	UV-resistant black
Flammability rating	UL 94 V-2
Other properties	UV-resistant, Halogen free, Silicone free



Product Ref.	Diameter of mounting hole [mm]	Length L [mm]	Width W [mm]	Thick-ness [mm]	Bundle σ from ... to [mm]	Min. tensile strenght [N]	Quantity [pieces]	Tooling
TY41M	8.1 - 17.3	244	5.7	1.7	5 - 60	300	500	ERG120
TY541M	8.1 - 17.3	244	5.7	1.7	5 - 60	300	50	

Description of product reference structure: see page 8

Description of materials and properties: see pages 144 to 155

For tooling specifications: see pages 130 to 143

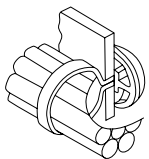
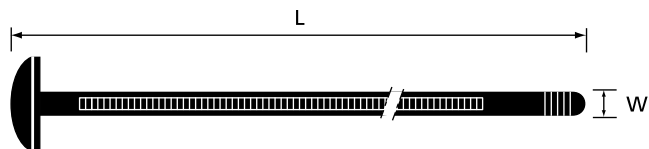
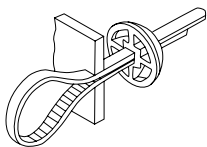

Special ties with steel locking barb

Integrated peg / nail cable ties

Characteristics

- TY545MX, with integrated nail for mounting onto wood or similar materials
- TY544MX, with integrated peg for mounting onto porous concrete or similar materials (masonry)
- Very simple application

Technical Information

Material - Moulding	Polyamide 6.6
Material - Locking barb	316 grade stainless steel
Temperature range	-40°C to +85°C
Colour	UV-resistant black
Flammability rating	UL 94 V-2
Other properties	UV-resistant, Halogen free, Silicone free



Product Ref.	Diameter of mounting hole [mm]	Length L [mm]	Width W [mm]	Thick-ness [mm]	Bundle ø from ... to [mm]	Min. tensile strenght [N]	Mounting hole depth [mm]	Quantity [pieces]	Tooling
TY544MX	6.4	200	4.6	1.0	3.5 - 45	220	25 min.	50	ERG50
TY545MX	-	200	4.7	1.0	4.7 - 38.1	220	-	50	ERG120

Description of product reference structure: see page 8

Description of materials and properties: see pages 144 to 155

For tooling specifications: see pages 130 to 143

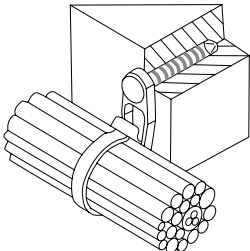

TY544MX

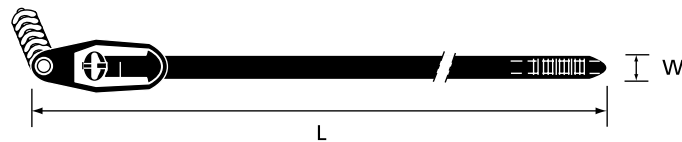

TY545MX

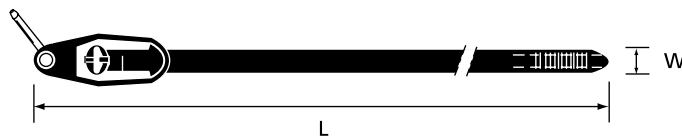

Special ties

Releasable cable ties

Characteristics

- For temporary but strong bundling, especially during control box wiring
- Very simple application
- Available in 2 lengths for different applications
- May be re-used many times
- No tooling necessary

Technical Information

Material	Polyamide 6.6
Temperature range	-40°C to +85°C
Colour	Natural
Flammability rating	UL 94 V-2
Other properties	Halogen free, Silicone free



Product Ref.	Length L [mm]	Width W [mm]	Thickness [mm]	Bundle ø from ... to [mm]	Min. tensile strenght [N]	Quantity [pieces]
TYR505	190	4.7	1.19	10 - 44	220	100
TYR508	364	4.7	1.19	10 - 102	220	100

Description of product reference structure: see page 8

Description of materials and properties: see pages 144 to 155

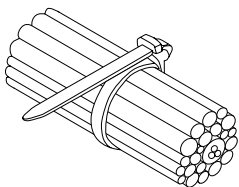
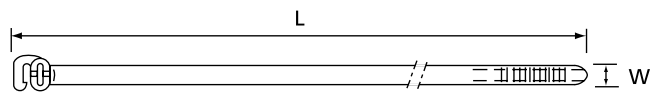

Pull end of tie through head. Turn tie end back on itself and insert into side of clip. To open, release tie end from clip and open tie.

Special ties

Releasable lashing ties with incorporated fastener

Characteristics

- For temporary but strong bundling, especially during control box wiring
- Very simple application
- Available in 2 lengths for different applications
- May be re-used many times
- No tooling necessary

Technical Information

Material	Polyamide 6.6
Temperature range	-40°C to +85°C
Colour	UV-resistant black
Flammability rating	UL 94 V-2
Other properties	Halogen free, Silicone free



Product Ref.	Length L [mm]	Width W [mm]	Thickness [mm]	Bundle ø from ... to [mm]	Min. tensile strenght [N]	Quantity [pieces]
TY409	483	12.7	2.0	45 - 121	890	100
TY5409	483	12.7	2.0	45 - 121	890	25

Description of product reference structure: see page 8

Description of materials and properties: see pages 144 to 155

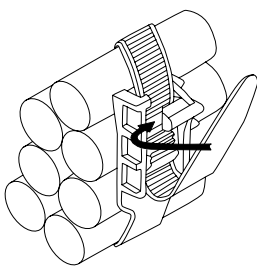
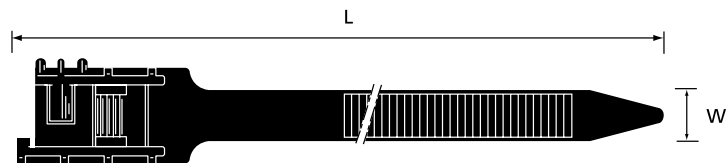

Introduce the cable tie tail into the lower slot in the head. Tighten the tie and pull it back. Slide in the tie under the catch from the side until it snaps into position.

Special ties

Releasable 2-piece lashing ties, pre-assembled version

Characteristics

- Heavy-duty lashing ties, in cut lengths with pre-assembled heads
- Also available on reel with separate heads (see page 34)
- UV-resistant Polypropylene, ideal for applications where chemical resistance is important (heads in weatherable rigid Polyamide 6.6)
- Extremely robust (670N)
- Easily releasable & reusable
- 2 types of head: type A: no mounting hole
type B: with mounting hole
- Typical applications: Indoor and outdoor fastening of cables, pipes and other parts in industry, shipbuilding, chemical industry etc

Technical Information

Material - Tie	Weatherable Polypropylene
Material - Head	Polyamide 6.6
Temperature range	Head: -40°C to +85°C Tie: -55°C to +110°C
Colour	UV-resistant black
Flammability rating	UL 94 V-2
Other properties	UV-resistant, Halogen free



Product Ref.	Diameter of mounting hole [mm]	Length L [mm]	Width W [mm]	Thickness [mm]	Bundle ø from ... to [mm]	Min. tensile strenght [N]	Quantity [pieces]
TY53418PX	6.9	457	13.2	1.9	45 - 127	670	25
TY5418PX	-	457	13.2	1.8	45 - 127	670	25
TY5424PX	-	610	13.2	1.8	10 - 178	670	25
TY5442PX	-	1067	13.2	1.8	10 - 305	670	10
TY5460PX	-	1524	13.2	1.8	10 - 457	670	10

Description of product reference structure: see page 8

Description of materials and properties: see pages 144 to 155

TY54XXPX

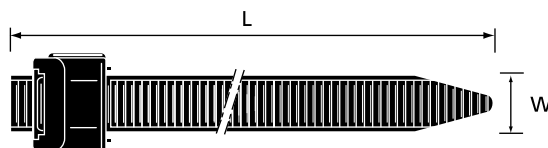
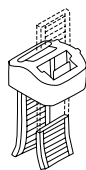

TY53418PX

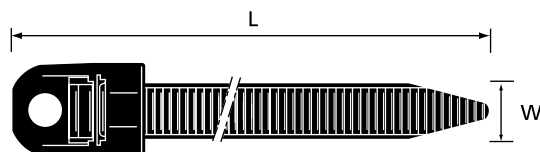
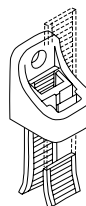

Special ties

Releasable 2-piece lashing ties on reel with separate heads

Characteristics

- Heavy-duty lashing ties on reel with separate heads
- Also available in cut lengths with pre-assembled heads (see page 33)
- UV-resistant Polypropylene, ideal for applications where chemical resistance is important (heads in weatherable rigid Polyamide 6.6)
- Extremely robust (670N)
- Easily releasable and reusable
- 2 types of head: type A: no mounting hole
type B: with mounting hole
- Typical applications: Indoor and outdoor fastening of cables, pipes and other parts in industry, shipbuilding, chemical industry etc.
- Product Ref. 696-41563: lashing tie on reel (300 m), in weatherable Polypropylene
- Product Ref. 696-41562: separate head, type A (no mounting hole), weatherable Polyamide 6.6 (200 pieces)
- Product Ref. 696-41614: separate head, type B (with mounting hole), weatherable Polyamide 6.6 (200 pieces) Mounting hole: Ø 6.9 mm
- Product Ref. TY4100PX: kit containing 30 m of lashing tie on reel + 50 separate heads, type A

Technical Information

Material - Tie	Weatherable Polypropylene
Material - Head	Polyamide 6.6
Temperature range	Head: -40°C to +85°C Tie: -55°C to +110°C
Colour	UV-resistant black
Flammability rating	UL 94 V-2
Other properties	UV-resistant, Halogen free



Product Ref.	Lashing tie, dimensions			Separate locking heads		Min. tensile strength of assembly [N]
	Length [mm]	Width [mm]	Thickness [mm]	Quantity [pieces]	Type	
696-41563	300	13.2	1.8	-	-	670
696-41562	-	-	-	200	Type A, no mounting hole	670
696-41614	-	-	-	200	Type B, with mounting hole	670
TY4100PX	30	13.2	1.8	50	Type A, no mounting hole	670

Description of product reference structure: see page 8

Description of materials and properties: see pages 144 to 155

696-41563

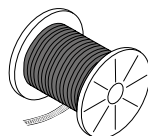

696-41562



696-41614



TY4100PX

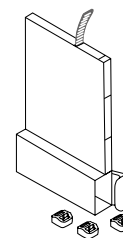

696-41563



Special ties with steel locking barb

Cable ties with identification tag

Characteristics

- Identification ties with incorporated label for durable marking and tying
- Label forms onto the bundle for types TY512M, TY51M and protrudes for ties TY532M and TY53M
- Series 51M is MIL (MS-3368-5) approved
- Trouble-free installation
- All edges are rounded to make installation easier
- Available in bulk packaging (500/1000 pieces) or in small packaging (100 pieces)

Technical Information

Material - Moulding	Polyamide 6.6
Material - Locking barb	316 grade stainless steel
Temperature range	-40°C to +85°C
Colour	Natural
Flammability rating	UL 94 V-2
Other properties	Halogen free, Silicone free



Product Ref.	MIL Spec.	Length L [mm]	Width W [mm]	Thickness [mm]	Bundle ϕ from ... to [mm]	Min. tensile strenght [N]	Label dimensions [mm]	Quantity [pieces]	Tooling
TY51M	MS-3368-5	92	2.4	1.0	10 - 16	80	25.4 x 7.9	500	ERG50
TY551M	MS-3368-5	92	2.4	1.0	10 - 16	80	25.4 x 7.9	100	
TY512M	-	210	2.4	1.0	10 - 51	80	25.4 x 7.9	1000	
TY5512M	-	210	2.4	1.0	10 - 51	80	25.4 x 7.9	100	
TY53M	-	102	2.4	1.0	2 - 16	80	20.6 x 9.3	500	
TY553M	-	102	2.4	1.0	2 - 16	80	20.6 x 9.3	100	
TY532M	-	212	2.4	1.0	2 - 51	80	20.6 x 9.3	1000	
TY5532M	-	212	2.4	1.0	2 - 51	80	20.6 x 9.3	100	

For other materials and colours contact your Sales Office

Description of product reference structure: see page 8
 Description of materials and properties: see pages 144 to 155
 For tooling specifications: see pages 130 to 143

TY53M, TY553M, TY532M, TY5532M

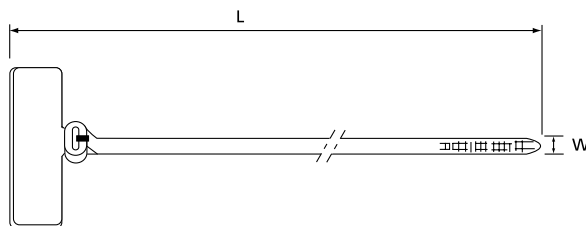

TY51M, TY551M, TY512M, TY5512M

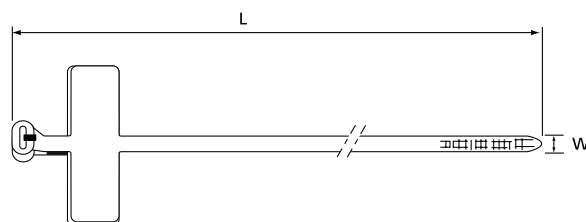

Special ties with steel locking barb

Cable ties with identification tag

Characteristics

- Identification ties with incorporated label for durable marking and tying
- Label forms onto the bundle
- 5 different versions, up to 4 straps, in bulk and small packaging
- 4 versions (up to 3 straps) are Mil-specified
- Trouble free installation
- Labelling of bundles up to 102 mm diameter
- All edges are rounded and surfaces smoothed to make installation easier

Technical Information

Material - Moulding	Polyamide 6.6
Material - Locking barb	316 grade stainless steel
Temperature range	-40°C to +85°C
Colour	Natural
Approvals	MIL: MS-3368 -1, -2, -3, -4
Flammability rating	UL 94 V-2
Other properties	Halogen free, Silicone free



Product Ref.	MIL Spec.	Length L [mm]	Width W [mm]	Thick-ness [mm]	Bundle ø from ... to [mm]	Min. tensile strenght [N]	Label dimensions [mm]	Quantity [pieces]	Tooling
TY48M	MS-3368-2	360	4.8	1.1	19 - 102	220	13.1 x 57.2	1000	ERG50 ERG120
TY548M	MS-3368-2	360	4.8	1.1	19 - 102	220	13.1 x 57.2	100	
TY46M	MS-3368-1	184	4.8	1.1	9.5 - 45	220	13.1 x 27.0	1000	
TY546M	MS-3368-1	184	4.8	1.1	9.5 - 45	220	13.1 x 27.0	100	
TY46MD	MS-3368-3	184	4.8	1.1	9.5 - 45	220 x 2	29.7 x 27.0	500	
TY546MD	MS-3368-3	184	4.8	1.1	9.5 - 45	220 x 2	29.7 x 27.0	50	
TY46MT	MS-3368-4	184	4.8	1.1	9.5 - 45	220 x 3	46.0 x 27.0	500	
TY546MT	MS-3368-4	184	4.8	1.1	9.5 - 45	220 x 3	46.0 x 27.0	100	
TY46MF	-	184	4.8	1.1	9.5 - 45	220 x 4	63.1 x 27.0	250	
TY546MF	-	184	4.8	1.1	9.5 - 45	220 x 4	63.1 x 27.0	50	

For other materials and colours contact your Sales Office

Description of product reference structure: see page 8

Description of materials and properties: see pages 144 to 155

For tooling specifications: see pages 130 to 143

TY48M

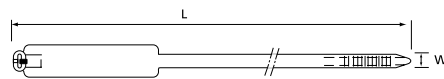

TY46M

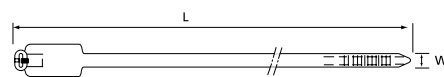

TY46MD

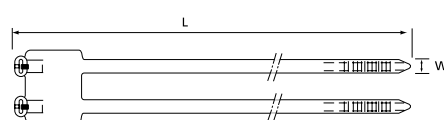

TY46MT

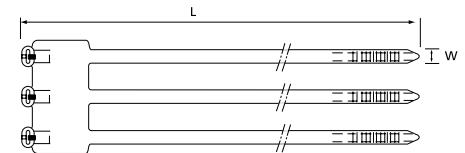

TY46MF

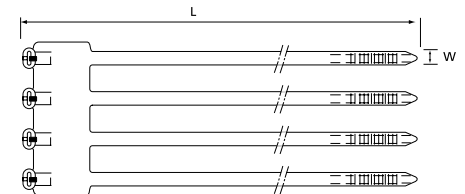

Cable support system with metallic locking barb

Pre-assembled Deltec® cable ties

Characteristics

- Provides a strong, long-life and cost saving method of securing communication and overhead cables
- Double locking head with corrosion resistant locking barbs in copper alloy
- Proven years of service: designed to last a minimum of 20 years outdoor
- No sharp edges: operator friendly, cable friendly!
- Easy to install, low installation costs
- Extremely robust ties, with high tensile strength (1110N) after fastening
- Available either in pre-cut and pre-assembled lengths, or on reels with separate heads for total flexibility
- Choice of specific spacers and accessories
- Month and year of manufacture stamped into strap material

Technical Information

Material - Strap & head	Toughened weatherable acetal
Material - Locking barb	Marine grade, corrosion-resistant copper alloy
Temperature range	-40°C to +85°C
Flammability rating	UL 94 HB
Colour	Black
Other properties	UV-resistant, Halogen free, superior resistance to moisture and salt environments



Product Ref.	Length L [mm]	Width W [mm]	Bundle ø from ... to [mm]	Min. tensile strenght [N]	Quantity [pieces]	Tooling
CSS-100	254.0	12.7	60	1110	50	WT3D L-500-EU
TYD5135M	342.9	12.7	90	1110	25	
CSS-160	406.4	12.7	110	1110	50	
TYD5270M	685.8	12.7	200	1110	10	

For tooling specifications: see pages 130 to 143

Note: the recommended maximum continuous static loading for the Deltec® straps is 90 N per strap. For best results suggested spacing is 35 to 40 cm. It is the responsibility of the user to determine whether or not their application meets our recommendation.

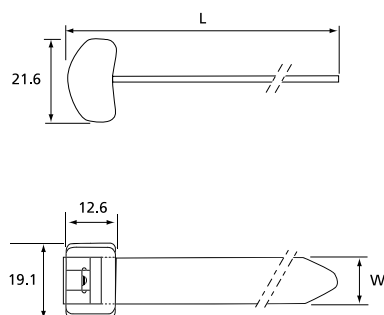

Cable support system with metallic locking barb

Strap on reel

Characteristics

- Strap on reel, with separate head
- Total flexibility & no waste: cut at the desired length
- Easy to store: reduced inventory
- User friendly

Technical Information

Material	Toughened weatherable acetal
Temperature range	-40°C to +85°C
Flammability rating	UL 94 HB
Colour	Black
Other properties	UV-resistant, Halogen free, superior resistance to moisture and salt environments



Product Ref.	Length per reel L [m]	Width W [mm]	Min. tensile strength [N]	Quantity [reels]	Tooling
TYD-50R	15.2	12.7	1110	1	WT3D
696-41794	304.8	12.7	1110	1	L-500-EU

For tooling specifications: see pages 130 to 143

Note: the recommended maximum continuous static loading for the Deltec® straps is 90 N per strap. For best results suggested spacing is 35 to 40 cm.

It is the responsibility of the user to determine whether or not their application meets our recommendation.

Cable support system with metallic locking barb

Double locking heads

Technical Information

Material - moulding	Toughened weatherable acetal
Material - locking barb	Marine grade, corrosion-resistant copper alloy
Temperature range	-40°C to +85°C
Flammability rating	UL 94 HB
Colour	Black
Other properties	UV-resistant, Halogen free, superior resistance to moisture and salt environments



Product Ref.	Length L [mm]	Width W [mm]	Height H [mm]	Quantity [pieces]
TYD-LH	21.6	19.1	12.6	25
696-41795	21.6	19.1	12.6	1000

To be assembled with Deltec® strap on reel

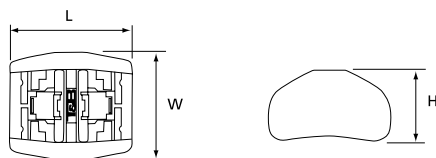

Cable support system with metallic locking barb

Deltec® Kits

Characteristics

- Convenient kits containing several reels of strap and separate locking heads, to provide all you need to be efficient on the field
- 2 configurations to match your need



Product Ref.	Length per reel [mm]	Reels Quantity [reels]	Locking heads Quantity [pieces]
CSS-5K	15.2	5	150
CSS-10K	15.2	10	300

Ty-Rap® High Performance Cable Ties

Cable spacers

Characteristics

- Stackable height in 12.7 mm increments, for any desired spacing and all cable sizes - no need to stock multiple sizes of individual height spacers
- Designed to retain strap on each side and cradle the cable, providing restricted movement of spacer and preventing damage to cable
- Suitable for coaxial cables
- Can be used for parallel routing or for perpendicular cables

Technical Information

Material	Weather-resistant polypropylene
Temperature range	-40°C to +85°C
Flammability rating	UL 94 HB
Colour	Black
Other properties	UV-resistant, Halogen free



Product Ref.	Length L [mm]	Width W [mm]	Height H [mm]	Quantity [pieces]
TCP5255	53.3	30.5	12.7	25
TCP360	53.3	30.5	12.7	100

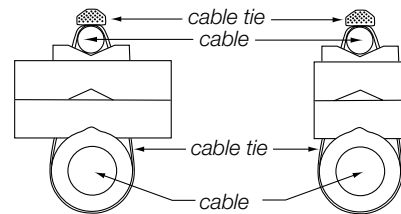
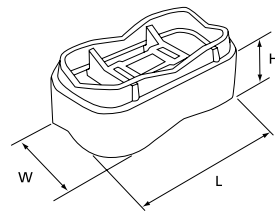

Cable support system with metallic locking barb

Base and hanger

Characteristics

- To secure the cables to all types of surfaces

Technical Information

Material Zinc plated steel
 Colour Metallic



Product Ref.	Dimensions					Mounting hole diameter [mm]	Quantity [pieces]
	A [mm]	B [mm]	C [mm]	D [mm]	E [mm]		
CSS-B	48.4	14.3	7.1	15.1	5.6	6.7 (2x)	50
CSS-H	22.5	22.2	29.8	13.6	8.3	6.9	50

CSS-H

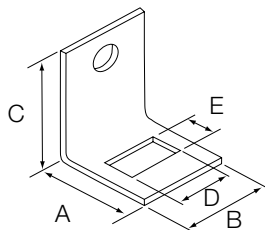

CSS-B

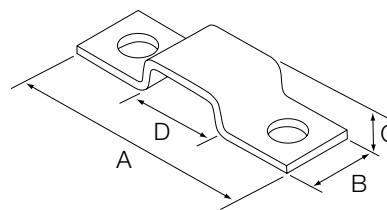



Table of Content

Ty-Fast® All plastic cable ties

Ty-Rap® High Performance Cable Ties	2
Ty-Fast® All-plastic cable ties	42
Product reference structure	46
Standard cable ties - Small quantity bags	47
Standard cable ties - Jar	48
Extra-long cable ties	49
Heavy-duty cable ties	50
UL 94 V-0 flame retardant cable ties	51
Special all-plastic cable ties	52
Integrated mounting hole cable ties	52
Releasable panel mounting cable ties	53
Releasable cable ties	54
Cable ties with identification tag	55
Special double-headed ties	56
Low profile in-line fasteners	57
Hook & Loop fasteners	58
Polyamide 6.6 Twist Tail® cable tie	60
Heavy-duty installation ties	61
Heavy-duty double headed installation ties	61
Accessories	63
Spec-Kon® cable ties	64
Ty-Met™ Stainless steel cable ties	66
Mounting bases and accessories	84
Cable protection systems	120
Cable tie tooling	130
Material specifications	144

All plastic cable ties Introduction



All plastic cable ties

Ty-Fast[®], Col-Ty[™], Safe-Ty[™] and Ty-Grip[™]

ABB offers a complete range of all plastic cable ties to cover the most demanding applications.

Ty-Fast[®] All plastic ties

The all-plastic cable ties are available in lengths from 112 mm to 1214 mm and widths from 2.4 mm to 13.2 mm, offering a loop tensile strength up to 1120 N. Those cable ties will satisfy bundling requirements up to 381 mm. Those cable ties are halogen and silicone free Polyamide 6.6 and are available in 12 different colours.

Ty-Fast[®] cable ties meet shipbuilding classification such as Germanischer Lloyd/DNV-GL, Lloyd's Register of Shipping, Bureau Veritas but also Mil Specification and QPL. Ty-Fast[®] cable ties have a CE declaration, supported by compliance to the low voltage directive and EN/IEC 62275 and UL 62275.

State-of-the-art robotic and raw material handling equipment assures product and material integrity throughout the manufacturing process. The integrally formed Polyamide pawl combines low insertion and high locking strength.

A rounded, low-profile head makes for less snags, tails have improved two-sided finger grip design that helps the operator grasp and pull ties snug. The Sure Grip tab keeps the tail from popping out while being threaded, then holds it securely for final tightening by hand or tool.

Heavy duty installation ties

Col-Ty[™] -the heavy installation tie - is mainly used for securing and bundling of cables in the utility and construction industries.

Col-Ty[™] is ideal for hazardous environments, low temperatures and humidity. Col-Ty[™] has a low profile double locking head with serration on the outer side of the tie, which eliminates the risk of damage to the cable.

Low-profile inline fasteners

The Safe-Ty[™] design from ABB is ideal for use where precision bundling is required and clearance is a necessity. A unique saddle back design curves to form a snug fit around the bundle, and allows for easy pull-through in bulkheads and any other tight spaces.

Hook & loop fasteners

Ty-Grip[™] cable ties are very easy to release and re-use, making them ideal for applications where changes are anticipated or continuous access is required. There is no risk of over-tightening the cables, which makes the Ty-Grip[™] hook & loop fasteners ideal for specific applications in fiber optics, computer network wiring, telecom cables, etc.

All plastic cable ties

Product reference structure

Ty-Fast® code

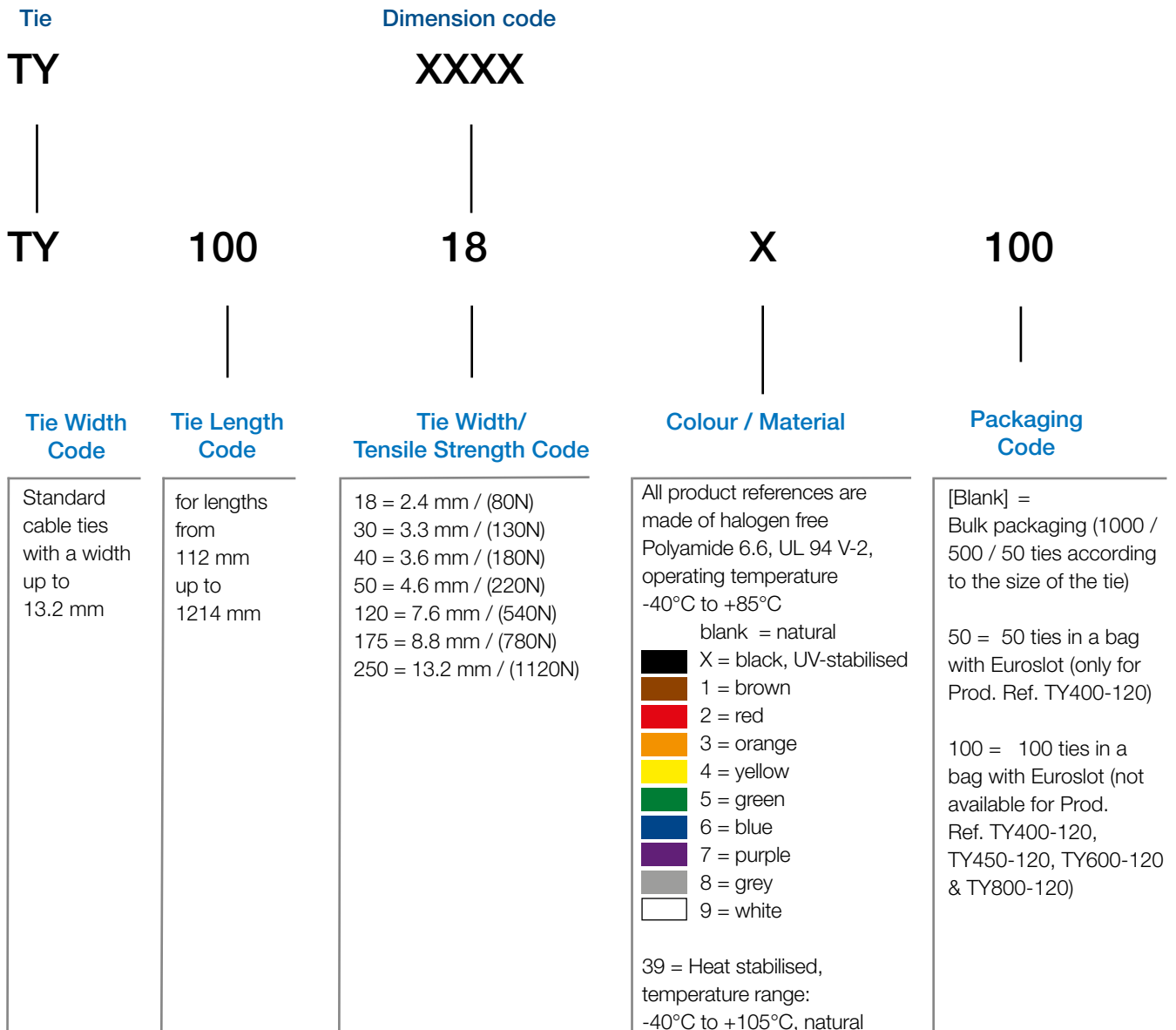

Note: Nylon (Polyamide) is inherently susceptible to environmental conditions. Ty-Fast® cable ties are moisturised to optimum performance levels at machine-side and should be stored in cool dry areas out of direct sunlight. Cable ties are packaged in plastic bags to contain moisture and should remain sealed until ready for use

All plastic cable ties

Standard cable ties

Characteristics

State-of-the-art robotic and raw material handling equipment assures product and material integrity throughout the manufacturing process.

- The integrally formed Polyamide pawl combines low insertion and high locking strength
- A rounded, low-profile head makes for less snags
- Tails have improved two-sided finger grip design that helps the operator grasp and pull ties snug
- Sure Grip tab keeps the tail from popping out while being threaded, then holds it securely for final tightening by hand or tool
- Quick and easy pull through increases productivity, reduces operator fatigue

Technical Information

Material	Polyamide 6.6 (*)
Temperature range	-40°C to +85°C (natural and colours, excl. UV-resistant black) -40°C to +105°C (black)
Min. Installation Temp.	-20°C
Colour	Natural as standard colour (*)
Approvals	MIL: MS 3367-x (see table)
Flammability rating	UL 94 V-2
Other properties	Halogen free, Silicone free

(*) For other materials and colours see the product reference structure page 46



Product Ref.	MIL Spec.	Length	Width	Bundle ø	Min. tensile strength	Quantity	Tooling	
		L [mm]	W [mm]	from ... to [mm]	[N]	[pieces]		
TY100-18	MS-3367-4	112	2.4	1.5 - 25	80	1000	ERG50	
TY125-18	-	136	2.4	1.5 - 32	80	1000		
TY150-18	-	163	2.4	1.5 - 38	80	1000		
TY125-30	-	143	3.3	1.5 - 32	130	1000		
TY125-40*	MS-3367-5	141	3.6	1.5 - 32	180	1000		
TY200-40	-	205	3.6	1.5 - 50	180	1000		
TY300-40	-	290	3.6	1.5 - 76	180	1000		
TY400-40	-	368	3.6	6.35 - 102	180	1000		
TY125-50	-	140	4.6	1.5 - 32	220	1000		ERG50 ERG120
TY175-50	MS-3367-1	186	4.6	3.17 - 44	220	1000		
TY225-50	-	226	4.6	3.17 - 57	220	1000		
TY300-50	MS-3367-7	291	4.6	3.17 - 76	220	1000		
TY400-50	MS-3367-2	366	4.6	3.17 - 102	220	1000	ERG120 L-500-EU WT3D	
TY200-120	-	219	7.6	15 - 50	540	500		
TY300-120	-	289	7.6	15 - 76	540	100		
TY400-120	MS-3367-3	375	7.6	15 - 102	540	50 / 100		
TY450-120	-	457	7.6	15 - 124	540	50		
TY600-120	-	610	7.6	15 - 184	540	50		
TY800-120	MS-3367-6	706	7.6	6.35 - 204	540	50		

* Operation temperature: -30°C to +85°C

Description of Product Reference structure: see page 46

Description of materials and properties: see pages 144 to 155

For tooling specifications: see pages 130 to 143



** Some approvals may not be applicable to all the Product References. Contact your Sales Office for approvals limitations

All plastic cable ties

Standard cable ties – Jar

Characteristics

- Ty-Fast® cable ties packed in an attractive plastic jar
- Ideal product for the distribution market
- Different dimensions in the same packaging: 112 mm x 2.4 mm, 141 mm x 3.6 mm and 186 mm x 4.7 mm
- Tensile strength from 80N to 220N
- Available in 3 different packaging configurations: 1 in natural cable ties and 2 in black cable ties
- Ideal product when small volumes are needed for various applications

Technical Information

Material	Polyamide 6.6
Temperature range	-40°C to +85°C (natural) -40°C to +105°C (black)
Min. Installation Temp.	-20°C
Colour	Natural or UV-resistant black (see table)
Flammability rating	UL 94 V-2
Other properties	UV-resistant (black) Halogen free, Silicone free



Product Ref.	Quantity	Colour	Mil Spec	Length	Width	Bundle diameter from ... to	Minimum tensile strength	Tooling
				L	W			
	[pieces]			[mm]	[N]	[mm]	[N]	
JTN-500	2 x 100	natural	-	112	2.4	1.6 - 25	80	ERG50
	1 x 100	natural	MS-3367-5	141	3.6	1.6 - 32	180	
	2 x 100	natural	MS-3367-1	186	4.6	1.6 - 44	220	
JTB-500	2 x 100	UV-resistant black	-	112	2.4	1.6 - 25	80	ERG50
	1 x 100	UV-resistant black	MS-3367-5	141	3.6	1.6 - 32	180	
	2 x 100	UV-resistant black	MS-3367-1	186	4.6	1.6 - 44	220	
JTB1-500	2 x 100	UV-resistant black	-	112	2.4	1.6 - 25	80	ERG50
	2 x 100	UV-resistant black	MS-3367-5	141	3.6	1.6 - 32	180	
	1 x 100	UV-resistant black	MS-3367-1	186	4.6	1.6 - 44	220	

Description of Product Reference structure: see page 46

Description of materials and properties: see pages 144 to 155

For tooling specifications: see pages 130 to 143

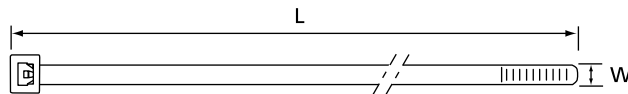

All plastic cable ties

Extra-long cable ties

Characteristics

- Extremely long ties (up to 1214 mm)
- Robust construction (778N), for demanding applications where superior tensile strength is required
- The extra long Ty-Fast® ties are available in natural colour for indoor applications and in UV-resistant black for outdoor applications

Technical Information

Material	Polyamide 6.6
Temperature range	-40°C to +85°C
Colour	Natural or UV-resistant black (see table)
Flammability rating	UL 94 V-2
Other properties	UV-resistant (black), Halogen free, Silicone free



Product Ref.	Colour	Length L [mm]	Width W [mm]	Bundle ø from ... to [mm]	Min. tensile strenght [N]	Quantity [pieces]	Tooling
TY600-175X	UV-resistant black	631	9.0	7 - 187	778	50	WT3D L300FR L-500-EU
TY600-175	Natural	631	9.0	7 - 187	778	50	
TY900-175X	UV-resistant black	916	8.8	7 - 263	778	50	
TY900-175	Natural	916	8.8	7 - 263	778	50	
TY1000-175X	UV-resistant black	1041	8.8	7 - 305	778	50	
TY1000-175	Natural	1041	8.8	7 - 305	778	50	
TY1200-175	UV-resistant black	1233	8.6	38 - 368	778	50	
TY1200-175	Natural	1233	8.6	38 - 368	778	50	

Description of Product Reference structure: see page 46

Description of materials and properties: see pages 144 to 155

For tooling specifications: see pages 130 to 143

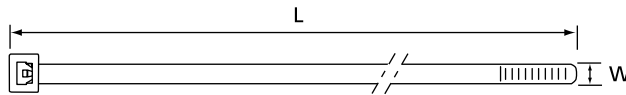

All plastic cable ties

Heavy-duty cable ties

Characteristics

- Extremely robust ties (1120N), for demanding applications where extreme tensile strength is required
- Available in natural colour for indoor applications and in UV-resistant black for outdoor applications

Technical Information

Material	Polyamide 6.6
Temperature range	-40°C to +85°C
Colour	Natural or UV-resistant black (see table)
Flammability rating	UL 94 V-2
Other properties	UV-resistant (black), Halogen free, Silicone free



Product Ref.	Colour	Length	Width	Bundle ϕ from ... to [mm]	Min. tensile strength [N]	Quantity [pieces]	Tooling
		L [mm]	W [mm]				
TYL300M	natural	300	13.2	75	1120	50	L-500-EU
TYL300MX	UV-resistant black	300	13.2	75	1120	50	
TYL546M	natural	546	13.2	140	1120	50	
TYL546MX	UV-resistant black	546	13.2	140	1120	50	

Description of Product Reference structure: see page 46

Description of materials and properties: see pages 144 to 155

For tooling specifications: see pages 130 to 143

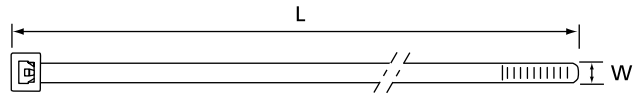

All plastic cable ties

UL 94 V-0 flame retardant cable ties

Characteristics

- Similar to our Ty-Rap® range of flame retardant ties, these all-plastic ties are made from low smoke flame retardant Polyamide 6.6 and meet the requirements of UL 94 V-0.
- Ideal for use where low flammability and low smoke are necessary such as public transport / buildings, tunnels etc.

Technical Information

Material	Polyamide 6.6
Temperature range	-40°C to +85°C
Colour	Milky white
Flammability rating	UL 94 V-0
Other properties	Limited fire hazard (low smoke), Halogen free, Silicone free



Product Ref.	Length L [mm]	Width W [mm]	Bundle ø from ... to [mm]	Min. tensile strenght [N]	Quantity [pieces]	Tooling
TS1025HF	100	2.5	2 - 22	80	100	ERG50
TS1435HF	140	3.6	2.5 - 33	180	100	
TS2045HF	200	4.8	3 - 50	220	100	
TS2845HF	280	4.8	5 - 70	220	100	
TS3645HF	370	4.8	5 - 102	220	100	
TS3675HF	370	7.6	5 - 102	540	100	ERG120, L-500-EU, WT3D

Description of materials and properties: see pages 144 to 155

For tooling specifications: see pages 130 to 143

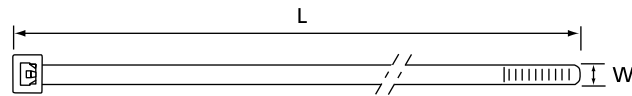

Special all-plastic cable ties

Integrated mounting hole cable ties

Characteristics

- Cable tie can be directly mounted onto a support with screws, bolts or rivets.
- Mounting and bundling in one maintenance-friendly assembly.
- Cable harness manufacture and pre- and end- mounting of bundles and parts.
- UV-resistant version, especially recommended for outdoor applications

Technical Information

Material	Polyamide 6.6
Temperature range	-40°C to +85°C
Colour	Natural or UV-resistant black (see table)
Flammability rating	UL 94 V-2
Other properties	UV-resistant (black), Halogen free, Silicone free



Product Ref.	Colour	Length L [mm]	Width W [mm]	Fixing scrw size	Bundle ø from ... to [mm]	Min. tensile strenght [N]	Quantity [pieces]	Tooling
L-5-30MH-0-C*	UV-resistant black	152	3.3	M4	2 - 32	130	100	ERG50
L-5-30MH-9-C*	natural	152	3.3	M4	2 - 32	130	100	
L-7-50MH-0-C	UV-resistant black	208	4.7	M5	2 - 44	220	100	ERG50 ERG120 WT3D
L-7-50MH-9-C	natural	208	4.7	M5	2 - 44	220	100	
L-11-50MH-0-C*	UV-resistant black	314	4.7	M5	2 - 76	220	100	
L-11-50MH-9-C*	natural	314	4.7	M5	2 - 76	220	100	
L-14-50MH-0-C	UV-resistant black	382	4.7	M5	2 - 102	220	100	ERG120 L-500-EU, WT3D
L-14-50MH-9-C	natural	382	4.7	M5	2 - 102	220	100	
L-14-120MH-0-C*	UV-resistant black	382	7.6	M6	5 - 102	540	100	
L-14-120MH-9-C*	natural	382	7.6	M6	5 - 102	540	100	

* Not UL listed

Description of materials and properties: see pages 144 to 155

For tooling specifications: see pages 130 to 143

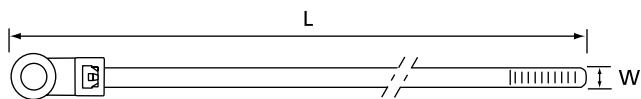

Special all-plastic cable ties

Releasable panel mounting cable ties

Characteristics

- Fastening and clip-mounting in one
- Fast pre- or on-site-assembly for a range of panel thickness up to 2.7 mm
- Fast and secure clip-mounting
- For use in 6.35 mm mounting hole
- Product References containing xxx-PMR-xxx are releasable

Technical Information

Material	Polyamide 6.6
Temperature range	-40°C to +85°C
Colour	Natural or UV-resistant black (see table)
Flammability rating	UL 94 V-2
Other properties	UV-resistant (black), Halogen free, Silicone free



Product Ref.	Colour	Length L [mm]	Width W [mm]	Bundle ø from ... to [mm]	Min. tensile strenght [N]	Quantity [pieces]	Tooling
STANDARD PANEL MOUNTING TIES							
L-5-50PM-0-C*	UV-resistant black	147	4.8	2 - 25	220	100	ERG50 ERG120 L-500-EU
L-5-50PM-9-D*	natural	147	4.8	2 - 25	220	1000	
L-7-50PM-0-C	UV-resistant black	208	4.8	2 - 44	220	100	
L-7-50PM-9-C	natural	208	4.8	2 - 44	220	100	
RELEASABLE PANEL MOUNTING TIES							
TB-4-50PMR-9-C-EU*	natural	110	4.8	2 - 22	220	100	ERG50
L-5-50PMR-0-C*	UV-resistant black	147	4.8	2 - 25	220	100	ERG120
L-5-50PMR-9-C*	natural	147	4.8	2 - 25	220	100	L-500-EU
L-7-50PMR-9-C*	natural	208	4.8	2 - 44	220	100	WT1-TB WT2-TB

* Not UL registered

Description of materials and properties: see pages 144 to 155

For tooling specifications: see pages 130 to 143

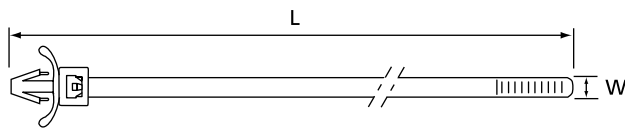

Special all-plastic cable ties

Releasable cable ties

Characteristics

- Easy releasable and re-usable. UV-resistant version, especially recommended for outdoor applications.

Technical Information

Material Polyamide 6.6
 Temperature range -40°C to +85°C
 Colour Natural or UV-resistant black (see table)
 Flammability rating UL 94 V-2
 Other properties UV-resistant (black), Halogen free, Silicone free



Product Ref.	Colour	Length	Width	Bundle ø	Min. tensile strenght [N]	Quantity [pieces]	Tooling
		L [mm]	W [mm]	from ... to [mm]			
L-5-50R-0-C*	UV-resistant black	150	7.5	3 - 32	220	100	L-500-EU WT3D ERG120
L-8-50R-0-C*	UV-resistant black	198	7.5	3 - 51	220	100	
L-8-50R-9-C*	natural	198	7.5	3 - 51	220	100	
L-10-50R-0-C	UV-resistant black	298	7.5	3 - 76	220	100	
L-10-50R-9-C	natural	298	7.5	3 - 76	220	100	

* Not UL Listed

Description of materials and properties: see pages 144 to 155
 For tooling specifications: see pages 130 to 143

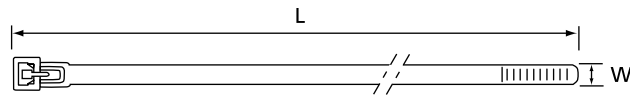

Special all-plastic cable ties

Cable ties with identification tag

Characteristics

- Identification ties with incorporated label for durable marking and tying
- Simple marking on the roughened writing surface

Technical Information

Material	Polyamide 6.6
Temperature range	-40°C to +85°C
Colour	Natural
Flammability rating	UL 94 V-2
Other properties	Halogen free, Silicone free



Product Ref.	Length L [mm]	Width W [mm]	Label dimensions [mm]	Bundle ø max. [mm]	Min. tensile strenght [N]	Quantity [pieces]	Tooling
L-4-18ID-9-C	102	2.5	7.9 x 24.7	19	80	100	ERG50
L-4-18ID-9-M	102	2.5	7.9 x 24.7	19	80	1000	
L-7-50ID-9-C	200	4.7	30 x 13.3	44	220	100	ERG50, ERG120 L-500-EU
L-7-50ID-9-M	200	4.7	30 x 13.3	44	220	1000	

Description of materials and properties: see pages 144 to 155

For tooling specifications: see pages 130 to 143

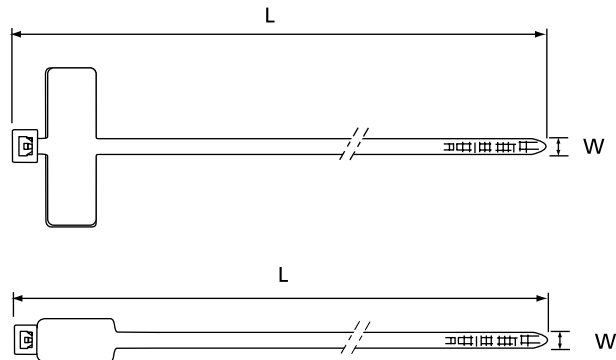

E49405

Special all-plastic cable ties

Special double-headed ties

Characteristics

- The double-headed ties allow the parallel routing of two bundles of cable with one single tie.
- Available in 3 different lengths.

Technical Information

Material	Polyamide 6.6
Temperature range	-40°C to +85°C
Colour	Natural
Flammability rating	UL 94 V-2
Other properties	Halogen free, Silicone free



Product Ref.	Length L [mm]	Width W [mm]	Bundle diameter		Min. tensile strength [N]	Quantity [pieces]	Tooling
			loop 1 from ... to [mm]	Loop 2 from ... to [mm]			
TB-50RLDH	200	4.8	2.5 - 47	2.0 - 45	220	1000	ERG50 ERG120 L-500-EU
TB-12-50RLDH	300	4.8	2.5 - 72	2.0 - 70	220	1000	
TB-15-50RLDH	370	4.8	2.5 - 100	2.0 - 97	220	1000	

Description of materials and properties: see pages 144 to 155
 For tooling specifications: see pages 130 to 143

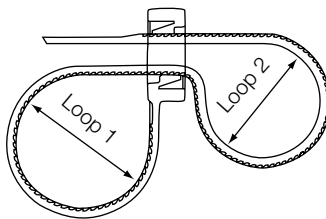
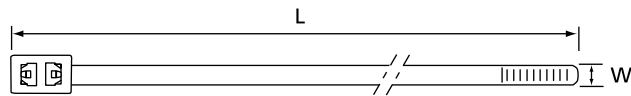

Special all-plastic cable ties

Safe-Ty™ Low profile in-line fasteners

Characteristics

The Safe-Ty™ design from ABB is ideal for use where precision bundling is required and clearance is a necessity. A unique saddle back design curves to form a snug fit around the bundle, and allows for easy pull-through in bulkheads and any other tight spaces.

- Low-profile, contoured head reduces clearance required for the bundle and enhances the appearance of your harness
- The safe-guard wall eliminates exposure to sharp edges
- The saddle back fits snug against the contour of the wiring harness
- Sizes and colours available to accommodate various requirements
- Recommended in all applications where the aesthetics and the user's safety can be a concern (thanks to the rounded edges): playgrounds, supermarket displays,...

Technical Information

Material	Polyamide 6.6
Temperature range	-40°C to +85°C
Colour	Natural or UV-resistant (see table)
Flammability rating	UL 94 V-2
Other properties	UV-resistant (black), Halogen free, Silicone free



Product Ref.	Colour	Length		Width		D	Bundle ø from ... to [mm]	Min. tensile strength [N]	Quantity ** [pieces]	Tooling
		L [mm]	W [mm]	L [mm]	W [mm]					
SF100-18	natural*	118	2.4	3.2	3.2	3.2 - 25.4	80	100 / 1000	ERG50	
SF100-18X	UV-resistant black	118	2.4	3.2	3.2	3.2 - 25.4	80	100 / 1000		
SF200-18	natural*	206	2.4	3.2	3.2	3.2 - 50.8	80	100 / 1000		
SF200-18X	UV-resistant black	206	2.4	3.2	3.2	3.2 - 50.8	80	100 / 1000		
SF175-50	natural*	201	4.7	4.5	4.7	4.7 - 44.5	220	100 / 1000	ERG50 ERG120 L-500-EU	
SF175-50X	UV-resistant black	201	4.7	4.5	4.7	4.7 - 44.5	220	100 / 1000		
SF300-50	natural*	288	4.7	4.5	4.7	4.7 - 76.2	220	100 / 1000		
SF300-50X	UV-resistant black	288	4.7	4.5	4.7	4.7 - 76.2	220	100 / 1000		

* For other colours add colour suffix to Product Reference: 0 = black, 1 = brown, 2 = red, 3 = orange, 4 = yellow, 5 = green, 6 = blue, 8 = grey and 9 = white. For example: SF175-50-2 (red)



** Standard quantity = 1000. For bags of 100 add -100 to the product reference, for example. SF100-18-100.

Description of materials and properties: see pages 144 to 155

For tooling specifications: see pages 130 to 143

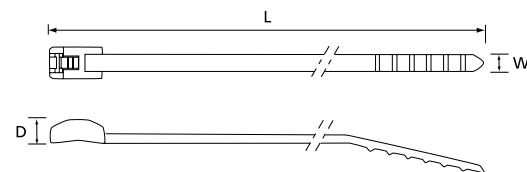

Note: Nylon (Polyamide) is inherently susceptible to environmental conditions. Safe-Ty™ cable ties are moisturised to optimum performance levels at machine-side and should be stored in cool dry areas out of direct sunlight. Cable ties are packaged in plastic bags to contain moisture and should remain sealed until ready for use

Special cable ties

Ty-Grip™ Hook & Loop fasteners

Characteristics

These handy ties are very easy to release and re-use, making them ideal for applications where changes are anticipated or continuous access is required.

- Quick bundling and re-adjustable tension
- No risk of over-tightening the cables, which makes the Ty-Grip™ Hook & Loop fasteners ideal for specific applications in fibre optics, computer network wiring, telecom cables, etc.
- Multiple colours available for identifying specific bundles
- Different sizes available to accommodate varying bundle diameters
- Screw-mount and self-adhesive mounting bases provide multiple mounting options

Technical Information FO Series

Material hook side	Polyamide
Material loop side	Low density Polyethylene
Temperature range	-20°C to +104°C
Colour	Standard colour: black
Flammability rating	UL 94 HB*
Peel-off strength	0.8N/cm

Technical Information FOL Series

Material hook side	Polyamide
Temperature range	-20°C to +93°C
Colour	Standard colour: black - see note after table
Flammability rating	UL 94 HB
Peel-off strength	0.8N/cm



FO series loop ties are ideal for wrapping pre-determined bundle diameters thanks to the convenient slotted head.



FOL series buckle ties provide added strength and stability thanks to the high performance polyamide buckle.

Product Ref.	Maximum bundle diameter [mm]	Length L [mm]	Width W [mm]	Tensile strength [N]	Quantity [pieces]
FO SERIES LOOP TIES					
F0200-40-0	50.8	228.6	12.7	180	10
F0200-50-0	50.8	228.6	19.1	220	10
F0350-40-0	88.9	330.2	12.7	180	10
F0350-50-0	88.9	330.2	19.1	220	10
F0350-50-0-FR*	88.9	330.2	19.1	220	10
FOL SERIES BUCKLE TIES					
FOL300-50-0	76.2	304.8	19.1	220	10
FOL500-50-0	127.0	457.2	19.1	220	10

Replace "-0" in the Product Reference by the corresponding colour code: 1 = brown, 2 = red, 3 = orange, 4 = yellow, 5 = green, 6 = blue, 8 = grey and 9 = white



* Suffix FR is Flame Retardant version

Special cable ties

Ty-Grip™ Hook & Loop fasteners

Characteristics

These handy ties are very easy to release and re-use, making them ideal for applications where changes are anticipated or continuous access is required.

- Quick bundling and re-adjustable tension
- No risk of over-tightening the cables, which makes the Ty-Grip™ Hook & Loop fasteners ideal for specific applications in fibre optics, computer network wiring, telecom cables, etc.
- Multiple colours available for identifying specific bundles
- Different sizes available to accommodate varying bundle diameters
- Screw-mount and self-adhesive mounting bases provide multiple mounting options

Technical Information FOS and FOR Series

Material hook side	Polyamide
Material loop side	Low density Polyethylene
Temperature range	-20°C to +104°C
Colour	Standard colour: black*
Flammability rating	UL 94 HB
Peel-off strength	0.8N/cm



FOS series strip ties are pre-cut which makes bundling easy.



FOR series rolled hook and loop allows customers to conveniently cut pieces to desired lengths, eliminating waste.

Product Ref.	Maximum bundle diameter [mm]	Length L [mm]	Width W [mm]	Tensile strenght [N]	Quantity [pieces]
FOS SERIES STRIP TIES					
FOS150-50-0	38.1	152.4	19.1	220	10
FOS320-50-0	81.3	304.8	19.1	220	10
FOS500-50-0	127.0	457.2	19.1	220	10
FOR SERIES ROLLED STRIP					
FOR180-50-0	Various	4572.0	19.1	220	1
FOR180-50-0-FR**	Various	4572.0	19.1	220	1

* Standard colour: black

Replace "-0" in the Product Reference by the corresponding colour code: 1 = brown, 2 = red, 3 = orange, 4 = yellow, 5 = green, 6 = blue, 8 = grey and 9 = white

For example: FOS150-50-2 defines a red FOS150-50 type fastener



** FOR180-50-0-FR is made of flame retardant material

Contact your Sales Office for Product Availability in the other colours

Polyamide 6.6 Twist Tail® cable tie

All plastic cable tie – no tool needed

Characteristics

- New all-plastic cable tie, with unique patent design
- Quick and easy to install, no tools required
- Strong, made of Polyamide 6.6, with 130N minimum tensile strength
- Safe, tail breaks off neat and clean, with no sharp edges
- General purpose applications, indoor and outdoor
- Available in 3 different lengths and 2 colours (white and UV-resistant black)

Technical Information

Material	Polyamide 6.6
Min. Installation Temp.	0°C
Max. Installation Temp.	+85°C
Colour	White or UV-resistant black
Flammability rating	UL 94 V-2
Other properties	Halogen free, Silicone free



Product Ref.	Colour	Length [mm]	Width [mm]	Thickness [mm]	Bundle diameter [mm]	Quantity [pieces]
TT-7-30-9-L-EU	white	181	4.7	1.4	45	50
TT-7-30-0-L-EU	black	181	4.7	1.4	45	50
TT-11-30-9-L-EU	white	282	4.7	1.4	76	50
TT-11-30-0-L-EU	black	282	4.7	1.4	76	50
TT-14-30-9-L-EU	white	358	4.7	1.4	102	50
TT-14-30-0-L-EU	black	358	4.7	1.4	102	50

Col-Ty™ Heavy-duty double headed installation ties

Heavy-duty installation ties

Characteristics

- For securing and bundling of cables in the utility and construction industries
- Low profile double locking head*
- Serrations on the outer side of the tie eliminates the risk of damage to the cable
- Ideal for hazardous environments, low temperatures and humidity

Technical Information

Material	Polyester
Temperature range	-40°C to +80°C
Colour	Black
Flammability rating	UL 94 HB
Other properties	UV-resistant

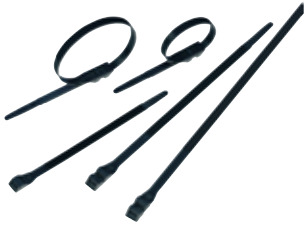

Product Ref.	Length L [mm]	Width W [mm]	Thickness [mm]	Bundle ø from ... to [mm]	Min. tensile strenght [N]	Quantity [pieces]	Tooling
CTP-9-180-0-C*	180	9	1.8	10 - 42	320	100	L300-FR L-500-EU WT3D
CTP-9-260-0-C	260	9	2.0	15 - 62	500	100	
CTP-9-360-0-C	360	9	2.0	25 - 92	500	100	
CTP-9-500-0-C	510	9	2.4	74 - 140	600	100	
CTP-9-750-0-C	760	9	2.4	74 - 220	600	100	

* Product Ref. CTP-9-180-0-C has a single locking head

Description of materials and properties: see pages 144 to 155

For tooling specifications: see pages 130 to 143

Double locking head

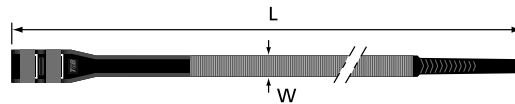

Single locking head

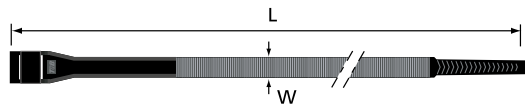

Col-Ty™ Accessories

Heavy-duty installation ties

Characteristics

- Use 5 mm screw
- Cradle for ties up to 9 mm wide

Technical Information

Material	Polyamide 11/12
Temperature range	-40°C to +80°C
Colour	Black
Flammability rating	UL 94 HB
Other properties	UV-resistant



Product Réf.	L [mm]	I [mm]	S [mm]	H [mm]	F [mm]	d2 [mm]	Quantity [pieces]
CT-3401	22.9	10.5	17.6	13.8	9.4	5.9	100

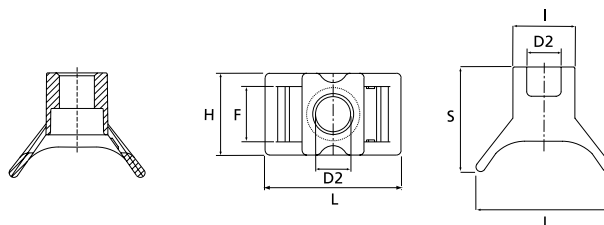

Col-Ty™ Accessories

Heavy-duty installation ties

Characteristics

- Wall plug suitable for \varnothing 8 mm hole
- Simply drill hole and hammer the plug in

Technical Information

Material	Polyamide 11/12
Temperature range	-40°C to +80°C
Colour	Black
Flammability rating	UL 94 HB
Other properties	UV-resistant



Product Réf.	L [mm]	Ød1 [mm]	S [mm]	H [mm]	I [mm]	F [mm]	f [mm]	Quantity [pieces]
CT-5359	43.1	9.6	13.2	16	6.3	9.5	2.4	100

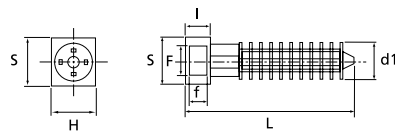

Spec-Kon® cable ties

The right cable tie for the right application

Characteristics

A complete range of cable ties for control panel applications.

- Available in different packaging quantities to respond to the user's need
- Available in different lengths and tensile strengths
- Sophisticated, ergonomic fastening installation tools and easy to use cable ties dispenser

Technical Information

Material	Polyamide 6.6
Temperature range	-40°C to +85°C
Colour	Natural
Flammability rating	UL 94 V-2
Other properties	Halogen free, Silicone free



Product Ref.	Length L [mm]	Width W [mm]	Min. tensile strength [N]	Bundle diameter from... to... [mm]	Quantity [pieces]	Bags/ Carton
SKT100-80-100	100	2,5	80	1.5 - 22	100	550
SKT100-80	100	2,5	80	1.5 - 22	1000	70
SKT140-80-100	140	2,5	80	1.5 - 33	100	450
SKT140-80	140	2,5	80	1.5 - 33	1000	55
SKT160-80-100	160	2,5	80	1.5 - 40	100	400
SKT160-80	160	2,5	80	1.5 - 40	1000	45
SKT200-80-100	200	2,5	80	1.5 - 53	100	300
SKT200-80	200	2,5	80	1.5 - 53	1000	32
SKT140-180-100	140	3,6	180	2 - 33	100	300
SKT140-180	140	3,6	180	2 - 33	1000	30
SKT200-180-100	200	3,6	180	2 - 53	100	200
SKT200-180	200	3,6	180	2 - 53	1000	22
SKT300-180-100	300	3,6	180	2 - 76	100	120
SKT300-180	300	3,6	180	2 - 76	1000	12
SKT370-180-100	370	3,6	180	2 - 102	100	120
SKT370-180	370	3,6	180	2 - 102	1000	12
SKT188-220-100	188	4,8	220	3 - 46	100	160
SKT188-220	188	4,8	220	3 - 46	1000	16
SKT215-220-100	215	4,8	220	3 - 53	100	11
SKT215-220	215	4,8	220	3 - 53	1000	13
SKT250-220-100	250	4,8	220	3 - 60	100	120
SKT250-220	250	4,8	220	3 - 60	1000	12
SKT300-220-100	300	4,8	220	3 - 76	100	80
SKT300-220	300	4,8	220	3 - 76	1000	8
SKT370-220-100	370	4,8	220	3 - 102	100	70
SKT370-220	370	4,8	220	3 - 102	1000	7
SKT300-540-100	300	7,6	540	7 - 76	100	50
SKT300-540	300	7,6	540	7 - 76	500	10
SKT370-540-100	370	7,6	540	7 - 102	100	40
SKT370-540	370	7,6	540	7 - 102	500	8
SKT450-540-50	450	7,6	540	7 - 142	50	50
SKT750-540-50	750	7,6	540	7 - 218	50	30
SKT776-780-50	776	9,0	780	7 - 228	50	30
SKT912-780-50	912	9,0	780	7 - 263	50	10

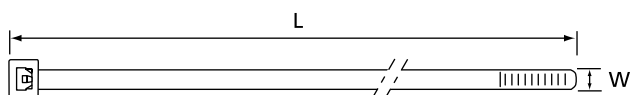

Spec-Kon® cable ties

The right cable tie for the right application

Characteristics

A complete range of cable ties for control panel applications.

- Available in different packaging quantities to respond to the user's need
- Available in different lengths and tensile strengths
- Sophisticated, ergonomic fastening installation tools and easy to use cable ties dispenser

Technical Information

Material	Polyamide 6.6
Temperature range	-40°C to +85°C
Colour	UV-resistant black
Flammability rating	UL 94 V-2
Other properties	UV-resistant, Halogen free, Silicone free



Product Ref.	Length L [mm]	Width W [mm]	Min. tensile strength [N]	Bundle diameter from... to... [mm]	Quantity [pieces]	Bags/ Carton
SKT100-80X-100	100	2,5	80	1.5 - 22	100	550
SKT100-80X	100	2,5	80	1.5 - 22	1000	70
SKT140-80X-100	140	2,5	80	1.5 - 33	100	450
SKT140-80X	140	2,5	80	1.5 - 33	1000	55
SKT160-80X-100	160	2,5	80	1.5 - 40	100	400
SKT160-80X	160	2,5	80	1.5 - 40	1000	45
SKT200-80X-100	200	2,5	80	1.5 - 53	100	300
SKT200-80X	200	2,5	80	1.5 - 53	1000	32
SKT140-180X-100	140	3,6	180	2 - 33	100	300
SKT140-180X	140	3,6	180	2 - 33	1000	30
SKT200-180X-100	200	3,6	180	2 - 53	100	200
SKT200-180X	200	3,6	180	2 - 53	1000	22
SKT300-180X-100	300	3,6	180	2 - 76	100	120
SKT300-180X	300	3,6	180	2 - 76	1000	12
SKT370-180X-100	370	3,6	180	2 - 102	100	120
SKT370-180X	370	3,6	180	2 - 102	1000	12
SKT188-220X-100	188	4,8	220	3 - 46	100	160
SKT188-220X	188	4,8	220	3 - 46	1000	16
SKT215-220X-100	215	4,8	220	3 - 53	100	11
SKT215-220X	215	4,8	220	3 - 53	1000	13
SKT250-220X-100	250	4,8	220	3 - 60	100	120
SKT250-220X	250	4,8	220	3 - 60	1000	12
SKT300-220X-100	300	4,8	220	3 - 76	100	80
SKT300-220X	300	4,8	220	3 - 76	1000	8
SKT370-220X-100	370	4,8	220	3 - 102	100	70
SKT370-220X	370	4,8	220	3 - 102	1000	7
SKT300-540X-100	300	7,6	540	7 - 76	100	50
SKT300-540X	300	7,6	540	7 - 76	500	10
SKT370-540X-100	370	7,6	540	7 - 102	100	40
SKT370-540X	370	7,6	540	7 - 102	500	8
SKT450-540X-50	450	7,6	540	7 - 142	50	50
SKT750-540X-50	750	7,6	540	7 - 218	50	30
SKT776-780X-50	776	9,0	780	7 - 228	50	30
SKT912-780X-50	912	9,0	780	7 - 263	50	10

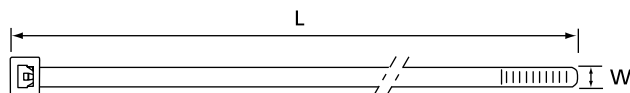

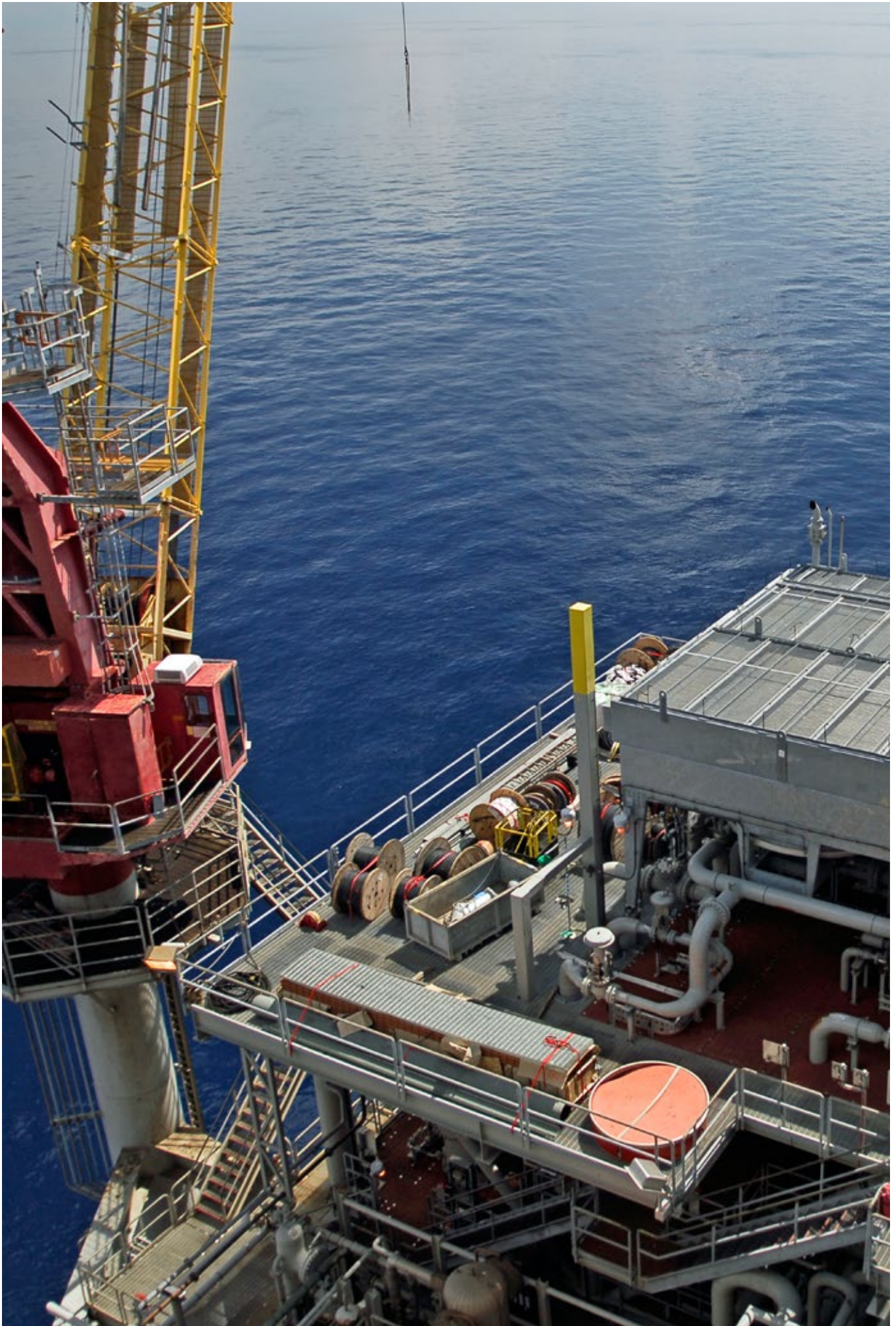

Table of Content

Stainless steel cable ties

Ty-Rap® High Performance Cable Ties	2
All-plastic cable ties	42
Stainless steel cable ties	66
Features & Benefits	70
Ball-Lock Type - Standard widths, uncoated	72
Ball-Lock Type - Standard widths, fully coated	73
Ball-Lock Type - Heavy duty ties, uncoated	74
Ball-Lock Type - Heavy duty ties, fully coated	75
Ladder Type - uncoated	76
Ladder Type - fully coated	77
Strap Type ties	78
Releasable Type	79
Stainless steel ID system	80
Bands on reel with separate heads	81
Mounting bases	82
Selection chart & specifications	83
Mounting bases and accessories	84
Cable protection systems	120
Cable tie tooling	130
Material specifications	144

Ty-Met™ Stainless steel cable ties

Introduction



Ty-Met™ Stainless Steel cable ties

Stainless steel cable ties

The Ty-Met™ stainless steel ties are the ultimate solution to install your cables in extreme conditions and hazardous areas, indoor and outdoor, such as the petrochemical and food processing industries, power stations, mining, shipbuilding, offshore and other aggressive environments.

Ty-Met™

The Ty-Met™ stainless steel ties provide a high mechanical strength combined with chemical durability and temperature resistance.

They are available in several different types:

- Ball-Lock Type: quick and reliable self-locking mechanism
- Ladder Type: easy application and strong locking system
- Strap Type: either pre-assembled or on reel with separate heads
- Releasable Type: can be unfastened for re-use
- Identification System: durable in tough environments and extreme conditions
- Band on reel with separate heads, for a cost saving installation without waste

Ty-Met™ cable ties have international approvals such as UL, Germanischer Lloyd, Lloyd's Register and Det Norske Veritas. All types are available in 316 grade (marine grade) stainless steel, for extra corrosionresistance

Available in uncoated version (for high temperature applications) or in fully coated version with non-toxic, halogen free coating, for a superior protection of cables and installer's hands and for an improved insulation between dissimilar materials.

A range of dedicated hand tools completes the product offering.

Ty-Met™ Stainless steel cable ties

Features and Benefits

Ball-Lock Type

Easy application and strong self-locking mechanism (steel ball), with low insertion force

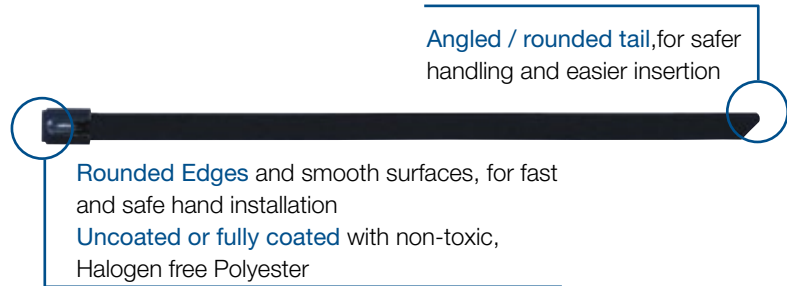

Ladder Type

Self-locking mechanism (pawl and ratchet)

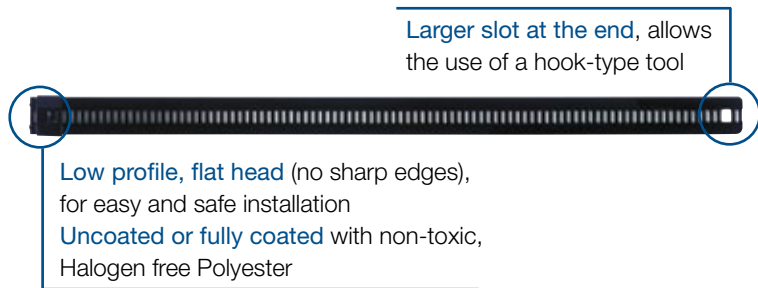

Releasable Type

The unique buckle design allows the tie to be unfastened for re-use

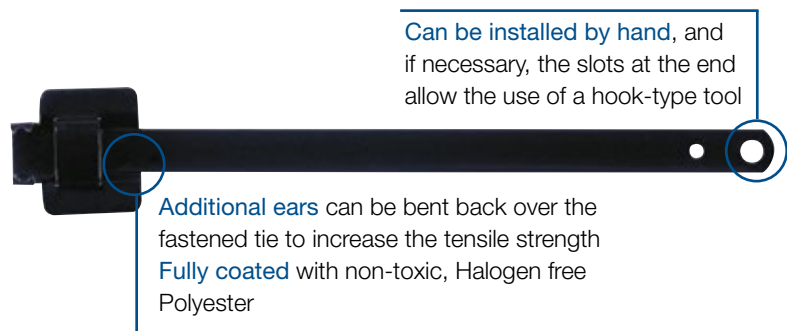

UV-resistant



Heat resistant



Low temperature flexibility



Weather-proof



Flame retardant



Chemically resistant



Radiation resistant

ID System

Durable identification system for tough environments and extreme conditions, indoor and outdoor

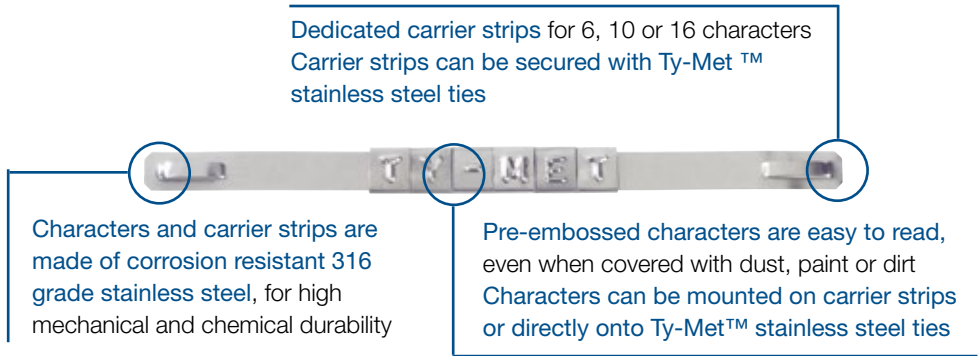

Bands on Reel with Separate Heads

Bands and separate heads are made of corrosion resistant 316 grade stainless steel, for high mechanical and chemical durability

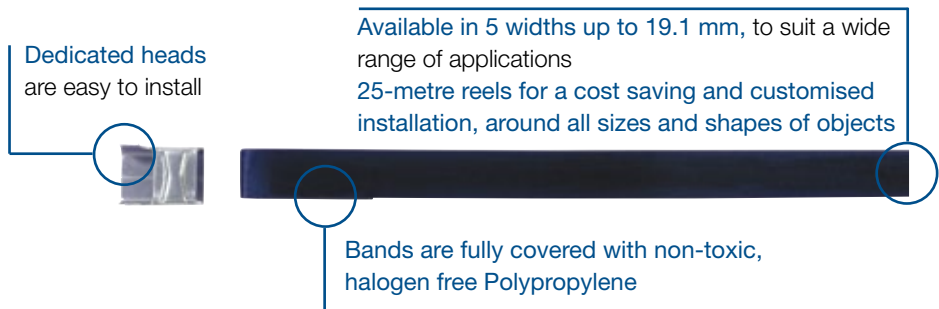

Ty-Met™ Stainless steel cable ties

Ball-Lock Type – Standard widths, uncoated

Characteristics

The Ball-Lock Type stainless steel ties from ABB are self-locking, requiring no time consuming crimping or folding operations.

- Strong self-locking mechanism (stainless steel ball), with low insertion force
- Fast, easy and reliable installation
- Standard widths (4.6 mm & 7.9 mm), suitable for most applications, indoor and outdoor
- Uncoated version, suitable for high temperature environments
- 2 grades of non-magnetic stainless steel: 304 grade for standard applications and 316 grade (marine grade) for extra corrosion resistance
- Applications: installation of cables and pipes in extreme conditions and hazardous areas, such as: petrochemical and food processing industries, power stations, mining, shipbuilding, offshore and other aggressive environments

Technical Information

Material	A. 304 grade non-magnetic stainless steel B. 316 grade non-magnetic stainless steel
Temperature range	-40°C to +300°C
Colour	Metallic
Flammability rating	Absolutely fireproof
Other properties	UV-resistant



Product Ref. Stainless steel 304	Product Ref. Stainless steel 316	Length L [mm]	Width W [mm]	Material thickness [mm]	Bundle ø from... to [mm]	Min. tensile strenght [N]	Quantity [pieces]	Tooling
YLS-4.6-100A	YLS-4.6-100B	100	4.6	0.26	20-25	778	100	
YLS-4.6-125A	YLS-4.6-125B	125	4.6	0.26	20-25	778	100	
YLS-4.6-150A	YLS-4.6-150B	150	4.6	0.26	20-35	778	100	
YLS4.6-200A	YLS4.6-200B	200	4.6	0.26	20-50	778	100	
YLS-4.6-300A	YLS-4.6-300B	300	4.6	0.26	20-83	778	100	
YLS4.6-360A	YLS4.6-360B	360	4.6	0.26	20-100	778	100	
YLS4.6-520A	YLS-4.6-520B	520	4.6	0.26	20-150	778	100	
YLS-4.6-680A	YLS-4.6-680B	680	4.6	0.26	20-200	778	100	
YLS-4.6-840A	YLS-4.6-840B	840	4.6	0.26	20-250	778	100	
YLS-4.6-1000A	YLS-4.6-1000B	1000	4.6	0.26	20-300	778	100	
YLS-4.6-1200A	YLS-4.6-1200B	1200	4.6	0.26	20-365	778	100	
YLS-4.6-1400A	YLS-4.6-1400B	1400	4.6	0.26	20-425	778	100	
YLS-7.9-100A	YLS-7.9-100B	100	7.9	0.26	20-20	1112	100	CT3 CT6
YLS-7.9-125A	YLS-7.9-125B	125	7.9	0.26	20-22	1112	100	
YLS-7.9-150A	YLS-7.9-150B	150	7.9	0.26	20-35	1112	100	
YLS7.9-200A	YLS-7.9-200B	200	7.9	0.26	20-50	1112	100	
YLS-7.9-300A	YLS-7.9-300B	300	7.9	0.26	20-83	1112	100	
YLS7.9-360A	YLS-7.9-360B	360	7.9	0.26	20-100	1112	100	
YLS7.9-520A	YLS-7.9-520B	520	7.9	0.26	20-150	1112	100	
YLS-7.9-680A	YLS-7.9-680B	680	7.9	0.26	20-200	1112	100	
YLS-7.9-840A	YLS-7.9-840B	840	7.9	0.26	20-250	1112	100	
YLS-7.9-1000A	YLS-7.9-1000B	1000	7.9	0.26	20-300	1112	100	
YLS-7.9-1200A	YLS-7.9-1200B	1200	7.9	0.26	20-365	1112	100	
YLS-7.9-1400A	YLS-7.9-1400B	1400	7.9	0.26	20-425	1112	100	

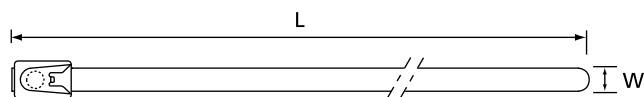

* Some approvals may not be applicable to all the Product References. Contact your Sales Office for approvals limitations

Ty-Met™ Stainless steel cable ties

Ball-Lock Type – Standard widths, fully coated

Characteristics

The Ball-Lock Type stainless steel ties from ABB are self-locking, requiring no time consuming crimping or folding operations.

- Strong self-locking mechanism (stainless steel ball), with low insertion force
- Fast, easy and reliable installation
- Standard widths (4.6 mm & 7.9 mm), suitable for most applications, indoor and outdoor
- Corrosion resistant 316 grade stainless steel (marine grade) for high mechanical and chemical durability
- Fully coated version with non-toxic, halogen free Polyester coating, for a superior protection of cables and installer's hands and for an improved insulation between dissimilar materials.
- Applications: installation of cables and pipes in extreme conditions and hazardous areas, such as: petrochemical and food processing industries, power stations, mining, shipbuilding, offshore and other aggressive environments

Technical Information

Material	316 grade non-magnetic stainless steel
Coating	Polyester
Temperature range	-40°C to +165°C
Colour	Black
Flammability rating	Absolutely fireproof
Other properties	UV-resistant, Halogen free, non toxic



Product Ref.	Length L [mm]	Width W [mm]	Material thickness [mm]	Bundle ø from... to [mm]	Min. tensile strenght [N]	Quantity [pieces]	Tooling
YLS-4.6-100BC	100	4.6	0.36	20-25	778	100	CT3 CT6
YLS-4.6-125BC	125	4.6	0.36	20-25	778	100	
YLS4.6-150BC	150	4.6	0.36	20-35	778	100	
YLS-4.6-200BC	200	4.6	0.36	20-50	778	100	
YLS-4.6-300BC	300	4.6	0.36	20-83	778	100	
YLS-4.6-360BC	360	4.6	0.36	20-100	778	100	
YLS-4.6-520BC	520	4.6	0.36	20-150	778	100	
YLS-4.6-680BC	680	4.6	0.36	20-200	778	100	
YLS-4.6-840BC	840	4.6	0.36	20-250	778	100	
YLS-4.6-1000BC	1000	4.6	0.36	20-300	778	100	
YLS-4.6-1200BC	1200	4.6	0.36	20-365	778	100	
YLS-4.6-1400BC	1400	4.6	0.36	20-425	778	100	
YLS-7.9-100BC	100	7.9	0.36	20-20	1112	100	
YLS-7.9-125BC	125	7.9	0.36	20-22	1112	100	
YLS-7.9-150BC	150	7.9	0.36	20-35	1112	100	
YLS-7.9-200BC	200	7.9	0.36	20-50	1112	100	
YLS-7.9-300BC	300	7.9	0.36	20-83	1112	100	
YLS-7.9-360BC	360	7.9	0.36	20-100	1112	100	
YLS-7.9-520BC	520	7.9	0.36	20-150	1112	100	
YLS-7.9-680BC	680	7.9	0.36	20-200	1112	100	
YLS-7.9-840BC	840	7.9	0.36	20-250	1112	100	
YLS-7.9-1000BC	1000	7.9	0.36	20-300	1112	100	
YLS-7.9-1200BC	1200	7.9	0.36	20-365	1112	100	
YLS-7.9-1400BC	1400	7.9	0.36	20-425	1112	100	

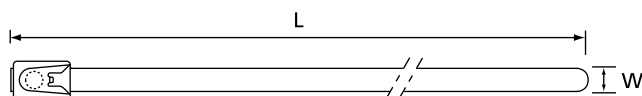

* Some approvals may not be applicable to all the Product References. Contact your Sales Office for approvals limitations

Ty-Met™ Stainless steel cable ties

Ball-Lock Type – Heavy-duty ties, uncoated

Characteristics

The Ball-Lock Type stainless steel ties from ABB are self-locking, requiring no time consuming crimping or folding operations.

- Strong self-locking mechanism (stainless steel ball), with low insertion force
- Fast, easy and reliable installation
- Heavy-duty version (12 mm & 16 mm of width), for extreme applications, indoor and outdoor
- Uncoated version, suitable for high temperature environments
- Corrosion resistant 316 grade stainless steel (marine grade) for high mechanical and chemical durability
- Applications: installation of cables and pipes in extreme conditions and hazardous areas, such as: petrochemical and food processing industries, power stations, mining, shipbuilding, offshore and other aggressive environments

Technical Information

Material	316 grade non-magnetic stainless steel
Temperature range	-40°C to +300°C
Colour	Metallic
Flammability rating	Absolutely fireproof
Other properties	UV-resistant



Product Ref.	Length L [mm]	Width W [mm]	Material thickness [mm]	Bundle ø from... to [mm]	Min. tensile strenght [N]	Quantity [pieces]	Tooling
YLS-12-200B	200	12.0	0.32	25-50	1117	50	CT3 CT7
YLS-12-300B	300	12.0	0.32	25-83	1117	50	
YLS-12-360B	360	12.0	0.32	25-100	1117	50	
YLS-12-440B	440	12.0	0.32	25-125	1117	50	
YLS-12-520B	520	12.0	0.32	25-150	1117	50	
YLS-12-600B	600	12.0	0.32	25-175	1117	50	
YLS-12-680B	680	12.0	0.32	25-200	1117	50	
YLS-12-760B	760	12.0	0.32	25-225	1117	50	
YLS-12-840B	840	12.0	0.32	25-250	1117	50	
YLS-12-1000B	1000	12.0	0.32	25-300	1117	25	
YLS-12-1200B	1200	12.0	0.32	25-365	1117	25	
YLS-12-1400B	1400	12.0	0.32	25-425	1117	25	
YLS-16-200B	200	16.0	0.32	40-50	4005	50	CT7
YLS-16-300B	300	16.0	0.32	40-80	4005	50	
YLS-16-360B	360	16.0	0.32	40-100	4005	50	
YLS-16-440B	440	16.0	0.32	40-125	4005	50	
YLS-16-520B	520	16.0	0.32	40-150	4005	50	
YLS-16-600B	600	16.0	0.32	40-185	4005	50	
YLS-16-680B	680	16.0	0.32	40-200	4005	50	
YLS-16-760B	760	16.0	0.32	40-225	4005	50	
YLS-16-840B	840	16.0	0.32	40-250	4005	50	
YLS-16-1000B	1000	16.0	0.32	40-300	4005	25	
YLS-16-1200B	1200	16.0	0.32	40-365	4005	25	
YLS-16-1400B	1400	16.0	0.32	40-425	4005	25	

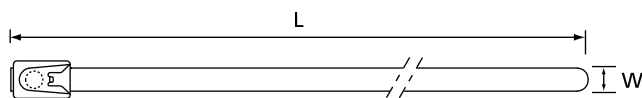

* Some approvals may not be applicable to all the Product References. Contact your Sales Office for approvals limitations

Ty-Met™ Stainless steel cable ties

Ball-Lock Type – Heavy-duty ties, fully coated

Characteristics

The Ball-Lock Type stainless steel ties from ABB are self-locking, requiring no time consuming crimping or folding operations.

- Strong self-locking mechanism (stainless steel ball), with low insertion force
- Fast, easy and reliable installation
- Heavy-duty version (12 mm & 16 mm of width), for extreme applications, indoor and outdoor
- Corrosion resistant 316 grade stainless steel (marine grade) for high mechanical and chemical durability
- Fully coated version with non-toxic, halogen free Polyester coating, for a superior protection of cables and installer's hands and for an improved insulation between dissimilar materials.
- Applications: installation of cables and pipes in extreme conditions and hazardous areas, such as: petrochemical and food processing industries, power stations, mining, shipbuilding, offshore and other aggressive environments

Technical Information

Material	316 grade non-magnetic stainless steel
Coating	Black Polyester
Temperature range	-40°C to +165°C
Flammability rating	Absolutely fireproof
Other properties	UV-resistant, Halogen free, non toxic



Product Ref.	Length L [mm]	Width W [mm]	Material thickness [mm]	Bundle ø from... to [mm]	Min. tensile strenght [N]	Quantity [pieces]	Tooling
YLS-12-200BC	200	12.0	0.42	25-50	1335	50	CT3 CT7
YLS-12-300BC	300	12.0	0.42	25-83	1335	50	
YLS-12-360BC	360	12.0	0.42	25-100	1335	50	
YLS-12-440BC	440	12.0	0.42	25-125	1335	50	
YLS-12-520BC	520	12.0	0.42	25-150	1335	50	
YLS-12-600BC	600	12.0	0.42	25-175	1335	50	
YLS-12-680BC	680	12.0	0.42	25-200	1335	50	
YLS-12-760BC	760	12.0	0.42	25-225	1335	50	
YLS-12-840BC	840	12.0	0.42	25-250	1335	50	
YLS-12-1000BC	1000	12.0	0.42	25-300	1335	25	
YLS-12-1200BC	1200	12.0	0.42	25-365	1335	25	
YLS-12-1400BC	1400	12.0	0.42	25-425	1335	25	
YLS-16-200BC	200	16.0	0.42	40-50	2002	50	CT7
YLS-16-300BC	300	16.0	0.42	40-80	2002	50	
YLS-16-360BC	360	16.0	0.42	40-100	2002	50	
YLS-16-440BC	440	16.0	0.42	40-125	2002	50	
YLS-16-520BC	520	16.0	0.42	40-150	2002	50	
YLS-16-600BC	600	16.0	0.42	40-185	2002	50	
YLS-16-680BC	680	16.0	0.42	40-200	2002	50	
YLS-16-760BC	760	16.0	0.42	40-225	2002	50	
YLS-16-840BC	840	16.0	0.42	40-250	2002	50	
YLS-16-1000BC	1000	16.0	0.42	40-300	2002	25	
YLS-16-1200BC	1200	16.0	0.42	40-365	2002	25	
YLS-16-1400BC	1400	16.0	0.42	40-425	2002	25	

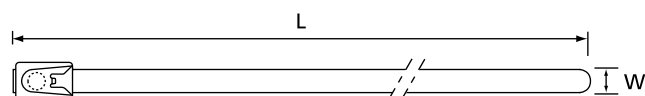

Ty-Met™ Stainless steel cable ties

Ladder Type – Uncoated

Characteristics

The Ladder Type stainless steel ties from ABB have a flat, low profile head for easy application.

- Strong self-locking mechanism (pawl and ratchet), requires no time consuming crimping or folding operations
- Flat and low profile head (no sharp edge), for easy installation
- Corrosion resistant 316 grade stainless steel for high mechanical and chemical durability
- Uncoated version for high temperature applications
- Increased usable length (slots up to the end of the tail), allows larger bundle diameters with the same tie length
- Larger slot at the end, allows the use of a hook-type tool
- Applications: Installation of cables and pipes in extreme conditions and hazardous areas, indoor and outdoor, such as: petrochemical and food processing industries, power stations, mining, shipbuilding, offshore and other aggressive environments

Technical Information

Material	316 grade stainless steel
Coating	Uncoated
Temperature range	-40°C to +300°C
Colour	Metallic
Flammability rating	Absolutely fireproof
Other properties	UV-resistant



Product Ref.	Length L [mm]	Width W [mm]	Material thickness [mm]	Bundle ø from... to [mm]	Min. tensile strength [N]	Quantity [pieces]	Tooling
YLD-7-150-B	150	7.0	0.30	20-45	529	100	CT1-TB CT2-TB CT3 CT4-TB CT5 WT3S
YLD-7-225-B	225	7.0	0.30	20-70	529	100	
YLD-7-300-B	300	7.0	0.30	20-95	529	100	
YLD-7-450-B	450	7.0	0.30	20-140	529	100	
YLD-7-610-B	610	7.0	0.30	20-190	529	100	
YLD-12-150-B	150	12.0	0.35	20-43	529	100	
YLD-12-225-B	225	12.0	0.35	20-60	529	100	
YLD-12-300-B	300	12.0	0.35	20-80	529	100	
YLD-12-450-B	450	12.0	0.35	20-135	529	100	
YLD-12-610-B	610	12.0	0.35	20-185	529	100	

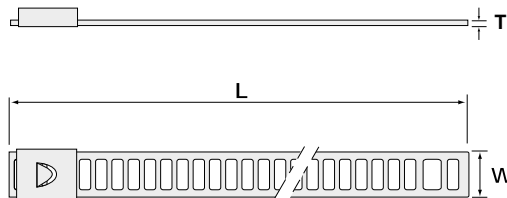

* Some approvals may not be applicable to all the Product References. Contact your Sales Office for approvals limitations

Ty-Met™ Stainless steel cable ties

Ladder Type – Fully coated

Characteristics

The Ladder Type stainless steel ties from ABB have a flat, low profile head for easy application.

- Strong self-locking mechanism (pawl and ratchet), requires no time consuming crimping or folding operations
- Flat and low profile head (no sharp edge), for easy installation
- Corrosion resistant 316 grade stainless steel for high mechanical and chemical durability
- Fully coated version with non-toxic, Halogen free Polyester coating, for a superior protection of cables and installer's hands and for an improved insulation between dissimilar materials
- Increased usable length (slots up to the end of the tail), allows larger bundle diameters with the same tie length
- Larger slot at the end, allows the use of a hook-type tool
- Applications: Installation of cables and pipes in extreme conditions and hazardous areas, indoor and outdoor, such as: petrochemical and food processing industries, power stations, mining, shipbuilding, offshore and other aggressive environments

Technical Information

Material	316 grade stainless steel
Coating	Polyester
Temperature range	-60°C to +165°C
Colour	Black
Flammability rating	Absolutely fireproof
Other properties	UV-resistant, Halogen free, non-toxic



Product Ref.	Length L [mm]	Width W [mm]	Material thickness [mm]	Bundle ø from... to [mm]	Min. tensile strength [N]	Quantity [pieces]	Tooling
YLD-7-150-BC	150	7.0	0.41	20-45	778	100	CT1-TB CT2-TB CT3 CT4-TB CT5 WT3S
YLD-7-225-BC	225	7.0	0.41	20-70	778	100	
YLD-7-300-BC	300	7.0	0.41	20-95	778	100	
YLD-7-450-BC	450	7.0	0.41	20-140	778	100	
YLD-7-610-BC	610	7.0	0.41	20-190	778	100	
YLD-12-150-BC	150	12.0	0.46	20-43	778	100	
YLD-12-225-BC	225	12.0	0.46	20-60	778	100	
YLD-12-300-BC	300	12.0	0.46	20-80	778	100	
YLD-12-450-BC	450	12.0	0.46	20-135	778	100	
YLD-12-610-BC	610	12.0	0.46	20-185	778	100	

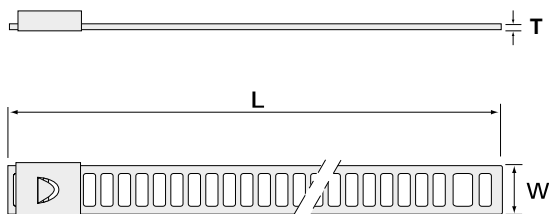

* Some approvals may not be applicable to all the Product References. Contact your Sales Office for approvals limitations

Ty-Met™ Stainless steel cable ties

Strap Type ties

Characteristics

The Strap Type ties have an easy self-locking mechanism and exist in pre-assembled lengths or on reel with separate heads

- Strong self-locking mechanism (pawl and ratchet), requires no time-consuming crimping or folding operations
- Head and body in corrosion resistant 316 grade stainless steel for high mechanical and chemical durability
- Uncoated, for high temperature applications
- Available in pre-assembled lengths up to 728 mm or in 2 reels of 152.4 metres per reel with separate heads (to be ordered separately), for a cost saving installation (no waste) around all sizes and shapes of objects
- Applications: installation of cables and pipes in extreme conditions and hazardous areas, such as: petrochemical and food processing industries, power stations, mining, shipbuilding, offshore and other aggressive environments

Technical Information

Material	316 grade stainless steel
Coating	Uncoated
Temperature range	-80°C to +300°C
Colour	Metallic
Flammability rating	Absolutely fireproof
Other properties	UV-resistant



Product Ref.	Length L [mm]	Width W [mm]	Max. Bundle ø [mm]	Min. tensile strength [N]	Quantity [pieces]	Tooling
PRE-ASSEMBLED STRAPS						
TYS8	271	7.9	50	890	50	CT1-TB
TYS14	372	7.9	101	890	50	CT2-TB CT3
TYS22	575	7.9	152	890	50	CT4-TB, CT5
TYS28	728	7.9	203	890	50	WT3S
STRAP ON REEL						
TYS1000	304.8 m (2 reels of 152.4m)	7.9	Variable	890		CT1-TB, CT2-TB CT3, CT4-TB CT5, WT3S
SEPARATE HEADS						
TYS5200H					50	

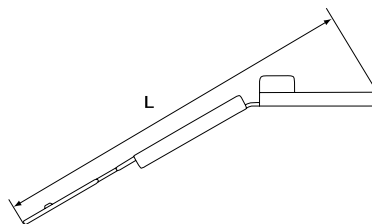
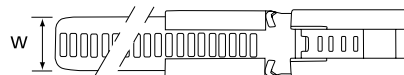

Ty-Met™ Stainless steel cable ties

Releasable Type

Characteristics

The Releasable Type stainless steel ties from ABB have a unique buckle design that allows the ties to be unfastened for re-use.

- Releasable and re-usable
- Corrosion resistant 316 grade stainless steel for high mechanical and chemical durability
- Fully coated version with non-toxic, Halogen free Polyester coating, for a superior protection of cables and installer's hands and for an improved insulation between dissimilar materials
- Fast, easy and reliable installation - can be installed by hand and if necessary, the slots at the end of the tie allow the use of a hook-type tool
- The additional ears can be bent back over the fastened tie to increase the tensile strength
- Applications: Installation of cables and pipes in extreme conditions and hazardous areas, indoor and outdoor, such as: petrochemical and food processing industries, power stations, mining, shipbuilding, offshore and other aggressive environments

Technical Information

Material	316 grade stainless steel
Coating	Polyester
Temperature range	-60°C to +165°C
Colour	Black
Flammability rating	Absolutely fireproof
Other properties	UV-resistant, Halogen free, non-toxic



Product Ref.	Length L [mm]	Width W [mm]	Material thickness [mm]	Bundle ø from... to [mm]	Min. tensile strength [N]	Quantity [pieces]	Tooling
YRL-5-150-BC	150	5.0	0.61	30-36	1300	100	CT1-TB CT2-TB CT4-TB
YRL-5-230-BC	230	5.0	0.61	30-60	1300	100	
YRL-5-330-BC	330	5.0	0.61	30-95	1300	100	
YRL-5-450-BC	450	5.0	0.61	30-130	1300	100	
YRL-5-650-BC	650	5.0	0.61	30-190	1300	100	
YRL-10-150-BC	150	10.0	0.61	40-40	2200	100	
YRL-10-230-BC	230	10.0	0.61	40-60	2200	100	
YRL-10-330-BC	330	10.0	0.61	40-95	2200	100	
YRL-10-450-BC	450	10.0	0.61	40-130	2200	100	
YRL-10-650-BC	650	10.0	0.61	40-190	2200	100	
YRL-10-750-BC	750	10.0	0.61	40-230	2200	100	
YRL-10-900-BC	900	10.0	0.61	40-275	2200	100	

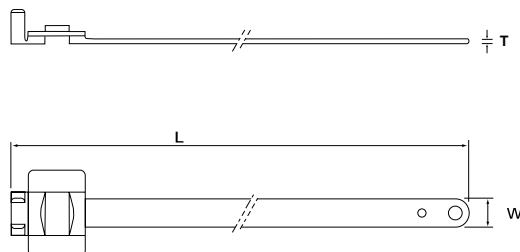

* Some approvals may not be applicable to all the Product References. Contact your Sales Office for approvals limitations

Ty-Met™ Stainless steel cable ties

Stainless steel ID system

Characteristics

A new durable identification system, ideally suitable for tough environments and extreme conditions, indoor and outdoor.

- Sleeves with pre-embossed characters (letters, digits and symbols)
- Pre-embossed characters are raised above the surface of the sleeve, which makes them easy to read even when covered with dust, paint or dirt
- Dedicated strips can carry 6, 10 or 16 sleeves
- Sleeves and strips are made of corrosion resistant 316 grade stainless steel (marine grade), for high mechanical and chemical durability
- The sleeves can be mounted onto the carrier strips (which will be secured by Ty-Met™ stainless steel ties) or directly onto Ty-Met™ stainless steel ties having a width up to 7.9 mm



Product Ref.	Description	L [mm]	W [mm]	H [mm]	T [mm]	Packaging [pieces]	Product Ref.	Description	L [mm]	W [mm]	H [mm]	T [mm]	Packaging [pieces]
SLEEVES WITH PRE-EMBOSSSED CHARACTERS, UNCOATED													
YID-CHAR-A	Letter "A"	9.2	8	2.5	0.25	100	YID-CHAR-U	Letter "U"	9.2	8	2.5	0.25	100
YID-CHAR-B	Letter "B"	9.2	8	2.5	0.25	100	YID-CHAR-V	Letter "V"	9.2	8	2.5	0.25	100
YID-CHAR-C	Letter "C"	9.2	8	2.5	0.25	100	YID-CHAR-W	Letter "W"	9.2	8	2.5	0.25	100
YID-CHAR-D	Letter "D"	9.2	8	2.5	0.25	100	YID-CHAR-X	Letter "X"	9.2	8	2.5	0.25	100
YID-CHAR-E	Letter "E"	9.2	8	2.5	0.25	100	YID-CHAR-Y	Letter "Y"	9.2	8	2.5	0.25	100
YID-CHAR-F	Letter "F"	9.2	8	2.5	0.25	100	YID-CHAR-Z	Letter "Z"	9.2	8	2.5	0.25	100
YID-CHAR-G	Letter "G"	9.2	8	2.5	0.25	100	YID-CHAR-1	Digit "1"	9.2	8	2.5	0.25	100
YID-CHAR-H	Letter "H"	9.2	8	2.5	0.25	100	YID-CHAR-2	Digit "2"	9.2	8	2.5	0.25	100
YID-CHAR-I	Letter "I"	9.2	8	2.5	0.25	100	YID-CHAR-3	Digit "3"	9.2	8	2.5	0.25	100
YID-CHAR-J	Letter "J"	9.2	8	2.5	0.25	100	YID-CHAR-4	Digit "4"	9.2	8	2.5	0.25	100
YID-CHAR-K	Letter "K"	9.2	8	2.5	0.25	100	YID-CHAR-5	Digit "5"	9.2	8	2.5	0.25	100
YID-CHAR-L	Letter "L"	9.2	8	2.5	0.25	100	YID-CHAR-6	Digit "6" or "9"	9.2	8	2.5	0.25	100
YID-CHAR-M	Letter "M"	9.2	8	2.5	0.25	100	YID-CHAR-7	Digit "7"	9.2	8	2.5	0.25	100
YID-CHAR-N	Letter "N"	9.2	8	2.5	0.25	100	YID-CHAR-8	Digit "8"	9.2	8	2.5	0.25	100
YID-CHAR-O	Letter "O"	9.2	8	2.5	0.25	100	YID-CHAR-BLANK	Blank filler	9.2	8	2.5	0.25	100
YID-CHAR-P	Letter "P"	9.2	8	2.5	0.25	100	YID-CHAR-PLUS	Symbol "+"	9.2	8	2.5	0.25	100
YID-CHAR-Q	Letter "Q"	9.2	8	2.5	0.25	100	YID-CHAR-MINUS	Symbol "-"	9.2	8	2.5	0.25	100
YID-CHAR-R	Letter "R"	9.2	8	2.5	0.25	100	YID-CHAR-SLASH	Symbol "/"	9.2	8	2.5	0.25	100
YID-CHAR-S	Letter "S"	9.2	8	2.5	0.25	100	YID-CHAR-EARTH	Symbol "⏚"	9.2	8	2.5	0.25	100
YID-CHAR-T	Letter "T"	9.2	8	2.5	0.25	100	YID-CHAR-SINE	Symbol "≈"	9.2	8	2.5	0.25	100

For digit 9 (nine) use digit 6 (six) upside down, for digit 0 (zero) use letter "O"

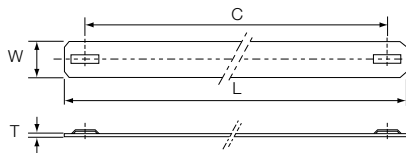

Product Ref.	Description	L [mm]	W [mm]	T [mm]	C [mm]	Packaging [pieces]
CARRIER STRIPS, UNCOATED						
YID-STRIP-6	Carrier strip for 6 sleeves	93	7.9	0.25	75	100
YID-STRIP-10	Carrier strip for 10 sleeves	133	7.9	0.25	115	100
YID-STRIP-16	Carrier strip for 16 sleeves	188	7.9	0.25	170	100

Strips can be secured with Ty-Met™ stainless steel ties having a width up to 7.9 mm

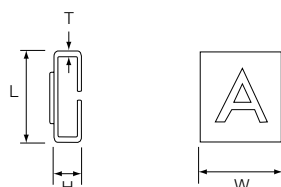

Ty-Met™ Stainless steel cable ties

Bands on reel with separate heads

Characteristics

A new range of stainless steel band on reel with separate heads, for a cost saving installation without waste

- Bands and heads are made of corrosion resistant 316 grade stainless steel, for high mechanical and chemical durability
- Bands are fully covered with a non-toxic, halogen free black Polypropylene sheath, for a superior protection of cables and installer's hands, and for an improved insulation between dissimilar materials
- Cost saving and flexible: the 25-metre reels allow a customised installation (no waste) around all sizes and shapes of objects
- Dedicated separate heads are easy to install
- Available in 5 widths up to 19.1 mm, to suit a wide range of applications

Technical Information

Material	316 grade non-magnetic stainless steel
Coating	Polypropylene
Temperature range	-25°C to +90°C
Colour	Bands & Heads: metallic Coating: black
Other properties	UV-resistant, Halogen free, non-toxic



Product Ref.	W1 [mm]	W2 [mm]	T1 [mm]	T2 [mm]	Length [m]	Tooling
BANDS ON REELS, FULLY COVERED WITH POLYPROPYLENE SHEATH						
YBR-6.4-25BC	6.4	7.2	0.48	1.25	25	CT8
YBR-9.5-25BC	9.5	10.3	0.48	1.25	25	
YBR-12.7-25BC	12.7	13.5	0.48	1.25	25	
YBR-15.9-25BC	15.9	16.7	0.48	1.25	25	
YBR-19.1-25BC	19.1	18.9	0.48	1.25	25	

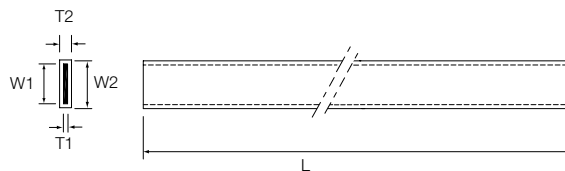

Product Ref.	Length L [mm]	Width W [mm]	Quantity [pieces]
SEPARATE HEADS, UNCOATED			
YBRH-6.4	9.3	15.9	100
YBRH-9.5	12.0	15.9	100
YBRH-12.7	16.5	22.3	100
YBRH-15.9	19.4	22.3	100
YBRH-19.1	21.7	22.3	100

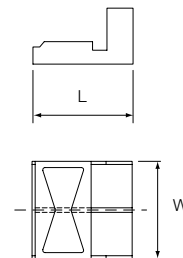

Ty-Met™ Stainless steel cable ties Mounting bases

Characteristics

- Mounting bases in corrosion resistant 316 grade stainless steel
- Uncoated, for high temperature applications (-80°C to +300°C)

Product Ref.	Length L [mm]	Width W [mm]	Dimension A [mm]	Mounting hole diameter [mm]	For stainless steel ties width up to [mm]	Quantity [pieces]
TCS25	57.1	25.4	31.8	6.7 (x2)	8.7	50

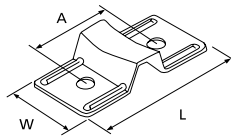

Ty-Met™ Stainless steel cable ties

Selection chart & Specifications

Type	Material	Coating	Series	Shape	Range		Packaging	Quantity
					Width [mm]	Length [mm]		
Ball-Lock Type	304 Grade Stainless Steel	Uncoated	YLS-4.6-...A		4.6	125 - 1400	Bag	100 ties per bag
			YLS-7.9-...A		7.9	125 - 1400	Bag	100 ties per bag
	316 Grade Stainless Steel	Uncoated	YLS-4.6-...B		4.6	125 - 1400	Bag	100 ties per bag
			YLS-7.9-...B		7.9	125 - 1400	Bag	100 ties per bag
		Polyester	YLS-4.6-...BC		4.6	125 - 1400	Bag	100 ties per bag
			YLS-7.9-...BC		7.9	125 - 1400	Bag	100 ties per bag
Ball-Lock Type, Heavy-Duty	316 Grade Stainless Steel	Uncoated	YLS-12-...B		12.0	200 - 1400	Bag	50 / 25 ties per bag
			YLS-16-...B		16.0	200 - 1400	Bag	50 / 25 ties per bag
		Polyester	YLS-12-...BC		12.0	200 - 1400	Bag	50 / 25 ties per bag
			YLS-16-...BC		16.0	200 - 1400	Bag	50 / 25 ties per bag
Ladder Type	316 Grade Stainless Steel	Uncoated	YLD-7-...B		7.0	150 - 610	Bag	100 ties per bag
			YLD-12-...B		12.0	150 - 610	Bag	100 ties per bag
		Polyester	YLD-7-...BC		7.0	150 - 610	Bag	100 ties per bag
			YLD-12-...BC		12.0	150 - 610	Bag	100 ties per bag
Strap Type	316 Grade Stainless steel	Uncoated	TYS8 to YYS28	Preassembled strap	7.9	271 - 728	Bag	50 ties per bag
			TYS1000	Strap	7.9	152.4 m	Reel (1)	304.8 m (2x152.4 m)
			TYS5200H	Heads	7.9		Bag	50 pieces per bag
Releasable Type	316 Grade Stainless Steel	Polyester	YRL-5-...BC		5.0	150 - 650	Bag	100 ties per bag
			YRL-10-...BC		10.0	150 - 900	Bag	100 ties per bag
Identification System	316 Grade Stainless Steel	Uncoated	YID-CHAR-...	Characters All letters & digits + 6 symbols			Bag	100 pieces per bag
			YID-STRIP-...	Strips		93 - 188	Bag	100 pieces per bag
Bands on Reel & Separate Heads	316 Grade Stainless Steel	Polypropylene	YBR-...-BC	Bands	6.4 - 9.5 - 12.7 - 15.9 - 19.1		Reel (1)	25 metres per reel
		Uncoated	YBRH-...	Heads	6.4 - 9.5 - 12.7 -		Bag	100 pieces per bag

Reel (1): Reel in cardboard box

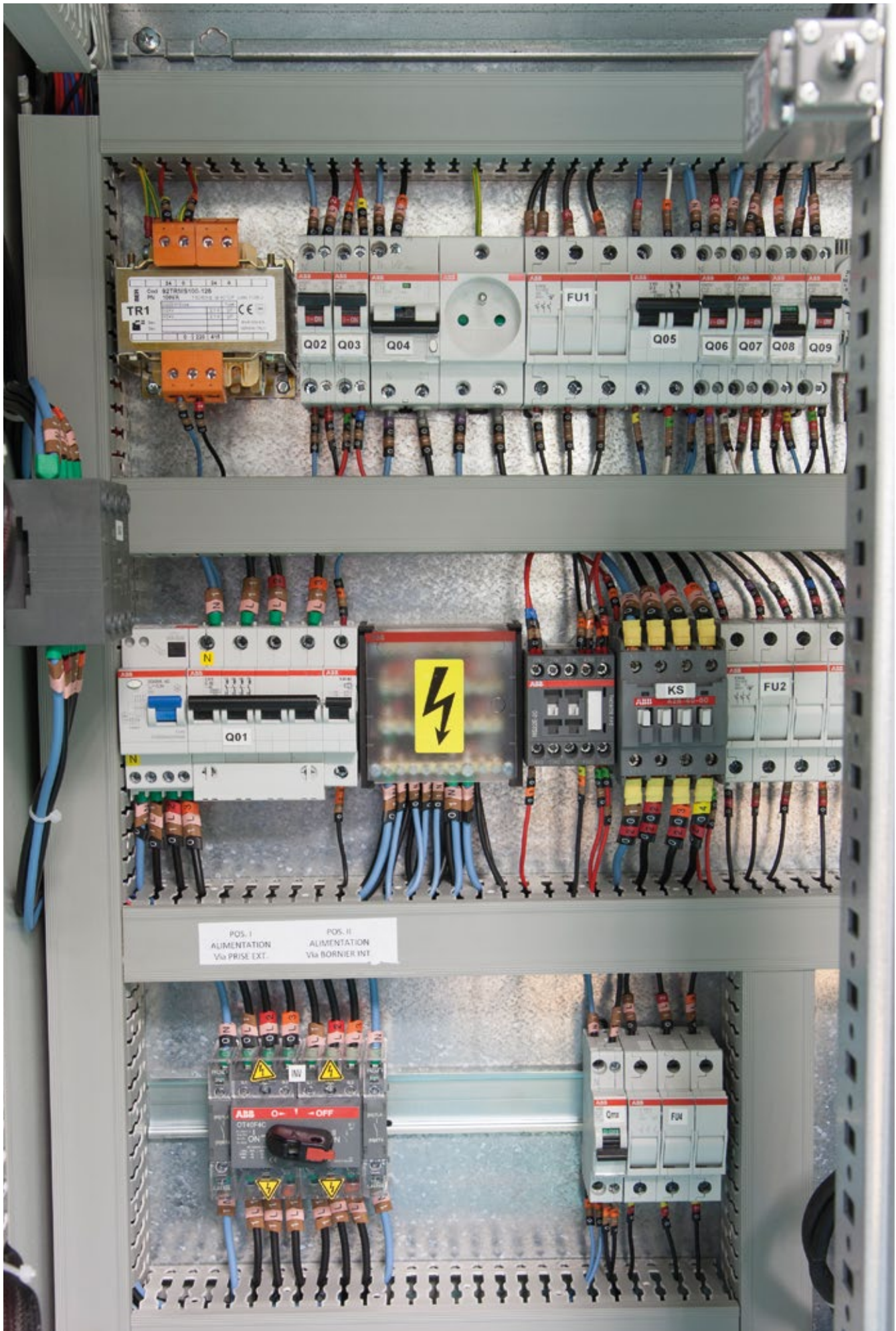

Table of Content

Mounting Bases, Cable Clamps & Other Fastening Accessories

Ty-Rap® High Performance Cable Ties	2
Ty-Fast® All-plastic cable ties	42
Ty-Met™ Stainless steel cable ties	66
Mounting bases and accessories	84
Overview	88
Mounting bases	89
Cable clamps	111
Accessories for flat cables	117
Cable protection systems	120
Cable tie tooling	130
Material specifications	144

Accessories Introduction



Ty-Rap® and Ty-Fast® Accessories

Accessories

To complement the range of premium cable ties, ABB has also developed an extensive range of mounting bases, cable clamps and other fastening accessories, to provide a professional solution to the most demanding applications in cable management.

A wide range of material is offered, from the classic Polyamide 6.6 to the high performance Fluoropolymer ETFE for applications in tough conditions.

To better suit each kind of applications, these products exist in a wide choice of shape & design, and with different mounting methods, from self-adhesive to glue and / or screw mounting.

In particular, with the new high performance mounting bases (TC345 series), ABB is now offering a mounting base that leads the industry with more features and better performance:

- new design & materials, for increased performance
- special adhesive formulation, specifically for Nylon Mounting bases

Typical applications include wiring in:

- control boxes & machine control devices
- office equipment & home appliances
- military & medical equipment
- lighting & electronic equipment

Mounting Bases & Accessories

Overview

Characteristics

Self-adhesive mounting bases and clamps for screw and rivet mounting



The main difference between a mounting base and a cable clamp is the way the cable bundle can be mounted: while the cable bundle is attached directly to the clamp, the mounting base requires a cable tie to hold the bundle.

ABB offers a wide range of mounting bases and cable clamps, which can be self-adhesive or for screw and rivet mounting.



- Standard material: Polyamide 6.6
- Available in different types / material to suit any application
- Available in a wide range of sizes
- Temperature range: -40°C to +85°C (+105°C for short periods)
- Low profile design
- Easy to install
- Extremely strong and durable adhesive
- When applicable ABB accessories are UL recognised
- Self-adhesive mounting bases allow wire and cable mounting where mounting holes can not be drilled
- Used for the adhesion on a variety of materials and for durable fixing of stamped signs and panels for the electrical industry

Typical surfaces

- Plastic
- Glass
- Wood
- Metal
- Paper
- Painted surfaces
- Ceramics

Mounting bases

2-way entry

Characteristics

- Can be used in 2-way entry style for cable ties having a width up to 7.6 mm
- For cable ties having a width up to 4.8 mm, the mounting bases can be used in 4-way entry style
- Choice of 3 materials: standard Polyamide 6.6 (natural), UV-resistant Polyamide 6.6 (black), Polyamide 6.6 flame retardant and ETFE Fluoropolymer (aquamarine)
- Supplied either on a rubber based (synthetic polymer) closed cell foam adhesive (installation: self-adhesive and/or screw) or without self-adhesive (installation: screw and/or 2-component glue*)

Technical Information TC347, TC347A, TC5347AR, TC347X and TC5347AX

Material	Polyamide 6.6
Temperature range	-40°C to +85°C (Self-adhesive version: 0°C to +65°C)
Flammability rating	UL 94 V-2
Colour	(see table)
Other properties	UV-resistant (black), Halogen free, Silicone free

Technical Information TC347FR (Flame retardant)

Material	Polyamide 6.6
Temperature range	-40°C to +85°C
Flammability rating	UL 94 V-0
Colour	Natural
Other properties	Halogen free, Silicone free

Technical Information TCZ347 (Fluoropolymer)

Material	ETFE Fluoropolymer
Temperature range	-46°C to +150°C
Flammability rating	UL 94 V-0
Colour	Aquamarine
Other properties	Silicone free, inert to most solvents and chemicals, hydrolytically stable, radiation resistant

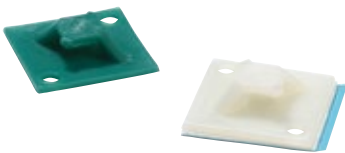

Product Ref.	Colour	Mounting method	Dimensions			For tie width up to [mm]	Mounting hole diameter [mm]	Quantity [pieces]
			L [mm]	W [mm]	H [mm]			
TC347	natural	screw / glue*	7.8	28.6	28.6	7.6	4.4 (2x)	1000
TC347X	UV-resistant black	screw / glue*	7.8	28.6	28.6	7.6	4.4 (2x)	1000
TC347FR	natural / flame retardant	screw / glue*	7.8	28.6	28.6	7.6	4.4 (2x)	1000
TCZ347	aquamarine	screw / glue*	7.8	28.6	28.6	7.6	4.4 (2x)	500
TC347A	natural	self-adhesive / screw	8.5	29.0	29.0	7.6	4.4 (2x)	1000
TC5347AR	natural	self-adhesive / screw	8.5	29.0	29.0	7.6	4.4 (2x)	100
TC5347AX	UV-resistant black	self-adhesive / screw	8.5	29.0	29.0	7.6	4.4 (2x)	100

* Glue = Product Ref. TC2PA (see page 147 for specifications)

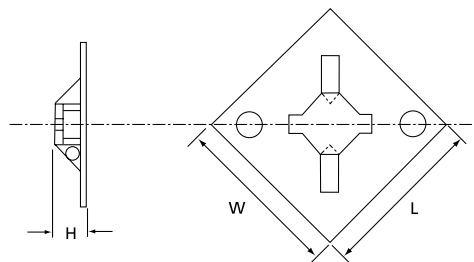

Mounting bases

4-way entry - high performance

Characteristics

- Design & materials, for increased performance
- Low profile shape (height: 5.1 mm), to save space and reduce the torque forces on the mounting base
- Ramped cable tie entries, for easier insertion of the cable tie
- Longer struts (up to the edges of the base), for better adhesion
- Special adhesive formulation (specifically for Nylon mounting bases) for high pull-off strength
- 2 kinds of self-adhesive material:
 - rubber-based, for immediate adhesion (15 minutes set-up time)
 - acrylic based, to have the possibility of repositioning the mounting base initially (set-up time: 24 to 72 hours)
- Two holes to have the possibility to use additional screws, for even stronger installations when required
- Supplied on two-up lining, for easy removal of the lining

Technical Information

Material - Moulding	Polyamide or UV-resistant Polyamide
Material - Self-adhesive	Rubber based or acrylic based (See table)
Temperature range	-60°C to +85°C (Self-adhesive version: 0°C to +70°C)
Flammability rating	UL 94 V-2
Colours	Natural or UV-resistant black (see table)
Other properties	UV-resistant black, Halogen free, Silicone free



Product Ref.	Colour	Mounting method	Dimensions			For tie width up to [mm]	Moun-ting hole diameter [mm]	Quantity [pieces]
			L [mm]	W [mm]	H [mm]			
TC345	natural	glue* / screws	28.6	28.6	5.1	5.2	4.0	1000
TC345A	natural	self-adhesive (rubber based) / screws	28.6	28.6	5.1	5.2	4.0	1000
TC5345A	natural	self-adhesive (rubber based) / screws	28.6	28.6	5.1	5.2	4.0	100
TC345AX	UV-resistant black	self-adhesive (rubber based) / screws	28.6	28.6	5.1	5.2	4.0	1000
TC5345AX	UV-resistant black	self-adhesive (rubber based) / screws	28.6	28.6	5.1	5.2	4.0	100

* Glue = Product Ref. TC2PA (see page 147 for specifications)

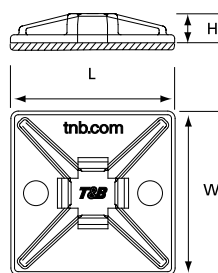

Mounting bases 4-way entry

Characteristics

- Supplied either on a rubber based (synthetic polymer) closed cell foam adhesive or without self adhesive (installation: screw and/or 2 component glue*)
- Available in standard Polyamide 6.6 (natural) or UV-resistant Polyamide 6.6 (black)

Technical Information

Material	Polyamide 6.6
Temperature range	Glue version: -40°C to +85°C Self-adhesive version: 0°C to +70°C
Flammability rating	UL 94 V-2
Colours	Natural or UV-resistant black (see table)
Other properties	UV-resistant black, Halogen free, Silicone free



Product Ref.	Colour	Mounting method	Dimensions			For tie width up to [mm]	Mounting hole diameter [mm]	Quantity [pieces]
			L [mm]	W [mm]	H [mm]			
FOR TIE WIDTH UP TO 3.0 MM								
TC050x050A	natural	self-adhesive	12.7	12.7	4.5	3.0	–	1000
TC050x050A-C	natural	self-adhesive	12.7	12.7	4.5	3.0	–	100
TC050x050AX	UV-resistant black	self-adhesive	12.7	12.7	4.5	3.0	–	1000
TC050x050AX-C	UV-resistant black	self-adhesive	12.7	12.7	4.5	3.0	–	100
FOR TIE WIDTH UP TO 3.6 MM								
TC344	natural	screw / glue*	19.1	19.1	4.9	3.6	3.0	1000
TC5344	natural	screw / glue*	19.1	19.1	4.9	3.6	3.0	100
TC344A	natural	self-adhesive / screw	19.1	19.1	4.9	3.6	3.0	1000
TC5344AR	natural	self-adhesive / screw	19.1	19.1	4.9	3.6	3.0	100
TC344AX	UV-resistant black	self-adhesive / screw	19.1	19.1	4.9	3.6	3.0	1000
TC5344AX	UV-resistant black	self-adhesive / screw	19.1	19.1	4.9	3.6	3.0	100

* Glue = Product Ref. TC2PA (see page 147 for specifications)

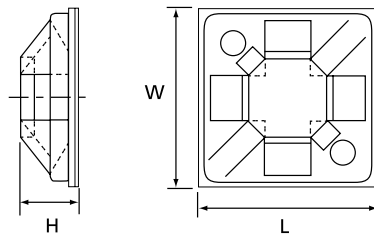

Mounting bases

4-way entry - for wide cable ties

Characteristics

- Supplied either on a rubber based (synthetic polymer) closed cell foam adhesive or without self adhesive (installation: screw and/or 2 component glue*)
- Available in standard Polyamide 6.6 (natural) or UV-resistant Polyamide 6.6 (black)

Technical Information

Material	Polyamide 6.6
Temperature range	Glue version: -60°C to +85°C Self-adhesive version: 0°C to +70°C
Flammability rating	UL 94 V-2
Colours	Natural or UV-resistant black (see table)
Other properties	UV-resistant black, Halogen free, Silicone free



Product Ref.	Colour	Mounting method	Dimensions			For tie width up to [mm]	Mounting hole diameter [mm]	Quantity [pieces]
			L [mm]	W [mm]	H [mm]			
FOR TIE WIDTH UP TO 7.9 MM (38.1 MM x 38.1 MM BASE)								
TC150x150	natural	screw / glue*	38.1	38.1	7.4	7.9	4.3	500
TC150x150L	natural	screw / glue*	38.1	38.1	7.4	7.9	4.3	50
TC150x150A	natural	self-adhesive / screw	38.1	38.1	7.4	7.9	4.3	500
TC150x150A-L	natural	self-adhesive / screw	38.1	38.1	7.4	7.9	4.3	50
TC150x150AX	UV-resistant black	self-adhesive / screw	38.1	38.1	7.4	7.9	4.3	500
TC150x150AX-L	UV-resistant black	self-adhesive / screw	38.1	38.1	7.4	7.9	4.3	50
FOR TIE WIDTH UP TO 7.9 MM (50.8 MM x 50.8 MM BASE)								
TC200x200	natural	screw / glue*	50.8	50.8	7.4	7.9	4.3	500
TC200x200L	natural	screw / glue*	50.8	50.8	7.4	7.9	4.3	50
TC200x200A	natural	self-adhesive / screw	50.8	50.8	7.4	7.9	4.3	500
TC200x200A-L	natural	self-adhesive / screw	50.8	50.8	7.4	7.9	4.3	50
TC200x200AX	UV-resistant black	self-adhesive / screw	50.8	50.8	7.4	7.9	4.3	500
FOR TIE WIDTH UP TO 19.1 MM (50.8 MM x 50.8 MM BASE)								
TC368**	natural	screw / glue*	50.8	50.8	6.6	19.1	4.3	500
TC368A**	natural	self-adhesive / screw	50.8	50.8	6.6	19.1	4.3	500

* Glue = Product Ref. TC2PA (see page 147 for specifications)

** Not UL Listed

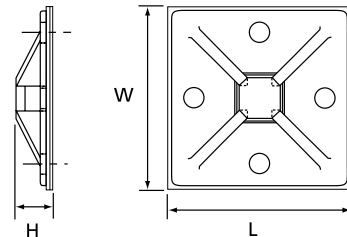

Mounting bases

Low profile plates

Characteristics

- Low profile
- Easy to use
- Self-adhesive or to be glued with 2-component glue*

Technical Information

Material Polyamide 6.6
 Temperature range -40°C to +85°C (Self-adhesive version: 0°C to +65°C)
 Colour Natural or UV-resistant black (see table)
 Flammability rating UL 94 V-2
 Other properties Halogen free, Silicone free, UV-resistant black



Product Ref.	Colour	Mounting method	Dimensions							For tie width up to [mm]	Weight [g/100]	Quantity [pieces]
			H [mm]	T [mm]	W [mm]	L [mm]	E [mm]	F [mm]				
TC817-TB	natural	glue*	4.8	–	11.0	11.0	–	–	4.8	51	1000	
TC342	natural	glue*	5.7	–	29.0	29.0	7.5	21.0	4.8	340	1000	
TC342X	UV-resistant black	glue*	5.7	–	29.0	29.0	7.5	21.0	4.8	340	1000	
TC342A	natural	self-adhesive	5.7	0.8	29.0	29.0	7.5	21.0	4.8	360	1000	
TC5342A	natural	self-adhesive	5.7	0.8	29.0	29.0	7.5	21.0	4.8	360	100	
TC342A-X	UV-resistant black	self-adhesive	5.7	0.8	29.0	29.0	7.5	21.0	4.8	360	1000	

* Glue = Product Ref. TC2PA (see page 147 for specifications)

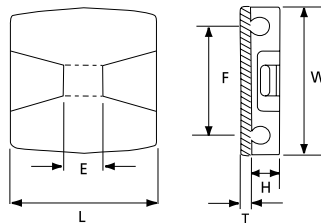

Mounting bases

Self-adhesive mounting cradle

Characteristics

- Accepts cable ties to 7.6 mm width
- Supplied "two-up" on closed cell foam with synthetic polymer "rubber" based adhesive
- Use M3.5 self-tapping screw for added strength if desired

Technical Information

Material	Polyamide 6.6
Temperature range	0°C to +65°C
Colour	Natural or UV-resistant black (see table)
Mounting method	Self adhesive and/or screw
Flammability rating	UL 94 V-2
Other properties	UV-resistant black, Halogen free, Silicone free



Product Ref.	Colour	Dimensions				For tie with up to [mm]	Quantity [pieces]
		H [mm]	T [mm]	L [mm]	W [mm]		
MCNY-1250-9-L	natural	7.2	0.8	31.7	25.4	7.6	50
MCNY-1250-9-C	natural	7.2	0.8	31.7	25.4	7.6	100
MCNY-1250-9-D	natural	7.2	0.8	31.7	25.4	7.6	500
MCNY-1250-0-C	UV-resistant black	7.2	0.8	31.7	25.4	7.6	100

For other colours and quantities please contact your Sales Office

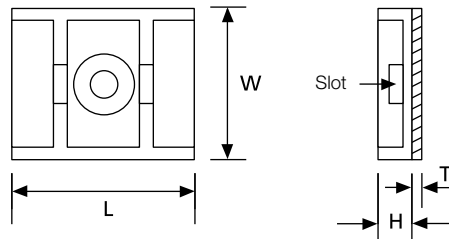

Mounting bases

Saddle support

Characteristics

- Tie mounting bases with supporting saddle
- For screw- or rivet-mounting
- The prism-shape of the saddle prevents twisting around the fixture
- High strength through compact design
- Non-conductive, non-corrosive, resistant to fuels, lubricants and most chemicals
- Available in natural nylon, UV-resistant nylon or heat stabilised black version

Technical Information

Material	Polyamide 6.6 or heat stabilised Polyamide 6.6
Temperature range	-40°C to +85°C
Colour	Natural or UV-resistant black (see table)
Mounting method	Screw
Flammability rating	UL 94 V-2
Other properties	Halogen free, Silicone free, UV-resistant black



Product Ref.	Colour	Dimensions				For tie width up to [mm]	Mounting hole diameter [mm]	Quantity [pieces]
		H [mm]	W [mm]	L [mm]	D [mm]			
TC140	natural	6.7	8.7	14.2	1.8	2.4	3.0	500
TC5140	natural	6.7	8.7	14.2	1.8	2.4	3.0	100
TC141	natural	7.5	11.1	17.0	2.3	4.8	3.8	500
TC5141	natural	7.5	11.1	17.0	2.3	4.8	3.8	100
TC142	natural	10.7	14.2	23.4	2.9	7.6	5.2	500
TC5142	natural	10.7	14.2	23.4	2.9	7.6	5.2	100
TC142X*	UV-resistant black / heat stabilised	10.7	14.2	23.4	2.9	7.6	5.2	500
TC5142X*	UV-resistant black / heat stabilised	10.7	14.2	23.4	2.9	7.6	5.2	100

* Are not UL recognised

For other colours and quantities please contact your Sales Office

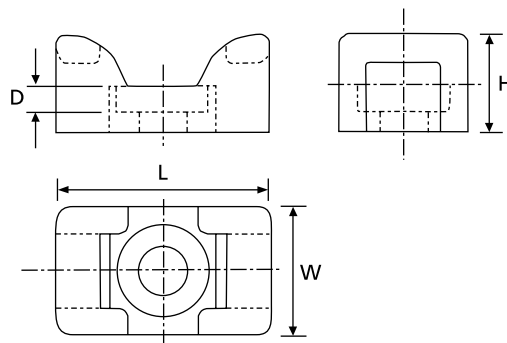

Mounting bases

Saddle support

Characteristics

- Tie mounting bases with supporting saddle
- For screw- or rivet-mounting
- The prism-shape of the saddle prevents twisting around the fixture
- High strength through compact design
- Non-conductive, non-corrosive, resistant to fuels, lubricants and most chemicals
- Available in UV-resistant, heat stabilised black version

Technical Information

Material	Polyamide 6.6 or heat stabilised Polyamide 6.6
Temperature range	-40°C to +85°C (Natural) -40°C to +105°C (UV-resistant black)
Colour	Natural or UV-resistant black
Mounting method	Screw or rivet
Flammability rating	UL 94 V-2
Other properties	Halogen free, Silicone free, UV-resistant black



Product Ref.	Colour	Dimensions				For tie width up to [mm]	Mounting hole diameter [mm]	Quantity [pieces]
		H [mm]	W [mm]	L [mm]	D [mm]			
SMNY-001-9-D	natural	7.1	9.8	15.2	4.7	4.8	4.2	500
SMNY-001-0-D	UV-resistant black / heat stabilised	7.1	9.8	15.2	4.7	4.8	4.2	500

For other colours and quantities please contact your Sales Office

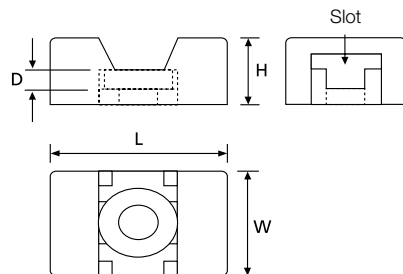

Mounting bases

Saddle-type mounting base

Characteristics

The saddle-type mounting bases allow 3 possible cable mounting:

- the cables can be attached to a flat surface on which the base is screwed
- the cable bundles can be mounted in parallel
- the cable bundles can be mounted crosswise

Can also be used for the mounting of cylindrical objects having a diameter between 12.7 and 31.8 mm

Technical Information

Material	Polyamide 6.6
Temperature range	-40°C to +85°C
Colour	Natural
Mounting method	Screw
Flammability rating	UL 94 V-2
Other properties	Halogen free, Silicone free



Product Ref.	Dimensions				For tie width up to [mm]	Mounting hole diameter [mm]	Weight [g/100]	Quantity [pieces]
	H [mm]	W [mm]	L [mm]	D [mm]				
TC92	14.3	15.1	15.1	12.7 - 31.8	4.8	3.9	143	100

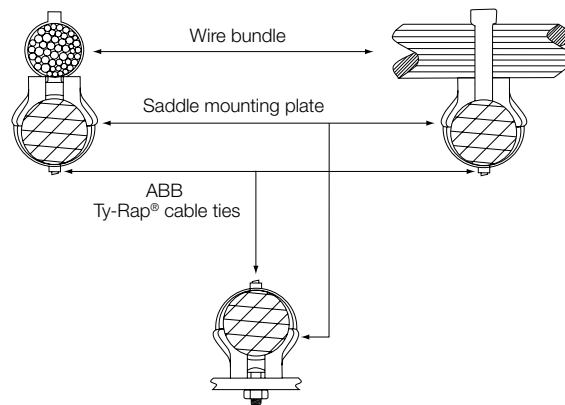
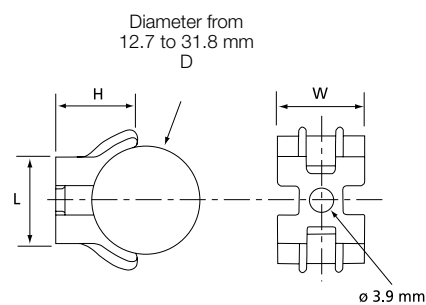

Mounting bases

Screw-mounted miniature bases

Characteristics

- Low profile mounting base
- For screw- or rivet-mounting
- Easy to use thanks to the cable tie insertion guide

Technical Information

Material	Polyamide 6.6
Temperature range	-40°C to +85°C
Colour	Natural
Mounting method	Fillister-head screw
Flammability rating	UL 94 V-2
Other properties	Halogen free, Silicone free



Product Ref.	Dimensions				For tie width up to [mm]	Mounting hole diameter [pieces]	Weight [g/100]	Quantity [pieces]
	H [mm]	W [mm]	L [mm]	D [mm]				
TC814-TB	4.8	9.5	19.1	2.0	4.8	3.3	44	1000
TC112-TB	4.8	9.5	19.1	2.0	4.8	4.4	44	1000
TC812-TB	4.8	9.5	19.1	2.0	4.8	5.1	44	1000

For other colours and quantities please contact your Sales Office

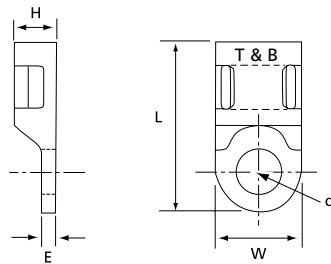

Mounting bases

Screw-mounted miniature bases

Characteristics

- Extremely low profile
- For screw- or rivet-mounting
- Easy to use thanks to the cable tie insertion guide

Technical Information

Material	Polyamide 6.6
Temperature range	-40°C to +85°C
Colour	Natural
Mounting method	Screw or rivet
Flammability rating	UL 94 V-2
Other properties	Halogen free, Silicone free



Product Ref.	Dimensions			For tie width up to [mm]	Mounting hole		Weight [g/100]	Quantity [pieces]
	H [mm]	W [mm]	L [mm]		diameter D1 [mm]	diameter D2 [mm]		
TC804-TB*	2.4	7.9	10.2	2.4	2.3	4.7	11	1000
TC104	2.4	7.9	10.3	2.4	3.4	6.5	11	1000
TC102	3.2	12.7	19.1	4.8	4.4	8.7	50	1000
TC502	3.2	12.7	19.1	4.8	4.4	8.7	50	100

* UL Recognized

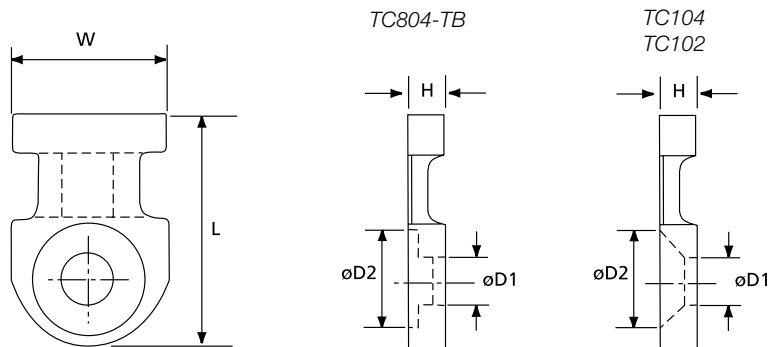

Mounting bases

Screw-mounted - for wide cable ties

Characteristics

- Extremely low profile
- For screw- or rivet-mounting
- Easy to use thanks to the cable tie insertion guide
- Secure fixing with 2 fastening holes

Technical Information

Material	Polyamide 6.6
Temperature range	-40°C to +85°C
Colour	Natural
Mounting method	2 screws
Flammability rating	UL 94 V-2
Other properties	Halogen free, Silicone free



Product Ref.	Dimensions					For tie width up to [mm]	Mounting hole diameter [mm]	Weight [g/100]	Quantity [pieces]
	H [mm]	W [mm]	L [mm]	D [mm]	E [mm]				
TC815-TB	6.4	19.1	31.2	19.9	6.4	7.6	5.3	278	500

For other colours and quantities please contact your Sales Office

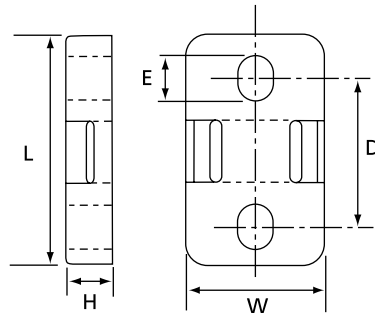

Mounting bases

Screw-mounted - for crosswise fastening

Characteristics

- Extremely low profile
- For screw- or rivet-mounting
- Easy to use thanks to the cable tie insertion guide
- Two ties can be fastened crosswise to securely fix cable intersections

Technical Information

Material	Polyamide 6.6
Temperature range	-40°C to +85°C
Colour	Natural
Mounting method	Screw or rivet
Flammability rating	UL 94 V-2
Other properties	Halogen free, Silicone free



Product Ref.	Dimensions					For tie width up to [mm]	Mounting hole diameter [mm]	Weight [g/100]	Quantity [pieces]
	H [mm]	W [mm]	L [mm]	D [mm]	E [mm]				
TC828-TB	3.8	10.1	22.5	1.5	13.4	4.8	4.3	46	1000
TC5828	3.8	10.1	22.5	1.5	13.4	4.8	4.3	46	100

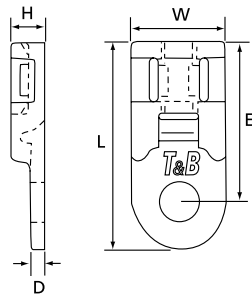

Mounting bases

Screw-mounted - for crosswise fastening

2-way and 4-way entry mounting bases



Product ref.	Mounting method	Width H [mm]	Length D [mm]	For tie width up to [mm]	Mounting hole (2x) diameter [mm]	Quantity [pieces]
TC5344A-NDT	self-adhesive*/screw	19.1	19.1	3.6	3	100
TC5344A-PDT	self-adhesive*/screw	19.1	19.1	3.6	3	100
TC344A-NDT	self-adhesive*/screw	19.1	19.1	3.6	3	1000
TC5347A-NDT	self-adhesive*/screw	29	29	7.6	4.4	100
TC5347A-PDT	self-adhesive*/screw	29	29	7.6	4.4	100
TC347A-NDT	self-adhesive*/screw	29	29	7.6	4.4	1000



Saddle support

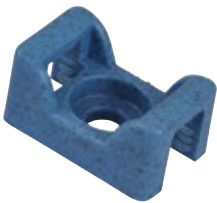

Product ref.	Mounting method	Width H [mm]	Length D [mm]	For tie width up to [mm]	Mounting hole diameter [mm]	Quantity [pieces]
TC5141-NDT	screw	11.1	17	4.8	3.8	100
TC5141-PDT	screw	11.1	17	4.8	3.8	100
TC141-NDT	screw	11.1	17	4.8	3.8	500
TC5142-NDT	screw	14.2	23.4	7.6	5.2	100
TC5142-PDT	screw	14.2	23.4	7.6	5.2	100
TC142-NDT	screw	14.2	23.4	7.6	5.2	500



Screw-mounted miniature bases



Product ref.	Mounting method	Width H [mm]	Length D [mm]	For tie width up to [mm]	Mounting hole diameter D1 [mm]	Mounting hole diameter D2 [mm]	Quantity [pieces]
TC5102-NDT	screw	12,7	19,1	4,8	4,4	8,7	100
TC102-NDT	screw	12,7	19,1	4,8	4,4	8,7	1000
TC102-PDT	screw	12,7	19,1	4,8	4,4	8,7	1000



Low profile plates

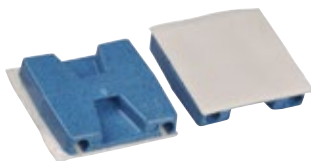

Product ref.	Mounting method	Width H [mm]	Length D [mm]	For tie width up to [mm]	Quantity [pieces]
TC5342A-NDT	self-adhesive*	29	29	4,8	100
TC5342A-PDT	self-adhesive*	29	29	4,8	100
TC342A-NDT	self-adhesive*	29	29	4,8	1000



* Surface preparation: surface should be cleaned with alcohol-based cleaner before application.
 Installation: Surface must be clean and dry prior to application of accessory.
 Allow 15-minute setting time for maximum adhesion performance of synthetic rubber adhesive (SRA).

Mounting bases

Screw-mounted - for crosswise fastening

Characteristics

- Extremely low profile
- For screw- or rivet-mounting
- Easy to use thanks to the cable tie insertion guide
- Two ties can be fastened crosswise to securely fix cable intersections

Technical Information

Material	Polyamide 6.6
Temperature range	-40°C to +85°C
Colour	Natural
Mounting method	Screw or rivet
Flammability rating	UL 94 V-2
Other properties	Halogen free, Silicone free



Product Ref.	Dimensions					For tie width up to [mm]	Mounting hole diameter [mm]	Weight [g/100]	Quantity [pieces]
	H [mm]	W [mm]	L [mm]	D [mm]	E [mm]				
TC826-TB	5.7	12.7	23.8	5.3	2.0	4.8	4.4	102	1000

For other colours and quantities please contact your Sales Office

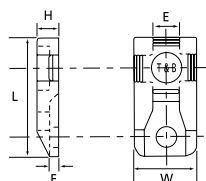

Mounting bases

Screw-mounted supporting bases

Characteristics

- Supporting mounting base with strong hold thanks to 2 mounting holes
- Can be screwed or riveted
- Allows double and/or crosswise (two ties) fixing
- For parallel and through mounting with support
- Suitable for large bundle diameters

Technical Information

Material	Polyamide 6.6
Temperature range	-40°C to +85°C
Colour	Natural
Mounting method	2 screws or 2 rivets
Flammability rating	UL 94 V-2
Other properties	Halogen free, Silicone free



Product Ref.	Dimensions						For tie width up to [mm]	Mounting hole diameter [mm]	Weight [g/100]	Quantity [pieces]
	H [mm]	W [mm]	L [mm]	G [mm]	E [mm]	F [mm]				
TC106	25.4	19.1	25.4	12.7	4.6	16.5	7.6	3.3 (x 2)	435	200
TC109	11.1	9.9	14.3	7.1	1.7	7.0	4.8	2.4 (x 2)	45	1000

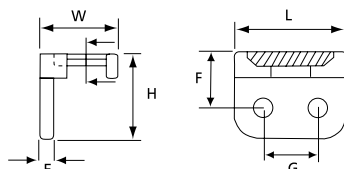
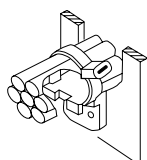

Mounting bases

Screw-mounted strips for multiple bundling

Characteristics

- Tie mounting strips for up to 6 bundles simultaneously
- When mounted, the tie is guided through the clamp for fast assembly

Product Ref. TC1101 to TC1117

- Simple and strong flat mounting beams for fixing multiple cables, bundles or components
- Mil. Specified (MS-3339-...-...)
- VG approved (VG 95387, item 2)

Product Ref. TC375 and TC376

- For vertical and double-side mounting

Product Ref. TC101 and TC103

- Elongated fastening hole on one end allows greater flexibility during mounting

Technical Information

Material	Polyamide 6.6
Temperature range	-40°C to +85°C
Colour	Natural
Mounting method	2 screws (1 screw for Prod. Ref. TC376 & TC375)
Flammability rating	UL 94 V-2
Other properties	Halogen free, Silicone free



Product Ref.	Mil. Spec.	Dimensions					Max. number of bundles	For tie width up to	Mounting hole diameter	Weight	Quantity
		H	W	L	D	E					
		[mm]	[mm]	[mm]	[mm]	[mm]	[mm]	[mm]	[mm]	[g/100]	[pieces]
TC101	-	3.2	12.7	50.0	35.6	9.5	1	4.8	5.2	151	1000
TC103	-	5.1	15.8	79.0	59.6	18.6	1	7.6	6.9	505	500
TC1101	MS-3339-1-9	3.2	12.7	44.0	31.8	9.5	1	4.8	3.7	160	100
TC1102	MS-3339-2-9	3.2	12.7	76.0	31.8	9.5	2	4.8	3.7	280	100
TC1103	MS-3339-3-9	3.2	12.7	108.0	31.8	9.5	3	4.8	3.7	400	100
TC1104	MS-3339-4-9	3.2	12.7	140.0	31.8	9.5	4	4.8	3.7	520	100
TC1105	MS-3339-5-9	3.2	12.7	171.0	31.8	9.5	5	4.8	3.7	650	100
TC1112	MS-3339-11-9	5.2	15.9	244.0	38.1	14.3	6	7.6	3.7	1679	100
TC1113	MS-3339-6-9	5.2	15.9	53.3	38.1	14.3	1	7.6	3.7	385	100
TC1114	MS-3339-7-9	5.2	15.9	91.4	38.1	14.3	2	7.6	3.7	658	100
TC1115	MS-3339-8-9	5.2	15.9	130.0	38.1	14.3	3	7.6	3.7	914	100
TC1116	MS-3339-9-9	5.2	15.9	168.0	38.1	14.3	4	7.6	3.7	1190	100
TC1117	MS-3339-10-9	5.2	15.9	206.0	38.1	14.3	5	7.6	3.7	1141	100
TC375	-	19.1	17.5	93.0	-	6.4	5	4.8	4.8	486	100
TC376	-	17.0	17.5	44.0	-	6.4	2	4.8	4.8	253	100

TC375 & TC376

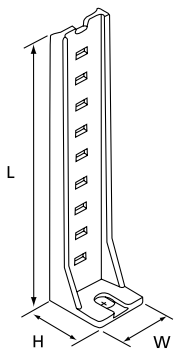

For other colours and quantities please contact your Sales Office

TC1101 ... TC1117

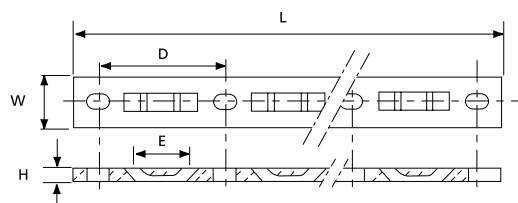

TC101 & TC103

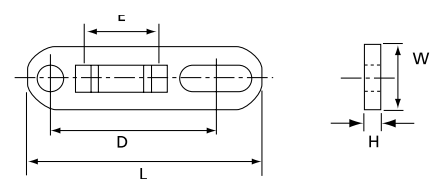

Mounting bases

Weather resistant - Heavy-duty

Characteristics

- Tie mounting base for outdoor installation
- A strong, weatherproof and durable outdoor fastening solution for pipes, hoses, cables, etc.

Product Ref. TC5358 and TC5359

- Built-in plug for mounting into walls
- Easy to install: the plug is simply hammered into a hole
- The lamellar plug ensures high tensile strength and durability

Product Ref. TC5355 to TC5357

- For screw-fastening
- Ergonomically shaped for trouble-free installation

Technical Information

Material	UV-stabilised Polyamide 6.6
Temperature range	-40°C to +85°C
Colour	Black
Mounting method	Screw (for Product ref. TC5355 to TC5357 only)
Flammability rating	UL 94 V-2
Other properties	UV-resistant, Halogen free, Silicone free



Product Ref.	Dimensions						For tie width up to [mm]	Mounting hole diameter [mm]	Weight [g/100]	Quantity [pieces]
	H [mm]	W [mm]	L [mm]	E [mm]	F [mm]	f [mm]				
MOUNTING CRADLE										
TC5355	15.9	19.1	44.5	11.1	28.6	-	12.7	4.6	500	25
TC5356	15.9	19.1	44.5	11.1	28.6	-	12.7	5.2	500	25
TC5357	15.9	19.1	44.5	11.1	28.6	-	12.7	6.7	500	25
WALL PLUG										
TC5358	31.8	9.9	9.9	7.1	5.6	2.3	4.8	6.4 (in wall)	120	100
TC5359	38.4	19.1	19.1	8.1	14.0	3.1	12.7	9.5 (in wall)	320	50

TC5355-TC5356-TC5357

TC5358-TC5359

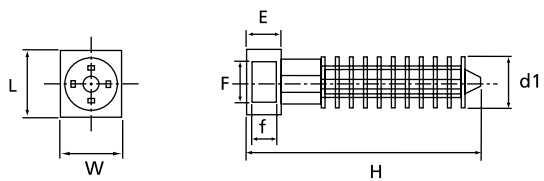
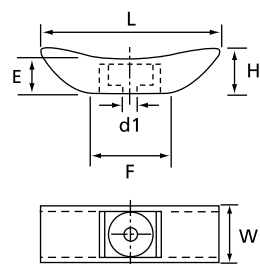

Mounting bases

Clip-in mounting bases for blind mounting

Characteristics

- Clip-in tie mounting bases for housings, faceplates etc
- With fastening clip for blind-mounting and two openings for 2.8 mm or 4.8 mm ties
- Low profile

Technical Information

Material	Polyamide 6.6
Temperature range	-40°C to +85°C
Colour	Natural
Mounting method	Clip in
Flammability rating	UL 94 V-2
Other properties	Halogen free, Silicone free



Product Ref.	Dimensions					Panel thickness from ... to	For tie width up to	Mounting hole diameter	Weight [g/100]	Quantity [pieces]
	H	W	G	E	F					
	[mm]	[mm]	[mm]	[mm]	[mm]	[mm]	[mm]	[mm]	[g/100]	[pieces]
TC121-TB	10.4	11.2	3.4	2.0	6.1	0.1 - 3.2	2.4 or 4.8	6.3	31	1000

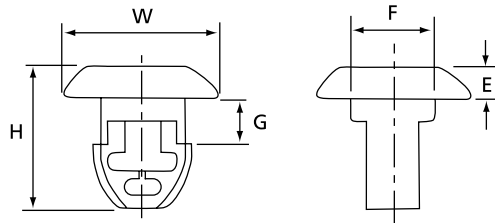

E49405

Mounting bases

Clip-in mounting bases for surface mounting

Characteristics

- Clip-in tie mounting bases for housings, faceplates etc
- With fastening clip for surface mounting
- Low profile

Technical Information

Material	Polyamide 6.6
Temperature range	-40°C to +85°C
Colour	Natural (TC823-TB & TC5823) UV-resistant black (TC823X)
Mounting method	Clip in
Flammability rating	UL 94 V-2
Other properties	UV-resistant (black), Halogen free, Silicone free



Product	Dimensions						Panel thickness from ... to	For tie width up to	Mounting hole diameter	Weight	Quantity
	H	W	L	G	E	F					
Ref.	[mm]	[mm]	[mm]	[mm]	[mm]	[mm]	[mm]	[mm]	[mm]	[g/100]	[pieces]
TC823-TB	16.8	11.1	11.1	3.6	5.1	5.8	0.1 - 3.2	4.8	6.2 - 6.5	68	1000
TC5823	16.8	11.1	11.1	3.6	5.1	5.8	0.1 - 3.2	4.8	6.2 - 6.5	68	100
TC823X*	16.8	11.1	11.1	3.6	5.1	5.8	0.1 - 3.2	4.8	6.2 - 6.5	68	1000

* Are not UL recognised

For other colours and quantities please contact your Sales Office

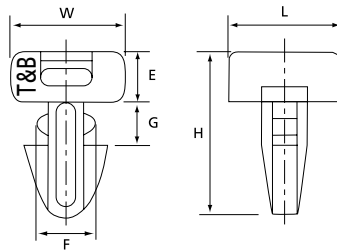

Mounting bases

Rivet-mounted bases

Characteristics

- Low profile mounting base with integrated rivet
- Easy to install into normal or blind holes: just hammer in the expanding harbour
- Parts are colour-coded according to hole diameter to avoid confusion

Technical Information

Material	Polyamide 6.6
Temperature range	-40°C to +85°C
Colour	See table
Mounting method	Rivet mounted
Flammability rating	UL 94 V-2
Other properties	Halogen free, Silicone free



Product Ref.	Colour	Dimensions							For tie width up to [mm]	Mounting hole diameter [mm]	Weight [g/100]	Quantity [pieces]
		W [mm]	L [mm]	F [mm]	E [mm]	G [mm]	H [mm]	J [mm]				
TC116-TB	red	12.7	19.1	3.2	13.9	8.6	15	3.9	4.8	3.7	70.5	1000
TC118-TB	blue	12.7	19.1	3.2	13.9	8.6	15	4.5	4.8	4.4	71.0	1000
TC120	yellow	12.7	19.1	3.2	13.9	8.6	15	5.2	4.8	4.9	71.5	1000

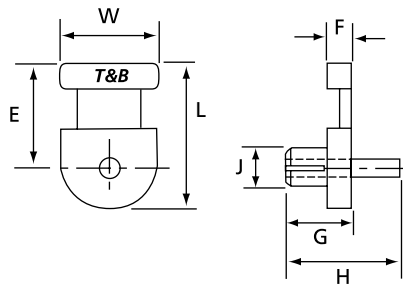

E49405

Mounting bases Aluminium plates

Characteristics

- Very strong mounting base for gluing or screw mounting or self-adhesive mounting
- Low profile
- Soft material can be perfectly shaped onto any support
- Lightweight
- Does not age under extreme temperatures

Technical Information

Material	Aluminium (3003, ASTM-B-209)
Temperature range	-100°C to +450°C (Self-adhesive version: 0°C to +65°C)
Colour	Metallic
Mounting method	Glue (*) and / or screw or self-adhesive
Flammability rating	Fire proof
Other properties	UV-resistant

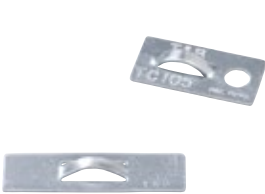

Product Ref.	Mounting method	Dimensions					For tie width up to [mm]	Mounting hole diameter [mm]	Weight [g/100]	Quantity [pieces]
		H [mm]	W [mm]	L [mm]	E [mm]	F [mm]				
TC105AP	self-adhesive / screw	3.8	13.2	25.4	4.8	0.8	4.8	4.9	67	1000
TC105	screw	3.8	13.2	25.4	4.8	0.8	4.8	4.9	67	1000
TC5105	screw	3.8	13.2	25.4	4.8	0.8	4.8	4.9	67	100
TC824-TB	2-component glue*	3.8	9.5	34.9	-	0.8	4.8	-	69	1000

* Glue = Product Ref TC2PA (see page 147 for specifications)

TC824-TB

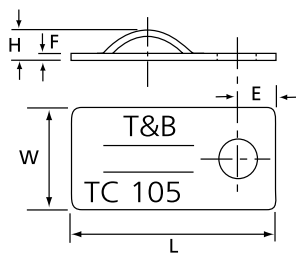

TC105 and TC105AP

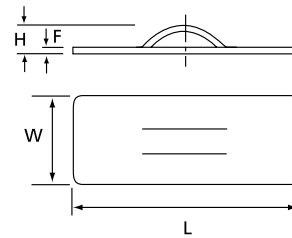

Cable clamps

Plain Edge Cable clamps

Characteristics

- 18 diameters and 2 widths with mounting holes for M4 and M5 screws
- Indoor application

Technical Information

Material	Polyamide 6.6
Temperature range	-40°C to +85°C
Colour	Black
Mounting method	Screw
Flammability rating	UL 94 V-2
Other properties	Halogen free, Silicone free



Product Ref.	Dimensions						Quantity [pieces]
	D1 closed diameter [mm]	E [mm]	T [mm]	W [mm]	Z [mm]	X [mm]	
N4NY-002-0-M	3.20	8.71	1.27	9.53	5.54	4.30	1000
N4NY-003-0-M	4.70	9.60	1.27	9.53	5.54	4.30	1000
N4NY-004-0-M	6.30	10.70	1.27	9.53	5.54	4.30	1000
N4NY-005-0-M	7.90	11.20	1.27	9.53	5.54	4.30	1000
N4NY-006-0-M	9.50	11.79	1.27	9.53	5.54	4.30	1000
N4NY-008-0-M	12.70	13.46	1.27	9.53	5.54	4.30	1000
N6NY-004C-0-M	6.35	11.10	1.52	12.71	5.54	5.16	1000
N6NY-005C-0-M	7.92	12.24	1.52	12.71	5.54	5.16	1000
N6NY-006C-0-M	9.53	12.70	1.52	12.71	5.54	5.16	1000
N6NY-008C-0-M	12.70	14.05	1.52	12.71	5.54	5.16	1000
N6NY-009-0-M	14.27	15.32	1.52	12.71	5.54	5.16	1000
N6NY-010-0-M	15.88	15.88	1.52	12.71	5.54	5.16	1000
N6NY-011-0-M	17.48	16.89	1.52	12.71	5.54	5.16	1000
N6NY-012-0-M	19.05	17.75	1.52	12.71	5.54	5.16	1000
N6NY-013-0-M	20.62	19.43	1.52	12.71	5.54	5.16	1000
N6NY-014-0-M	22.23	20.19	1.52	12.71	5.54	5.16	1000
N6NY-016-0-M	25.40	21.00	1.52	12.71	5.54	5.16	1000

Also available in quantities of 100 pieces. For other colours please contact your Sales Office

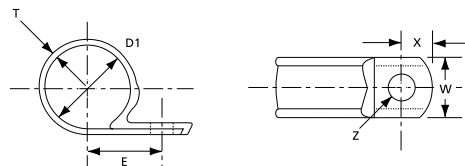

Cable clamps

Adjustable, ladder style clamps

Characteristics

- Ladder style fastener is easily released and refastened
- Supplied "single-cut" on a rubber based closed cell foam adhesive
- In addition, can also be mounted with a screw, for improved pull-off strength

Technical Information

Material	Polyamide 6.6
Temperature range	0°C to +65°C
Colour	Grey
Mounting method	Self adhesive and / or screw-mounting
Flammability rating	UL 94 V-2 (clamp)
Other properties	Halogen free, Silicone free

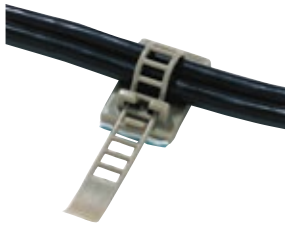

Product Ref.	Dimensions				Bundle diameter range [mm]	Screw hole diameter [mm]	Quantity [pieces]
	H [mm]	W [mm]	L [mm]	S [mm]			
ULNY-013-8-C	59.5	18	25	8	3 - 12.7	2.79	100
ULNY-018-8-C	79.4	21	30	12	5 - 21.0	2.79	100
ULNY-023-8-C	85.5	25	35	14	7 - 25.0	3.43	100

For other quantities please contact your Sales Office

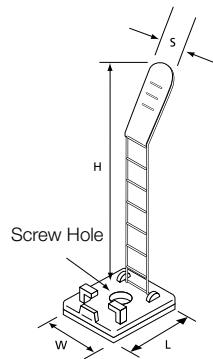

Cable clamps

Latching clamps

Characteristics

- Re-usable tie mounting clamps
- For self-adhesive and / or screw- or rivet mounting
- One-piece design with integrated releasable lock
- The inner profile protects sensitive cables, fibre optics etc
- Desired height can be set in 3 or 6 ratchet steps
- The large base surface area and the strong adhesive film guarantee a high adhesive strength
- The self-adhesive film is foam backed (0.8 mm) which allows durable fixing on a variety of materials

Technical Information

Material	Polyamide 6.6
Temperature range	-40°C to +85°C (Self-adhesive version: 0°C to +65°C)
Colour	Natural
Mounting method	Self adhesive or screw-mounting
Flammability rating	UL 94 V-2
Other properties	Halogen free, Silicone free

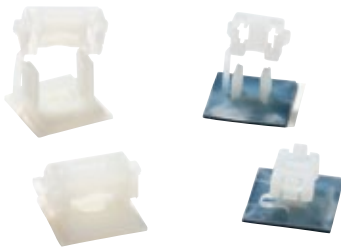

Product Ref.	Mounting method	Dimensions								Mounting hole diameter [mm]	Weight [g/100]	Quantity [pieces]
		H max. [mm]	H min. [mm]	W [mm]	L [mm]	D [mm]	E [mm]	F [mm]				
TC349A-TB	self-adhesive (rubber based) / screw	14.5	11.5	25.0	25.0	2.7	6 - 8.5	6	-	120	1000	
TC349AN	self-adhesive (acrylic based) / screw	14.5	11.5	25.0	25.0	2.7	6 - 8.5	6	-	120	1000	
TC5349A-TB	self-adhesive (rubber based) / screw	14.5	11.5	25.0	25.0	2.7	6 - 8.5	6	-	120	100	
TC350A-TB	self-adhesive (rubber based) / screw	22.0	18.0	25.0	25.0	4.7	6 - 12.5	15	4.3	400	1000	
TC350AN	self-adhesive (acrylic based) / screw	22.0	18.0	25.0	25.0	4.7	6 - 12.5	15	4.3	400	1000	
TC5350A-TB	self-adhesive (rubber based) / screw	22.0	18.0	25.0	25.0	4.7	6 - 12.5	15	4.3	400	100	
TC350	screw	21.3	17.2	25.0	25.0	4.0	6 - 12.5	15	4.3	380	1000	
TC5350	screw	21.3	17.2	25.0	25.0	4.0	6 - 12.5	15	4.3	380	100	

TC349A-TB
TC349AN
TC5349A-TB

TC350
TC350AN
TC5350
TC350A-TB
TC5350A-TB

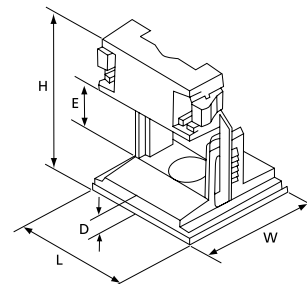
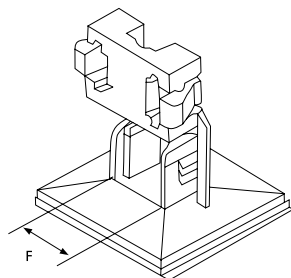

Cable clamps

Re-openable clamps

Characteristics

- Simple installation
- Can be mounted by clipping-in or gluing
- For series production or as a temporary support during wiring installation
- Clip ends are rounded for comfortable re-opening
- Product Ref. TC95 features 2-stage lock

Technical Information

Material	Polyamide 6.6
Temperature range	-40°C to +85°C
Colour	Natural
Mounting method	Clip in
Flammability rating	UL 94 V-2
Other properties	Halogen free, Silicone free



Product Ref.	Dimensions					For wall thickness from ... to [mm]	Mounting hole diameter [mm]	Weight [g/100]	Quantity [pieces]
	H [mm]	W [mm]	L [mm]	D [mm]	T [mm]				
TC88	22.6	12.7	19.1	12.7	2.5	2.5 - 3.6	5.7 - 7	115	100
TC95	40.5	12.7	19.1	25.4	2.5	2.5 - 3.6	5.7 - 7	278	100

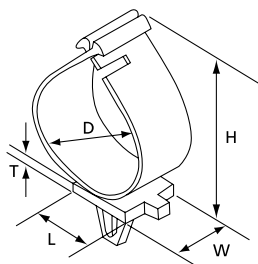

Cable clamps

Re-openable clamps with springs

Characteristics

- Holding clips with rubberised fabric tape
- The built-in springs hold the cable bundle safely in the desired position
- The upper clip end is rounded for easy addition of cables
- Strong fixing due to two mounting holes, aligned along the axis of the cable bundle

Technical Information

Material - Body	Polyamide 6.6
Material - Elastic	Rayon & natural rubber
Material - Spring	Steel
Temperature range	-40°C to +85°C
Colour	Natural
Mounting method	2 screws
Flammability rating	UL 94 V-2 (body)
Other properties	Halogen free



Product Ref.	Dimensions					Max. bundle diameter [mm]	Mounting hole diameter [mm]	Weight [g/100]	Quantity [pieces]
	H [mm]	L [mm]	W [mm]	E [mm]	F [mm]				
TC86	46	44.5	31.8	22.2	2.5	19	3.9	860	25
TC87	58	62.7	38.1	25.4	2.5	32	3.9	1950	25

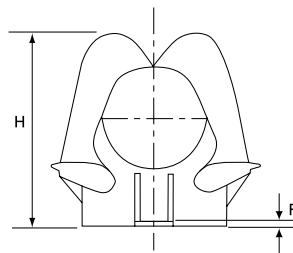
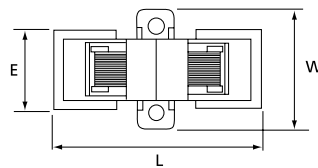

Cable clamps

Self-adhesive press clips

Characteristics

- Available in “full clip” version (PCNY series) or “half clip” version (HCNY series)
- 4 sizes to accommodate bundles up to 12 mm
- Clips are provided “two-up” on a rubber based closed cell foam adhesive

Technical Information

Material	Polyamide 6.6 (clip)
Temperature range	0°C to +65°C
Colour	Natural
Mounting method	Self-adhesive
Flammability rating	UL 94 V-2
Other properties	Halogen free, Silicone free

Product Ref.	Dimensions					Quantity [pieces]
	D [mm]	L [mm]	B [mm]	H [mm]	W [mm]	
FULL CLIP						
PCNY-125-9-D	3.17	19.30	9.65	5.36	9.52	500
PCNY-250-9-C	6.35	35.05	17.52	8.23	12.69	100
PCNY-250-9-D	6.35	35.05	17.52	8.23	12.69	500
PCNY-375-9-C	9.52	37.32	18.61	11.29	15.87	100
PCNY-375-9-D	9.52	37.32	18.61	11.29	15.87	500
PCNY-500-9-C	12.69	40.57	20.19	14.85	19.05	100
PCNY-500-9-D	12.69	40.57	20.19	14.85	19.05	500
HALF CLIP						
HCNY-125-9-C	3.17	12.52	9.65	4.57	9.52	100
HCNY-125-9-M	3.17	12.52	9.65	4.57	9.52	1000
HCNY-250-9-C	6.35	21.97	17.52	8.25	12.69	100
HCNY-250-9-M	6.35	21.97	17.52	8.25	12.69	1000
HCNY-375-9-C	9.52	24.88	19.05	10.54	15.87	100
HCNY-375-9-M	9.52	24.88	19.05	10.54	15.87	1000
HCNY-500-9-C	12.69	28.19	20.83	14.22	19.05	100
HCNY-500-9-M	12.69	28.19	20.83	14.22	19.05	1000

PCNY

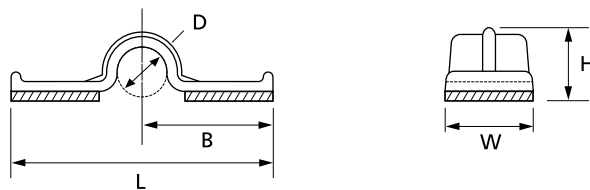

HCNY

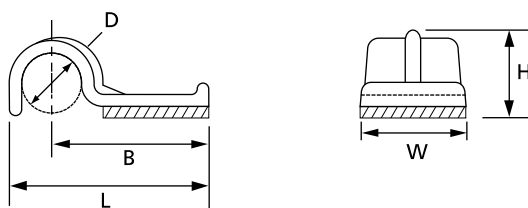

Cable clamps

Self-adhesive clips for round cable

Characteristics

- Diverse cable clamps for bundle diameters from 4 mm to 15.8 mm
- Clips are provided two-up on a rubber based closed cell foam adhesive
- Flexible centre tongue for removal or addition of cables

Technical Information

Material	Polyamide 6.6 (clip)
Temperature range	0°C to +65°C
Colour	Natural or black
Mounting method	Self-adhesive
Flammability rating	UL 94 V-2
Other properties	Halogen free, Silicone free



Product Ref.	Colour	Dimensions			Max. bundle diameter [mm]	Quantity [pieces]
		H [mm]	W [mm]	L [mm]		
RANY-160-9-D	natural	6.4	16.0	14.8	4.0	500
RANY-280-9-D	natural	10.4	25.4	25.4	7.1	500
RANY-280-0-D	black	10.4	25.4	25.4	7.1	500
RANY-530-9-D	natural	15.8	25.4	25.4	13.5	500
RANY-620-9-D	natural	14.2	31.8	28.5	13.5	500

For other colours and quantities please contact your Sales Office

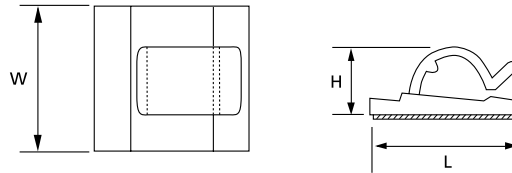

Cable clamps

Accessories for flat cables

Characteristics

- This system allows the secure and neat fixing of between 1 and 25 ribbon cables
- Clamp height adapts accurately to the desired number of ribbon cables
- Suitable for ribbon cables up to 60 conductors with a pitch of 1.27 mm (76.2 mm wide)
- Can be re-opened for later addition or removal of a cable
- Very strong hold
- All versions can be mounted with countersunk-head screws or rivets
- Some versions have an additional self-adhesive foam, for fast mounting

Technical Information

Material	Polyamide 6.6 (clip)
Temperature range	-40°C to +85°C (Self-adhesive version: 0°C to +65°C)
Colour	Natural
Mounting method	Self-adhesive and / or for screw- or rivet-mounting
Flammability rating	UL 94 V-2
Other properties	Halogen free, Silicone free



Product Ref.	Mounting method	Dimensions						Adhesive strength on steel/ fastening hole	Weight	Quantity
		H max.	H min.	W	L	D mounting centres from ... to	E inner width			
		[mm]	[mm]	[mm]	[mm]	[mm]	[mm]	[mm]	[g/100]	[pieces]
FCC-1	countersunk screws	21.0	8.0	12.7	32.5	-	25.4	M4	260	50
FCC-1A	countersunk screws / self-adhesive	21.0	8.8	12.7	32.5	-	25.4	76 N/cm	275	50
FCC-2	countersunk screws	36.0	8.0	12.7	57.9	39.1	50.8	M4	340	50
FCC-2A	countersunk screws / self-adhesive	36.0	8.8	12.7	57.9	39.1	50.8	76 N/cm	390	50
FCC-3	countersunk screws	36.0	8.0	12.7	83.3	64.5	76.2	M4	475	50
FCC-3A	countersunk screws / self-adhesive	36.0	8.8	12.7	83.3	64.5	76.2	76 N/cm	490	50

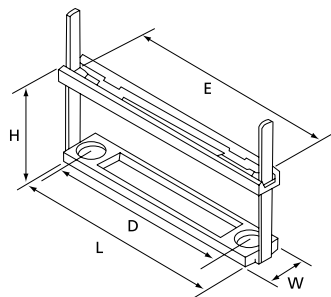

Accessories for flat cables

PVC cable-clips

Characteristics

- Low profile clip for single or multiple layers of flat ribbon cable
- "Single cut" on a rubber based closed cell foam adhesive

Technical Information

Material	PVC (clip)
Temperature range	0°C to +65°C
Colour	Grey
Mounting method	Self-adhesive
Flammability rating	UL 94 V-0 (clip)
Other properties	UV-resistant

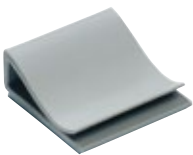

Product Ref.	Dimensions			Quantity
	H [mm]	T [mm]	W [mm]	
FRPV-1000-8-C	5.8	27	25.4	100
FRPV-1000-8-D	5.8	27	25.4	500

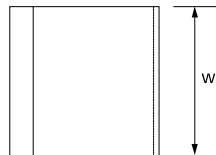
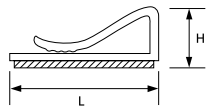

Accessories for flat cables

Clips with flexible leg

Characteristics

- Low profile clip for single or multiple layers of flat ribbon cable
- Flexible centre leg allows for easy removal and replacement of desired cable
- Non-conductive, non-corrosive, resistant to fuels, lubricants and most chemicals
- FANY supplied "two-up" on a rubber based closed cell foam adhesive
- FSNY type has an additional mounting hole for screw mounting (M4 screw)

Technical Information

Material	Polyamide 6.6 (clip)
Temperature range	-40°C to +85°C (Self-adhesive version: 0°C to +65°C)
Colour	Natural
Mounting method	Self-adhesive or screw
Flammability rating	UL 94 V-2 (clip)
Other properties	Halogen free, Silicone free



Product Ref.	Mounting method	Dimensions			Quantity [pieces]
		H [mm]	T [mm]	W [mm]	
FSNY-812-9-C	M4 screw	3.17	30.15	25.40	100
FANY-812-9-C	self-adhesive	7.14	25.40	25.40	100
FANY-812-9-D	self-adhesive	7.14	25.40	25.40	500

For other colours and quantities please contact your Sales Office

FANY

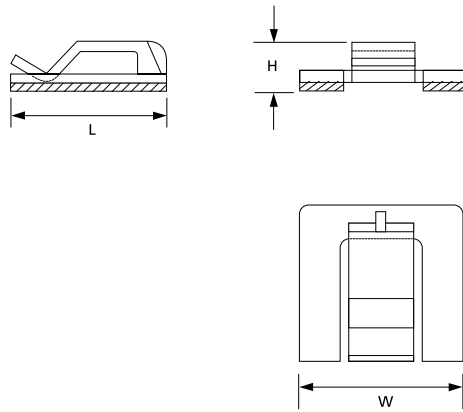

FSNY

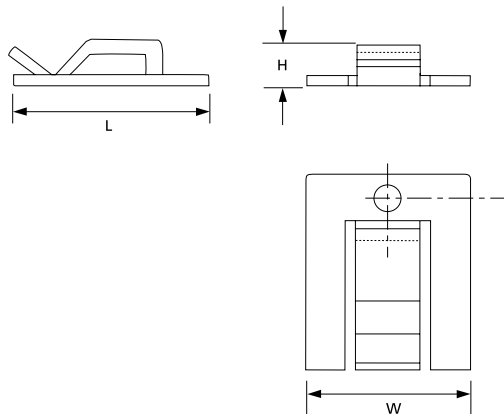



Cable sleeves and spiral wraps

Table of Content

Ty-Rap® High Performance Cable Ties	2
Ty-Fast® All-plastic cable ties	42
Ty-Met™ Stainless steel cable ties	66
Mounting bases and accessories	84
Cable protection systems	120
Wrap-around woven sleeving	124
Wrap-around woven sleeving - Flame retardant	125
Braided sleeving	126
Braided sleeving - Flame retardant	127
Spiral wrap	128
Extruded grommeting	129
Cable tie tooling	130
Material specifications	144

Cable sleeves and spiral wraps

Introduction



Cable sleeves and spiral wraps

Bind-It®

The Cable Protection Systems (CPS) from ABB captures different products:

- Wrap-around woven sleeving
- Braided sleeving
- Spiral wrap
- Extruded grommeting .

The wrap-around sleeving – better known under the name Bind-It® - is a tough but lightweight sleeve used to bundle and protect wires and cables from abrasion, sharp edges and chafing. Bind-It® is a self-wrapping sleeve that is very quick and easy to install and remove. Bind-It® is also available in a flame retardant version. No heat is necessary to seal the ends of this product. The ends can be secured by using Ty-Rap® cable ties.

The braided sleeving of ABB is used for bundling and protecting cables. The braided sleeving is a closed sleeve available in a flame and a non-flame retardant version. This product is mainly used inside cabinets and enclosures. To stop the end of the sleeving fraying it is necessary to heat seal the ends using a “hotwire” device.

Spiral wrap is mainly used for protection of bundles. This product is available in a natural and UV-resistant version and supplied in a Euroslot bag, ideal for the distribution market.

Finally the extruded grommeting of ABB is used to line panel edges and knock-outs where the chafing of passing wires is a concern. In most applications, grommeting will grip tightly by itself.

Cable sleeves and spiral wraps

Wrap-around woven sleeving

Characteristics

- Offers excellent protection for cable assemblies against abrasion
- No heat is required to seal the ends of this product as with traditional braided sleeving
- With its wrap-around design, it can be installed on assemblies where the wires are already terminated or wires need to be broken-out
- Bind-It® is available in nominal sizes from 5 mm to 38 mm

Technical Information

Material	Mono and multifilaments of polyester
Temperature range	-70°C to +125°C
Melt temperature	+255°C
Automotive temperature class	T3
Colour	Black
Flammability rating	Self-extinguishing, type B (FMVSS-302 Test method D45 1333)
Abrasion resistance	PSA D44 1722 : R8
Dielectric strength	from 1kVAC



Product Ref.	Nominal Size* [mm]	Length per mini-reel [m]
CPS05W-150-EU	5	150
CPS08W-100-EU	8	100
CPS13W-50-EU	13	50
CPS19W-25-EU	19	25
CPS25W-25-EU	25	25
CPS29W-15-EU	29	15
CPS32W-15-EU	32	15
CPS38W-15-EU	38	15

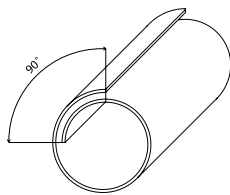

* Nominal size is determined by wrapping the product around a mandrel of a given size to obtain 90 degrees of overlap (average value).

Cable sleeves and spiral wraps

Wrap-around woven sleeving — Flame retardant

Characteristics

- Wrap-around sleeving manufactured from flame-retardant polyester monofilaments and multifilaments
- Designed for mechanical protection and maintenance of wire and cable bundles
- Its construction with 100% covering ratio provides excellent cut-through and abrasion resistance
- No heat is required to seal the ends of this product as with traditional braided sleeving
- With its wrap-around design, it can be installed on assemblies where the wires are already terminated or wires need to be broken-out
- Bind-It® is available in nominal sizes from 5 mm to 50 mm

Technical Information

Material	Mono and multifilaments of polyester
Temperature range	-50°C to +125°C
Melt temperature	+240°C
Automotive temperature class	T3
Colour	Black
Fire behaviour	According to EN 45545-2 : HL3 According to NF F 16 101 : I2-F1
Ignitability test	According to NF-EN-ISO 11925-2
Abrasion resistance	PSA D44 1722: R8
Smoke opacity	NFX 10-702-1; 10-702-2: Pass; Smoke index: 12
Index oxygen	According to EN 45545-2 : 37.5%
Dielectric strength	from 1kVAC
Other properties	Halogen free



Product Ref.	Nominal Size* [mm]	Length per mini-reel [m]
CPS05W-150-FR-EU	5	150
CPS08W-100-FR-EU	8	100
CPS13W-50-FR-EU	13	50
CPS19W-25-FR-EU	19	25
CPS25W-25-FR-EU	25	25
CPS29W-15-FR-EU	29	15
CPS32W-15-FR-EU	32	15
CPS38W-15-FR-EU	38	15
CPS50W-15-FR-EU	50	15

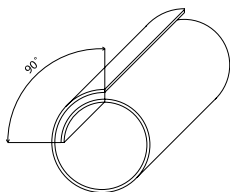

* Nominal size is determined by wrapping the product around a mandrel of a given size to obtain 90 degrees of overlap (average value).

Cable sleeves and spiral wraps

Braided sleeving

Characteristics

- Standard colour – black or grey
- Non-flame retardant Polyester rated at UL 94 V-2
- Available in nominal diameters from 3 to 50 mm to cover bundle diameters of 1 to 66 mm, giving flexibility when adding to or removing cables from wire looms
- For use in temperature ranges from -50°C to +150°C
- Good chemical resistance
- Halogen free
- For protecting and bundling cables and wires inside cabinets and enclosures



To stop the ends of the sleeving fraying it is necessary to heat seal the ends using a “hotwire” device. (Product Ref. WT-HSG)

Technical Information

Material	Polyester
Temperature range	-50°C to +150°C
Colour	Black or grey
Flammability rating	UL 94 V-2
Other properties	Good chemical resistance, Halogen free

1:2



Product Ref. Black	Product Ref. Grey	Nominal as supplied [mm]	Expandable diameter range [mm]	Length per mini-reel [m]
CPS3B-100	CPS3G-100	3	1 - 5	100
CPS4B-100	CPS4G-100	4	2 - 7	100
CPS5B-100	CPS5G-100	5	3 - 9	100
CPS6B-100	CPS6G-100	6	4 - 11	100
CPS8B-100	CPS8G-100	8	5 - 12	100
CPS10B-100	CPS10G-100	10	7 - 15	100
CPS12B-50	CPS12G-50	12	8 - 17	50
CPS15B-50	CPS15G-50	15	10 - 20	50
CPS20B-25	CPS20G-25	20	14 - 26	25
CPS25B-25	CPS25G-25	25	18 - 34	25
CPS30B-25	CPS30G-25	30	20 - 40	25
CPS40B-25	CPS40G-25	40	30 - 50	25
CPS50B-25	CPS50G-25	50	40 - 66	25

Cable sleeves and spiral wraps

Braided sleeving — Flame retardant

Characteristics

- Braided sleeving manufactured from flame-retardant polyester monofilaments
- Flame retardant polyester, conform to UL 94 V-0, mainly used in the railway industry
- Available in diameters from 3 to 50 mm to cover bundle diameters of 2 to 60 mm
- Recommended in applications such as public transportation, aircraft industry, telecommunications, underground cables, etc.

Technical Information

Material	Flame retardant polyester monofilaments (PET FR)
Temperature range	-50°C to +150°C
Melt temperature	+250°C
Colour	Black or grey
Tested according to	
- NF F 16 101	I2-F1
- EN45545-2 2013	HL3
Other properties	Halogen free

1:2



Product Ref. Black	Product Ref. Grey	Nominal as supplied [mm]	Expandable diameter range [mm]	Length per reel [m]
CPS3B-100-CV0	CPS3G-100-CV0	3	2 - 5	100
CPS4B-100-CV0	CPS4G-100-CV0	4	3 - 7	100
CPS5B-100-CV0	CPS5G-100-CV0	5	4 - 9	100
CPS6B-100-CV0	CPS6G-100-CV0	6	5 - 11	100
CPS8B-100-CV0	CPS8G-100-CV0	8	7 - 13	100
CPS10B-50-CV0	CPS10G-50-CV0	10	9 - 15	50
CPS12B-50-CV0	CPS12G-50-CV0	12	11 - 17	50
CPS15B-50-CV0	CPS15G-50-CV0	15	13 - 20	50
CPS20B-50-CV0	CPS20G-50-CV0	20	18 - 25	50
CPS25B-50-CV0	CPS25G-50-CV0	25	22 - 30	50
CPS30B-50-CV0	CPS30G-50-CV0	30	27 - 40	50
CPS40B-50-CV0	CPS40G-50-CV0	40	35 - 50	50
CPS50B-50-CV0	CPS50G-50-CV0	50	45 - 60	50

Cable sleeves and spiral wraps

Spiral wrap

Characteristics

- For protection of bundles from 4 mm to 130 mm
- Install gapped for greater flexibility or butted for maximum abrasion resistance, insulation and rigidity
- Counter-clockwise cut
- Delivered in bags with Euroslot
- Available in natural and UV-resistant black Polyethylene

Technical Information

Material	Polyethylene
Temperature range	+30°C to +80°C
Colour	Natural and UV-resistant black
Flammability rating	UL 94 HB
Other properties	UV-resistant black, Halogen free, Silicone free



Product Ref.	Colour	Outer diameter [mm]	Pitch [mm]	Nominal thickness [mm]	Min. - max. bundle diameter [mm]	Length [m]
SRPE-6-9	natural	6.0	7.0	0.5	4 - 50	10
SRPE-8-9	natural	8.0	10.8	0.5	6 - 60	10
SRPE-10-9	natural	10.0	11.4	0.8	7.5 - 60	10
SRPE-12-9	natural	12.0	13.9	0.9	9 - 65	10
SRPE-15-9	natural	15.0	15.0	1.0	12 - 70	10
SRPE-19-9	natural	19.0	18.2	1.3	15 - 100	10
SRPE-24-9	natural	24.0	19.6	1.5	20 - 130	10
SRPE-6-0	UV-resistant black	6.0	7.0	0.5	4 - 50	10
SRPE-8-0	UV-resistant black	8.0	10.8	0.5	6 - 60	10
SRPE-10-0	UV-resistant black	10.0	11.4	0.8	7.5 - 60	10
SRPE-12-0	UV-resistant black	12.0	13.9	0.9	9 - 65	10
SRPE-15-0	UV-resistant black	15.0	15.0	1.0	12 - 70	10
SRPE-19-0	UV-resistant black	19.0	18.2	1.3	15 - 100	10
SRPE-24-0	UV-resistant black	24.0	19.6	1.5	20 - 130	10

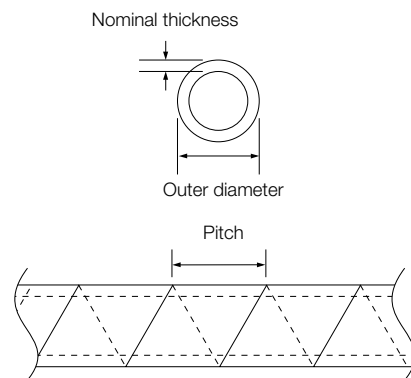

Cable sleeves and spiral wraps

Extruded grommets

Characteristics

- Used to line panel edges and knock-outs where the chafing of passing wires is a concern
- Available in 8 stock sizes in 30.5 m lengths for panels from 1 mm to 6.35 mm
- In most applications, grommets will grip tightly by itself, if not, a touch of Epoxy will keep it in place

Technical Information

Material	Polyamide 6.6
Temperature range	-40°C to +85°C
Colour	Natural or black
Flammability rating	UL 94 V-2
Other properties	Halogen free, Silicone free



Product Ref.	Colour	Internal width A [mm]	Thickness T [mm]	H [mm]	W [mm]	Length per reel [m]
GRNY-040-9-C	natural	1.01	1.01	4.82	3.17	30.5
GRNY-052-9-C	natural	1.32	1.01	4.82	3.17	30.5
GRNY-062-9-C	natural	1.57	1.14	5.08	4.32	30.5
GRNY-085-9-C	natural	2.15	1.14	5.08	4.32	30.5
GRNY-100-9-C	natural	2.54	1.14	5.58	5.33	30.5
GRNY-125-9-C	natural	3.17	1.27	5.58	5.23	30.5
GRNY-187-9-C	natural	4.74	1.27	6.85	6.98	30.5
GRNY-250-9-C	natural	6.35	1.27	7.11	9.39	30.5
GRNY-040-0-C	black	1.01	1.01	4.82	3.17	30.5
GRNY-052-0-C	black	1.32	1.01	4.82	3.17	30.5
GRNY-062-0-C	black	1.57	1.14	5.08	4.32	30.5
GRNY-085-0-C	black	2.15	1.14	5.08	4.32	30.5
GRNY-100-0-C	black	2.54	1.14	5.58	5.33	30.5
GRNY-125-0-C	black	3.17	1.27	5.58	5.23	30.5
GRNY-187-0-C	black	4.74	1.27	6.85	6.85	30.5
GRNY-250-0-C	black	6.35	1.27	7.11	9.39	30.5

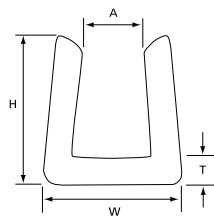



Cable Tie Tooling

Table of Content

Ty-Rap® High Performance Cable Ties	2
Ty-Fast® All-plastic cable ties	42
Ty-Met™ Stainless steel cable ties	66
Mounting bases and accessories	84
Cable protection systems	120
Cable tie tooling	130
Selection guide	132
Tools for plastic cable ties	136
Tools for stainless steel ties	140
Material specifications	144

Cable Tie Tooling Introduction



Cable Tie Tooling

Ty-Rap® and Ty-Met™ tooling

ABB offers a comprehensive range of tooling to complement the full range of cable ties.

The range includes low-cost tools for maintenance and small batch requirements, as well as robust and ergonomic tools with tension setting and automatic cutting, now also in pneumatic version

In particular, the ERG50 and ERG120 hand tools, as well as the new ERG50P pneumatic tool, provide a superior level of reliability and performance, combined with enhanced ergonomics and comfort of use.

These ergonomic tools, with adjustable tension and automatic cutting, are ideally suited for efficiently installing all kinds of plastic cable ties in industrial (Original Equipment Manufacturers, Maintenance and Repair Organisations, etc) and construction applications.

ERG50, ERG50P & ERG120

Superior reliability and performance

- Developed to meet the market needs for a more rugged and longer lasting tool
- Designed to integrate the greatest number of features in the market

Enhanced ergonomics and comfort of use

- First class design and materials, for maximum convenience
- As a result, the operator is subject to less stress, less fatigue and less risk of trauma due to long term use (such as Carpal Tunnel Syndrome)
- The pneumatic version (ERG50P) provides an even increased comfort of use

Increased efficiency

- Exclusive features for quick set-up and fast installation
- Confidence to achieve a highly professional result, installation after installation

Cable Tie Tooling

Selection guide



Product Ref.	Features	Tensioning	Cutting	For cable ties
TOOLING FOR PLASTIC TIES				
ERG50	Ergonomic hand tool with superior level of reliability and performance	adjustable	automatic	2.4 mm - 4.8 mm
ERG120	Ergonomic hand tool with superior level of reliability and performance	adjustable	automatic	4.8 mm - 7.6 mm
ERG50P	Ergonomic pneumatic tool with superior level of reliability and performance	adjustable	automatic	2.4 mm - 4.8 mm
WT199	Semi- automatic MIL specified hand tool (MIL. Nr. MS-90387-1)	adjustable	automatic	2.4 mm - 4.8 mm
WT1-TB	Basic tensioning tool, intended for maintenance and small batch use	basic	twist cut	2.4 mm - 4.8 mm
WT197	Semi-automatic MIL specified hand tool (MIL. Nr. MS-90387-2)	adjustable	automatic	4.8 mm - 7.6 mm
WT2-TB	Basic tensioning tool, intended for maintenance and small batch use	basic	twist cut	4.8 mm - 7.6 mm
L300-FR	Rugged construction with field proven durability	basic	manual	7.6 mm - 9 mm
WT3D	Robust metal body with plastic hand-grips, designed for tensioning and cutting heavy-duty cable ties	basic	twist cut	7.6 mm - 12.7 mm
L-500-EU	Rugged metallic construction	adjustable	automatic	4.7 mm - 13.3 mm

Cable Tie Tooling Selection guide



Product Ref.	Features	Tensioning	Cutting	For cable ties
TOOLING FOR TY-MET™ STAINLESS STEEL TIES				
CT1-TB	Tensioning hook provides extra-leverage for tensioning the ties by hand	basic	no cutting	Releasable, Ladder Type & Strap Type
CT2-TB	Basic hand tool	basic	no cutting	Releasable, Ladder Type & Strap Type
WT3S	A robust metallic hand tool with rubber grips	basic	no cutting	Ladder Type & Strap Type
CT3	Economic tensioning tool	basic	manual	Ladder Type, Strap Type & Ball-Lock Type (width up to 12 mm)
L-600	Tensioning tool	basic	manual (twist cut)	Ball-Lock Type (width: 4.6 mm & 7.9 mm)
CT4-TB	Bantam tool, unique 3-way handle can be used in various positions. Especially useful in tight areas with minimal access	basic	manual	Releasable, Ladder Type & Strap Type
CT5	Adjustable tension setting tool with automatic cutting	adjustable	automatic	Ladder Type & Strap Type
CT6	Adjustable tension setting tool with automatic cutting	adjustable	automatic	Ball-Lock Type (width: 4.6 mm & 7.9 mm)
CT7	Tensioning and cutting tool, ratchet type	basic	manual	Ball-Lock Type (width: 12mm & 16mm)
CT8	Tensioning and cutting tool, ratchet type	basic	manual	Bands on reel (all widths)

Cable Tie Tooling

Tools for plastic cable ties: ERG50, ERG120 and ERG50P

Characteristics

The ergonomic tools from ABB provide a superior level of reliability and performance, combined with enhanced ergonomics and comfort of use. With their adjustable tension and automatic cutting, they are ideally suited for efficiently installing all kinds of plastic cable ties in industrial (Original Equipment Manufacturers, Maintenance and Repair Organisations, etc) and construction applications. They are available in hand tool version (ERG50 and ERG120) and in pneumatic version (ERG50P) for higher volumes of installation without muscle strain.

Developed to meet the market needs for a more rugged and longer lasting tool, and to integrate the greatest number of features in the market:

- 360° rotating nose (patented), allows the tool to be used in any position
- Tension adjustment lock, for constant tension setting
- Quick tension-adjustment wheel located towards the front for easy access and fast changes
- Adjustable handle span (for hand tools only) fits large and small hands.
- Anti-recoil mechanism (patented) reduces vibration shock
- First class design and materials: ergonomic shape with rounded edges, soft rubber handles, well balanced center of gravity
- Longest stroke length on the market (25.4 mm), meaning less tensioning cycles, for time and cost saving
- High / low force setting (patent pending), for a selection between “high force & long stroke” or “low force & short stroke” (for hand tools only)
- The cable tie is cut flush to the head, with no remaining protrusion, and the cut tail remains captive in the tool for a cleaner installation
- Easy access to spare blade nest, always a spare blade at hand (each tool is supplied with a spare blade)

As a result, the operator is subject to less stress, less fatigue and less risk of trauma due to long term use (such as Carpal Tunnel Syndrome)



Technical Information ERG50

Tool type	Ergonomic hand tool
Nose colour	Black
For type of cable tie	Plastic ties
For tie width	2.4 mm - 4.8 mm
Features	Adjustable tension setting, automatic cutting, retraction of the strap end after application of Ty-Rap® cable ties
Weight	260 g
Dimensions [L x W x H]	178 x 127 x 38 mm
Replacement blades	Product Ref. ERG50B



Technical Information ERG120

Tool type	Ergonomic hand tool
Nose colour	Orange
For type of cable tie	Plastic ties
For tie width	4.8 mm - 7.6 mm
Features	Adjustable tension setting, automatic cutting, retraction of the strap end after application of Ty-Rap® cable ties
Weight	278 g
Dimensions [L x W x H]	178 x 127 x 38 mm
Replacement blades	Product Ref. ERG120B



Technical Information ERG50P

Tool type	Ergonomic pneumatic tool
Nose colour	Black
For type of cable tie	Plastic ties
For tie width	2.4 mm - 4.8 mm
Features	Adjustable tension setting, automatic cutting, retraction of the strap end after application of Ty-Rap® cable ties, double hangers, supplied with pneumatic hose (2.7 metre)
Operating air pressure	6 to 7 bar non-lubricated air
Weight	415 g (without pneumatic hose)
Dimensions [L x W x H]	245 x 155 x 40 mm
Replacement blades	Product Ref. ERG50B

Cable Tie Tooling

Tools for plastic cable ties

Product Ref.: WT199



Characteristics

- Semi- automatic hand tool
- MIL. Nr. MS-90387-1
- Tension setting to ensure product consistency
- Robust metal construction
- Ideal for industrial mass finishing applications like cable tree assemblies, for example in the military industry

Technical Information

Tool type	Semi-automatic hand tool
For type of cable tie	Plastic ties
For tie width	2.4 mm - 4.8 mm
Features	Adjustable tension setting, automatic cutting, MIL specified (MS-90387-1)
Weight	410 g
Dimensions [L x W x H]	163 x 134 x 24 mm

Product Ref.: WT197



Characteristics

- Semi-automatic hand tool
- MIL. Nr. MS-90387-2
- Tension setting to ensure product consistency
- Robust metal construction
- Ideal for industrial mass finishing applications like cable tree assemblies, for example in the military industry

Technical Information

Tool type	Semi-automatic hand tool
For type of cable tie	Plastic ties
For tie width	4.8 mm - 7.6 mm
Features	Adjustable tension setting, automatic cutting, MIL specified (MS-90387-2)
Weight	420 g
Dimensions [L x W x H]	165 x 135 x 29 mm

Cable Tie Tooling

Tools for plastic cable ties

Product Ref.: WT3D

Characteristics

- Designed for tensioning and cutting heavy-duty cable ties
- Robust metal body with plastic hand-grips

Technical Information



Tool type	Hand tool for Deltec® ties, Col-Ty™ installation ties and other wide cable ties
For type of cable tie	Plastic ties
For tie width	7.6 mm - 12.7 mm
Features	Tensioning, manual cutting (by twisting the tool)
Weight	225 g
Dimensions [L x W x H]	178 x 112 x 20 mm

Product Ref.: L-500-EU

Characteristics

- Rugged metallic construction makes this tool ideal for use with our 4.7 mm to 13.3 mm wide ties
- Set tension adjuster to give desired tie tightness
- Pull trigger and tie is automatically tensioned and cut



Technical Information

Tool type	Hand tool
Colour	Red
For type of cable tie	Plastic ties
For tie width	4.7 mm - 13 mm
Features	Tensioning, automatic cutting
Weight	320 g
Dimensions [L x W x H]	220 x 90 x 25 mm

Product Ref.: L300-FR

Characteristics

- Rugged construction makes this tool ideal for use with our 3.6 mm to 9 mm wide ties
- Pull tie to desired tension and pull trigger to cut excess flush at cable tie head
- Field proven durability

Technical Information



Tool type	Hand tool for Col-Ty™ installation ties and other wide cable ties
Colour	White
For type of cable tie	Plastic ties
For tie width	3.6 mm - 9 mm
Features	Tensioning, manual cutting
Weight	330 g
Dimensions [L x W x H]	195 x 100 x 25 mm

Cable Tie Tooling

Tools for plastic cable ties

Product Ref.: WT1-TB

Characteristics

- Twist-and-cut tensioning tool in plastic, intended for maintenance and small batch use

Technical Information



Tool type	Low-cost hand tool
Colour	Orange
For type of cable tie	Plastic ties
For tie width	2.4 mm - 4.8 mm
Features	Basic tensioning, twist cut
Weight	28.4 g
Dimensions [L x W x H]	134 x 55 x 27 mm

Product Ref.: WT2-TB

Characteristics

- Twist-and-cut tensioning tool in plastic, intended for maintenance and small batch use

Technical Information



Tool type	Low-cost hand tool
Colour	Black
For type of cable tie	Plastic ties
For tie width	4.8 mm - 7.6 mm
Features	Basic tensioning, twist cut
Weight	28.4 g
Dimensions [L x W x H]	134 x 55 x 27 mm

Cable Tie Tooling

Tools for stainless steel ties

Product Ref.: CT1-TB

Characteristics

- Tensioning hook suitable for Releasable Type, Ladder Type and Strap type stainless steel ties
- Provides extra-leverage for tensioning the ties by hand

Technical Information

Tool type	Hand tool
For type of cable tie	Releasable Type, Ladder Type & Strap Type stainless steel ties
Features	Tensioning, no cutting
Weight	50 g
Dimensions [L x W x H]	85 x 106 x 15 mm



Product Ref.: CT2-TB

Characteristics

- Cable tie tensioner suitable for Releasable Type, Ladder Type & Strap type ties
- Tensions the ties to their optimum holding power with a simple squeeze: a flick of the wrist and they're locked tight

Technical Information

Tool type	Hand tool
For type of cable tie	Releasable Type, Ladder Type & Strap Type stainless steel ties
For tie width	Up to 12 mm
Features	Tensioning, no cutting
Weight	300 g
Dimensions [L x W x H]	195 x 90 x 30 mm



Product Ref.: WT3S

Characteristics

- A robust metallic hand tool with rubber grips designed for tensioning Ladder Type & Strap Type stainless steel ties
- After tensioning, the stainless steel ties can easily be cut with side-cutters

Technical Information

Tool type	Hand tool
For type of cable tie	Ladder Type & Strap Type stainless steel ties
For tie width	Up to 12 mm
Features	Tensioning, no cutting
Weight	225 g
Dimensions [L x W x H]	178 x 112 x 20 mm



Cable Tie Tooling

Tools for stainless steel ties

Product Ref.: CT3

Characteristics

- Cost-effective tensioning tool
- Cut-off by hand-activated lever

Technical Information

Tool type	Hand tool
For type of cable tie	Ladder Type, Strap Type & Ball Lock Type stainless steel ties, coated and uncoated
For tie width	Up to 12 mm
Features	Tensioning, manual cutting
Weight	550 g
Dimensions [L x W x H]	210 x155 x 35 mm



Product Ref.: L-600

Characteristics

- Tensioning tool with twist cut

Technical Information

Tool type	Hand tool
For type of cable tie	Ball Lock Type stainless steel ties, coated and uncoated
For tie width	4.6 - 7.9 mm
Features	Tensioning, manual cutting (by twisting the tool)
Weight	600 g
Dimensions [L x W x H]	200 x 140 x 40 mm



Product Ref.: CT4-TB

Characteristics

- Bantam tool, suitable for Releasable Type, Ladder Type & Strap Type stainless steel ties
- Unique 3-way handle can be used in various positions. Especially useful in tight areas with minimal access

Technical Information

Tool type	Hand tool
For type of cable tie	Releasable Type, Ladder Type & Strap Type stainless steel ties
Features	Tensioning, manual cutting
Weight	1200 g
Dimensions [L x W x H]	156 x 180 x 80 mm



Cable Tie Tooling

Tools for stainless steel ties

Product Ref.: CT5

Characteristics

- Suitable for coated and uncoated Ladder Type & Strap Type stainless steel ties
- Adjustable tension settings
- Automatic cutting once desired tension has been reached



Technical Information

Tool type	Tension setting hand tool
For type of cable tie	Ladder Type & Strap Type stainless steel ties, coated and uncoated
For tie width	Up to 12 mm
Features	Adjustable tension setting, automatic cutting
Weight	430 g
Dimensions [L x W x H]	173 x 158 x 22 mm

Product Ref.: CT6

Characteristics

- Suitable for coated and uncoated Ball-Lock Type stainless steel ties
- Adjustable tension settings
- Automatic cutting once desired tension has been reached



Technical Information

Tool type	Tension setting hand tool
For type of cable tie	Ball-Lock Type stainless steel ties, coated and uncoated
For tie width	4.6 - 7.9 mm
Features	Adjustable tension setting, automatic cutting
Weight	430 g
Dimensions [L x W x H]	173 x 158 x 22 mm

Cable Tie Tooling

Tools for stainless steel ties

Product Ref.: CT7

Characteristics

- Tensioning and cutting tool, ratchet type
- Suitable for coated and uncoated Ball-Lock Type stainless steel ties, having a width of 12 mm and 16 mm



Technical Information

Tool type	Hand tool, ratchet type
Weight	1300 g
Dimensions [L x W x H]	270 x 170 x 60 mm

Product Ref.: CT8

Characteristics

- Tensioning and cutting tool, ratchet type
- Suitable for the bands on reel, in all widths
- The long nose leaves an excess of 45 mm after the tie is cut, for an easy installation of the band on reel



Technical Information

Tool type	Hand tool, ratchet type
For type of cable tie	Bands on reel
For tie width	All widths (up to 19.1 mm)
Weight	1570 g
Dimensions [L x W x H]	310 x 200 x 60 mm



Material specifications

Table of Content

Ty-Rap® High Performance Cable Ties	2
Ty-Fast® All-plastic cable ties	42
Ty-Met™ Stainless steel cable ties	66
Mounting bases and accessories	84
Cable protection systems	120
Cable tie tooling	130
Material specifications	144
UL flammability ratings	146
Adhesive material specifications	147
Material selection and specifications	148
Unit conversion factors	155

Material specifications

UL flammability ratings

Flammability ratings for selecting cable ties

Note: Flammability ratings of cable tie materials per UL as follows. These tests for flammability of plastic material are intended to serve as a preliminary indication of acceptability with respect to flammability for particular applications.

UL 94 vertical burn test procedures

Test specimens of the material, with dimensions 127 x 12.7 mm (5»x 1/2»), with the thickness intended for use in the end product, are tested in both the manufactured condition and in the aged state. The test requires that the specimen be supported in a vertical fixture and a precisely controlled flame applied for a 10 second period. The flame is removed and the duration of flaming is noted. If the flame extinguishes, a second exposure to flame for 10 seconds is applied and duration of flaming is again noted. It is observed and recorded whether or not test specimens drip flaming particles that ignite a cotton swab.

Materials classed 94 V-0:

A material classed 94 V-0 shall:

- A Not have any specimens that burn with flaming combustion for more than 10 seconds after either application of the test flame
- B Not have a total flaming combustion time exceeding 50 seconds for the 10 flame applications for each set of five specimens
- C Not have any specimens that burn with flaming or glowing combustion up to the holding fixture
- D Not have any specimens that drip flaming particles that ignite the dry absorbent surgical cotton located 304.8 mm (12») below the test specimen
- E Not have any specimens with glowing combustion that persists for more than 30 seconds after the second removal of the test flame

Materials classed 94 V-1:

A material classed 94 V-1 shall:

- A Not have any specimens that burn with flaming combustion for more than 30 seconds after either application of the test flame
- B Not have a total flaming combustion time exceeding 250 seconds for the 10 flame applications for each set of five specimens
- C Not have any specimens that burn with flaming or glowing combustion up to the holding fixture
- D Not have any specimens that drip flaming particles that ignite the dry absorbent surgical cotton located 304.8 mm (12») below the test specimen
- E Not have any specimens with glowing combustion that persists for more than 60 seconds after the second removal of the test flame.

Materials classed 94 V-2:

A material classed 94 V-2 shall:

- A Not have any specimens that burn with flaming combustion for more than 30 seconds after either application of the test flame
- B Not have a total flaming combustion time exceeding 250 seconds for the 10 flame applications for each set of five specimens
- C Not have any specimens that burn with flaming or glowing combustion up to the holding fixture
- D Be permitted to have specimens that drip flaming particles that burn only briefly, some of which ignite the dry absorbent surgical cotton placed 304.8 mm (12») below the test specimen
- E Not have any specimens with glowing combustion that persists for more than 60 seconds after the second removal of the test flame

UL 94 horizontal burn (HB) test procedures

The test uses a 1/2 inch x 5 inches (12.7 mm x 127 mm) specimen held at one end in a horizontal position with marks at 1 inch (25.4 mm) and 5 inches (127 mm) from the free end. A flame is applied to the free end for 30 seconds or until the flame front reaches the 1 inch (25.4 mm) mark. If combustion continues the duration is timed between the 1 inch (25.4 mm) mark and the 5 inch (127 mm) mark. If combustion stops before the 5 inch (127 mm) mark, the time of combustion and the damaged length between the two marks are recorded. A set of three specimens are tested.

Materials classed 94 HB

A material that is less than 0.118 inch (3 mm) in thickness will be classified 94HB if it has a burning rate of less than 3 inches (76.2 mm) per minute or stops burning before the 5 inches (127 mm) mark. If one specimen from the set of three fails to comply, then a second set of three are tested. All three of this second set must comply. HB rated materials are considered "self-extinguishing". This is the lowest (least flame retardant) UL94 rating.

Nylon 6.6 = Polyamide 6.6 is Halogen-free and Silicone-free.

Material specifications

Adhesive material specifications

Property	Method	Unit of measure	Rubber based (self-adhesive)	Acrylic based (2 component glue)
Coated Sides	–	each	2	2
Foam Density	–	Kg/m3	96.9	96.9
Peel Adhesion	PSTC 1	N/cm width	10.9	10
	ASTM D 1000	Average		8.8
Shear Adhesion	natural	15.0	15.0	10
22°C 50% RH	PSTC 7	Hours	100 +	8 +
22°C Occasional Wetting		N/m2	68971	15174
Tensile Strength	ASTM D 412	PSI	100	100 +
Tear Resistance	ASTM D 624	N/cm	52.6	52.6 +
Elongation at Break	–	%	400	200
Service Temperature	–	°C Min	-18	-29
	–	°C Max	+66	+79
Flammability	ASTM D 624		Slow Burn	Slow Burn

Installation instructions for self-adhesive mounting bases

- Mounting surfaces should be cleaned with alcohol based (IPA) cleaner before application
- The self-adhesive mounting bases have a double-sided adhesive tape made of synthetic foam, covered by a protecting foil.
- To install the self-adhesive mounting base, remove the protecting foil and press the mounting base onto the cleaned surface
- The thickness of the self-adhesive foam (0.8 mm) compensates the irregularities of the application surfaces and allows installations on structured surfaces of cabinet doors, on sheet metal, on machines, etc
- The adhesion is achieved immediately during the installation, which means that later repositioning is not possible

Product Ref.: TC2PA

Characteristics

- 2 component glue
- Consists of one tube each of adhesive and activator
- Easy application
- Stable and durable adhesion
- Applicable on all Polyamide and Aluminium mounting bases and cable clamps
- Also applicable on concrete and other porous surfaces
- UV resistant

Technical Information

Description 2 component glue
Weight 0.21 kg

Installation instructions for Product Ref. : TC2PA (2 component glue)

- Mounting surfaces should be cleaned before application
- The liquid adhesive in the tube is to be spread onto the mounting surface. It can be used on most rough surfaces (like concrete)
- The activator liquid is then spread onto the surface of the mounting base
- Place the surface of the mounting base in contact with the surface where it has to be mounted, position the mounting base correctly and then press firmly
- Repositioning the mounting base remains possible only for a few seconds
- Do not use the mounting base immediately after installation. The Acrylic-based adhesive requires a set-up time that can be influenced by factors such as temperature (allow 24 - 72 hours for maximum performance)
- Temperature of installation needs to be above +20°C

Material specifications

Material selection and specifications

Selecting the right material for your applications

ABB offers cable ties and accessories in a wide variety of materials, each suited for specific environments. The purpose of this document, therefore, is to assist in choosing the best material for a particular application.

The effects of weathering, flame, chemicals, extreme temperatures and radiation on the different materials is clearly presented in tabular form. This will facilitate the choice of the best material for the application.

Having determined the most suitable material, one can choose from the wide variety of cable ties, identification ties, mounting bases, lashing ties, etc., offered by ABB.

Polyamide 6.6

- Thermoplastic material used in cable ties for universal applications in the industry
- Excellent resistance to shocks, chemicals, oils and temperature fluctuations
- High surface hardness and a small coefficient of friction
- Flammability rating: UL 94 V-2
- Halogen free and Silicone free
- Indoor applications
- Ty-Fast® ties in standard Polyamide 6.6 are available in natural colour and in a wide range of colours
- Ty-Rap® ties in standard Polyamide 6.6 are available in natural colour only

Polyamide 6.6, weather resistant

- Similar to Polyamide 6.6, but recommended for outdoor applications
- UV-resistant
- Halogen free and Silicone free
- Ty-Fast® ties in weather resistant Polyamide 6.6 are available in black colour only (with 2 % carbon for military specifications)
- Ty-Rap® ties in weather resistant Polyamide 6.6 are available in black colour (with 2 % carbon for military specifications) and in a wide range of colours (except natural)
- Flammability rating: UL 94 V-2



Polyamide 6.6, heat stabilised

- Similar to Polyamide 6.6, but increased operating temperatures, up to 105°C
- Excellent tensile strength
- High temperature resistance
- Colour: natural (may have a greenish tint)
- Flammability rating: UL 94 V-2



Material specifications

Note: Nylon (Polyamide) is inherently susceptible to environmental conditions. Polyamide 6.6 cable ties are moisturised to optimum performance levels at machine-side and should be stored in cool dry areas out of direct sunlight. Cable ties are packaged in plastic bags to contain moisture and should remain sealed until ready for use.

Polyamide 6.6, heat stabilised and UV-resistant

- Similar to Polyamide 6.6, but recommended for outdoor applications and/or high temperature applications, up to 105°C
- Combines the features & benefits of Polyamide 6.6, weather resistant and Polyamide 6.6, heat stabilised
- Colour: black
- Flammability rating: UL 94 V-2



Polyamide 6.6, flame retardant

- Excellent flammability rating: UL 94 V-0
- Ideal in areas where human life is at risk
- Colour: white



Polyamide 6.6, detectable

- Similar to Polyamide 6.6, but contains a compound detectable by metal detectors (tested and rated at 1.5 mm diameter ferrous sphere setting) and X-ray equipment
- Colour: bright blue, also contributes to visual detection
- Especially recommend for the food industry, and for any other contamination sensitive industry using detection equipment
- Halogen free and silicone free
- Flammability rating: UL 94 V-2



Polyamide 4.6, extra high temperature (150°C)

- Similar to Polyamide 6.6, but outstanding resistance to high temperatures up to 150°C
- Halogen free and silicone free
- Colour: light green
- Flammability rating: UL 94 V-2



Polyamide 12, weather resistant

- Extremely flexible, also at low temperatures
- Ages better than Polyamide 6.6
- UV-resistant and weatherproof
- Better chemical resistance than Polyamide 6.6
- Colour: black
- Flammability rating: UL 94 V-2



ECTFE Fluoropolymer

- Similar to ETFE Fluoropolymer in performance
- Outstanding characteristic: lower smoke density when burnt
- Recommended for applications where smoke generation is a concern, such as plenum areas
- Colour: maroon
- Flammability rating: UL 94 V-0



Polypropylene, weather resistant

- Resistant against inorganic acids, polyhydric alcohols, neutral and basic salts
- Resists a number of other chemicals
- UV resistant
- Lower tensile strength than Polyamide 6.6
- Colour: black
- Flammability rating: UL 94 HB



Toughened weatherable acetal

- Excellent resistance to a wide variety of solvents, esters, oils, greases, gasoline and other petroleum hydrocarbons
- Resistant to weak acids and bases
- Excellent resistance to UV (weatherable acetal)
- Limited self-extinguishing properties
- Colour: black
- Flammability rating: UL 94 HB



Polypropylene, detectable

- Similar to standard Polypropylene, but contains a compound detectable by metal detectors (tested and rated at 1.5 mm diameter ferrous sphere setting) and X-ray equipment
- Colour: bright blue, also contributes to visual detection
- Especially recommend for the food industry, and for any other contamination sensitive industry using detection equipment
- Halogen free and silicone free
- Flammability rating: UL 94 HB



302/304 Stainless Steel, 316 Stainless Steel

- Superior corrosion resistance
- Excellent tensile strengths at extreme temperatures
- High resistance to chemicals, acids and radiation
- 316 grade has a better resistance to saltwater corrosion and can be supplied with a halogen free coating
- Extensively used in offshore, rail and petrochemical industries



ETFE Fluoropolymer

- Tensile strength slightly lower than Polyamide 6.6
- ETFE Fluoropolymer is inert to most solvents and chemicals, hydrolytically stable, UV and weather resistant
- Radiation resistant (meets IEEE383) and approved for nuclear plant use
- Non-outgassing properties for zero gravity applications
- Very high temperature resistance
- Flammability rating: UL 94 V-0
- The best all around plastic material for cable ties
- Colour: aquamarine



Material specifications

Material selection and specifications

General

There is a number of factors to be considered when choosing the proper materials for a specific environment. It is extremely difficult to provide data on all the possible combinations or conditions that can occur and therefore, it is recommended that this information be used as a guideline and that cable tie samples be tested in the intended application, by the user, to determine suitability.

How to use the table

If your application is in an extremely cold environment, three materials will answer your need: ETFE Fluoropolymer, Polyamide 12 and stainless steel. If you also require high tensile strength, then stainless steel is your best choice. Where high strength is not required, Polyamide 12 might be your choice as it is the less costly.

This information is based on data provided by the manufacturers of the specific materials listed and is provided only as a general guide. No specific recommendation is intended. As each application may vary, testing should be conducted by the user in the intended environment.

Table 1 gives relative performance ratings of the different materials we offer. Chemical resistance is shown in Table 2

Table 1 - Information on cable tie materials

Material Code	Polyamide 6.6	Polyamide 6.6 weather resistant*	Polyamide 6.6 heat stabilised	Polyamide 6.6 heat stabilised UV resistant	Polyamide 6.6 flame retardant
	PA6.6	UV PA6.6	HS PA6.6	HSUV PA6.6	FR PA6.6
Ty-Rap® Product Ref.	TY...M	TY...MX	TYH...M	TY...MXA	TY...MFR
Ty-Fast® Product Ref.	TY...	TY..X	TY..39		TS...HF
Max. operating temperature	+85°C	+105°C	+105°C	+105°C	+65°C
Min. operating temp.	-60°C	-60°C	-60°C	-60°C	-20°C
UL flammability rating	V-2	V-2	V-2	V-2	V-0
Specific density	1.14	1.14	1.14	1.14	1.16
Water absorption (24h/ASTM)	2.5 - 3.1%	2.5 - 3.1%	2.5 - 3.1%	2.5 - 3.1%	3.0 - 3.5%
Colours	Natural**	Black***	Natural****	Black	White
E-module (N/mm ²)	2000	2000	2000	2000	1400
Notch impact strength conform DIN 53453 (KJ/m ²)	2-20	2-20	2-20	2-20	3-25
UV resistant		✓		✓	
Flame retardant					✓
Heat resistant			✓	✓	
Enhanced weatherability				✓	
Flexible at low temperatures					
Radiation resistant					
Chemically resistant					See table 2 (pages 152 - 154)
Halogen free	✓	✓	✓	✓	✓
Silicon free	✓	✓	✓	✓	✓

* 2% carbon for military specifications

** Ty-Fast® ties in standard Polyamide 6.6 are available in natural colour and in a wide range of colours
Ty-Rap® ties in standard Polyamide 6.6 are available in natural colour only

*** Ty-Fast® ties in weather resistant Polyamide 6.6 are available in black colour only (with 2 % carbon for military specifications)

Ty-Rap® ties in weather resistant Polyamide 6.6 are available in black colour (with 2 % carbon for military specifications) and in a wide range of colours (except natural)

**** Heat stabilised Polyamide 6.6 may have a greenish tint

Material codes used in tables

Material	Code
STANDARD POLYAMIDE 6.6	PA6.6
WEATHER RESISTANT POLYAMIDE 6.6	UV PA6.6
HEAT-STABILISED POLYAMIDE 6.6	HS PA6.6
HEAT-STABILISED UV RESISTANT POLYAMIDE 6.6	HSUV PA6.6
FLAME RETARDANT POLYAMIDE 6.6	FR PA6.6
HIGH TEMPERATURE POLYAMIDE 4.6	HT PA4.6
DETECTABLE POLYAMIDE 6.6	DET PA6.6
WEATHER RESISTANT POLYAMIDE 12	UV PA12
POLYPROPYLENE	PP
WEATHER RESISTANT POLYPROPYLENE	UV PP
DETECTABLE POLYPROPYLENE	DET PP
ETFE FLUOROPOLYMER	TZ
ECTFE FLUOROPOLYMER	HAL
TOUGHENED WEATHERABLE ACETAL	DEL
STAINLESS STEEL	SS

Polyamide 4.6 high temperature	Detectable Polyamide 6.6	Polyamide 12 weather resistant	Polypropylene weather resistant	Detectable Polypropylene	ETFE	ECTFE	Toughened weatherable acetal	Stainless Steel
HT PA4.6	DET PA6.6	UV PA12	UV PP	DET PP	TZ	HAL	DEL	SS
TYHT...M	TY...M-NDT	TYC...MX	TYP...MX	TY...M-PDT	TYZ...M	TYV...M	TYD... CSS	YRL.. or YLD... or YLS... or YID... or YBR... or TYS...
+170°C	+85°C	+85°C	+85°C	+85°C	+170°C	+160°C	+85°C	+300°C +150°C for Polyester
-40°C	-40°C	-40°C	-40°C	-40°C	-60°C	-60°C	-40°C	-80°C
V-2	V-2	V-2	HB	HB	V-0	V-0	HB	Excellent
1.18		1.02	0.90 - 0.91		1.67 - 1.75			7.95
1.3%		0.7 - 1.1%	0.01 - 0.03%		0.02%			0%
Light green	Bright blue	Black	Black	Bright blue	Aquamarine	Maroon	Black	Metallic / Black
3200		1600	1100-1300		1000			193000
		3.5-13	3-17		o.B.			122J(IZOD)
		✓	✓	✓	✓	✓	✓	✓
					✓	✓		✓
✓				✓	✓	✓		✓
		✓	✓	✓	✓	✓	✓	✓
		✓	✓	✓	✓			✓
		✓	✓	✓	✓			✓
✓	✓	✓	✓	✓	✓		✓	✓
✓	✓	✓	✓	✓	✓	✓	✓	✓

Material specifications

Material selection and specifications

Table 2 - Resistance of available materials to various chemicals at 21°C

Reagents	Concentration	HS PA6.6	HAL	DEL	PA6.6	UV PA6.6	FR PA6.6	UV PA12	PP	UVPP	TZ	SS
Arsenic Acid	40%	-	-	-	-	-	-	-	E	E	-	E
Acetaldehyde	50%	S	-	-	S	S	S	-	-	-	-	-
Acetone	100%	E	E	F	E	E	E	E	E	E	E	E
Aluminum Hydroxide	AQ	-	E	-	-	-	-	-	E	E	E	E
Ammonia	All	-	E	-	-	-	-	E	E	E	E	15.0
Ammonium Carbonate	5%	S	E	-	S	S	S	E	E	E	E	E
Ammonium Hydroxide	10%	E	E	F	E	E	E	-	E	E	E	E
Ammonium Nitrate	-	-	E	-	-	-	-	E	E	E	E	E
Ammonium Sulfate	10%	-	E	-	-	-	-	S	S	S	S	S
Barium Carbonate	All	-	E	-	-	-	-	E	E	E	E	E
Barium Chloride	5%	NR	-	-	NR	NR	NR	E	E	E	E	E
Barium Sulfate	10%	E	-	-	E	E	E	E	E	E	E	E
Barium Sulfide	10%	S	-	-	S	S	S	E	E	E	E	E
Benzene	100%	E	E	F	E	E	E	E	S	S	E	E
Benzoic Acid	100%	NR	E	-	NR	NR	NR	E	E	E	E	E
Butyric Acid	50%	NR	E	-	NR	NR	NR	-	E	E	E	E
Calcium Carbonate	AQ	-	E	-	-	-	-	-	E	E	E	E
Calcium Hydroxide	20%	-	F	E	-	-	-	-	E	E	E	E
Calcium Hydrochlorite	2	NR	-	-	NR	NR	NR	-	F	F	F	F
Calcium Sulfate	2%	-	E	-	-	-	-	-	E	E	E	E
Carbon Tetrachloride	100%	E	E	E	E	E	E	E	F	F	E	E
Chlorine (WET)	-	NR	-	-	NR	NR	NR	-	F	F	F	F
Chlorine (DRY)	-	NR	-	-	NR	NR	NR	-	NR	NR	F	F
Chloroacetic Acid	30%	NR	-	-	NR	NR	NR	-	-	-	F	F
Chloroform	100%	-	E	-	-	-	-	F	F	F	E	E
Chromic Acid	50%	NR	S	-	NR	NR	NR	-	F	F	F	F
Citric Acid	50%	S	E	E	S	S	S	E	E	E	E	E
Copper Cyanide	10%	-	E	-	-	-	-	-	E	E	E	E
Copper Nitrate	50%	-	E	-	-	-	-	-	E	E	E	E
Cider	-	-	E	-	-	-	-	-	E	E	E	E
Dichloroethane	100%	-	E	-	-	-	-	-	-	-	E	E
Diethyl Ether	100%	-	E	S	-	-	-	E	E	E	E	E
Ethyl Alcohol	100%	S	E	-	S	S	S	E	E	E	E	E
Ethyl Chloride	100%	-	S	E	-	-	-	F	F	F	E	E
Ethylene Glycol	100%	E	E	S	E	E	E	-	E	E	E	E
Ferric Hydroxide	All	-	E	-	-	-	-	-	E	E	E	E
Ferric Nitrate	10%	-	E	-	-	-	-	-	E	E	E	E
Ferrous Sulfate	10%	-	E	-	-	-	-	-	E	E	E	E
Fuel Oil	100%	-	E	-	-	-	-	E	-	-	E	E

Ratings
 E = Excellent
 S = Satisfactory
 F = Fair
 NR = Not Recommended
 (AQ = Aqueous)

Material specifications

Material selection and specifications

Table 2 - Resistance of available materials to various chemicals at 21°C

Reagents	Concentration	HS PA6.6	HAL	DEL	PA6.6	UV PA6.6	FR PA6.6	UV PA12	PP	UVPP	TZ	SS
Furfural	100%	-	E	-	-	-	-	-	F	F	E	E
Gallic Acid	AQ	-	E	-	-	-	-	-	-	-	E	E
Gasoline	100%	E	E	-	E	E	E	-	S	S	E	E
Glycerine	100%	-	E	-	-	-	-	E	E	E	-	E
Hydrocyanic Acid	All	-	E	-	-	-	-	-	E	E	E	E
Hydrogen Peroxide	30%	NR	E	F	NR	NR	NR	S	E	E	E	E
Hydrogen Sulfide	Dry	NR	E	-	NR	NR	NR	E	E	E	E	E
Iodoform	100%	-	E	-	-	-	-	-	-	-	E	E
Isopropyl Alcohol	100%	S	E	-	S	S	S	E	E	E	E	E
Jet Fuel	100%	E	E	-	E	E	E	-	S	S	E	E
Lactic Acid	10%	E	E	-	E	E	E	S	E	E	E	E
Lanolin	10%	E	E	-	E	E	E	E	E	E	E	E
Lead Acetate	5%	-	E	-	-	-	-	-	E	E	E	E
Linseed Oil	10%	E	E	E	E	E	E	E	E	E	E	E
Magnesium Carbonate	All	-	E	-	-	-	-	E	E	E	E	E
Magnesium Chloride	10%	F	-	-	F	F	F	F	F	F	F	F
Magnesium Nitrate	All	-	E	-	-	-	-	E	E	E	E	E
Malic Acid	AQ	-	E	-	-	-	-	-	E	E	E	E
Mercury	100%	-	E	-	-	-	-	E	E	E	E	E
Methyl Alcohol	100%	S	E	-	S	S	S	E	E	E	E	E
Methyl Chloride	100%	-	S	-	-	-	-	-	S	S	E	E
MethylEthyl Ketone	100%	-	E	F	-	-	-	E	E	E	E	E
Naptha	100%	-	E	-	-	-	-	-	E	E	E	E
Nitric Acid	30%	NR	E	NR	NR	NR	NR	-	E	E	E	E
Nitric Acid	30-70%	NR	S	NR	NR	NR	NR	-	F	F	S	E
Nitrous Acid	5%	-	E	-	-	-	-	-	F	F	E	E
Oleic Acid	100%	-	E	S	-	-	-	-	E	E	E	E
Oxalic Acid	10%	-	E	-	-	-	-	S	E	E	E	E
Paraffin	100%	E	E	-	E	E	E	E	E	E	E	E
PetroleumEther	100%	-	E	-	-	-	-	E	F	F	E	E
Phenol	90%	NR	E	NR	NR	NR	NR	-	E	E	E	E
Phosphoric Acid	10%	NR	E	-	NR	NR	NR	-	E	E	E	E
Picric Acid	1%	-	E	-	-	-	-	-	E	E	E	E
Potassium Bromide	AQ	-	-	-	-	-	-	-	S	S	S	S
Potassium Carbonate	1%	-	E	-	-	-	-	E	E	E	E	E
Potassium Chlorate	AQ	-	E	-	-	-	-	S	E	E	E	E
Potassium Dichromate	40%	NR	E	-	NR	NR	NR	F	E	E	E	E
Potassium Ferrocyanide	25%	-	E	-	-	-	-	-	E	E	E	E
Potassium Hydroxide	5%	S	E	-	S	S	S	-	E	E	E	E

Ratings
 E = Excellent
 S = Satisfactory
 F = Fair
 NR = Not Recommended
 (AQ = Aqueous)

Material specifications

Material selection and specifications

Table 2 - Resistance of available materials to various chemicals at 21°C

Reagents	Concentration	HS PA6.6	HAL	DEL	PA6.6	UV PA6.6	FR PA6.6	UV PA12	PP	UVPP	TZ	SS
Potassium Iodide	All	-	E	-	-	-	-	E	E	E	E	E
Potassium Nitrate	50%	F	E	-	F	F	F	E	E	E	E	E
Potassium Permanganate	5%	NR	E	S	NR	NR	NR	NR	E	E	E	E
Potassium Sulfate	5%	-	E	-	-	-	-	E	E	E	E	E
Potassium Sulfide	AQ	-	E	-	-	-	-	-	E	E	E	E
Propyl Alcohol	100%	E	E	-	E	E	E	-	E	E	E	E
Silver Nitrate	10%	-	E	-	-	-	-	E	E	E	E	E
Sodium Acetate	60%	E	E	-	E	E	E	-	E	E	E	E
Sodium Bicarbonate	All	E	E	-	E	E	E	E	E	E	E	E
Sodium Bisulfate	10%	-	E	E	-	-	-	E	E	E	E	E
Sodium Borate	All	-	E	-	-	-	-	-	E	E	E	E
Sodium Carbonate	5%	E	E	S	E	E	E	E	E	E	E	E
Sodium Chlorate	25%	-	E	E	-	-	-	S	E	E	E	E
Sodium Chloride	2%	E	E	S	E	E	E	E	E	E	E	E
Sodium Fluoride	5%	-	-	-	-	-	-	-	F	F	F	F
Sodium Hydroxide	10%	E	E	S	E	E	E	E	E	E	E	E
Sodium Hyposulfite	AQ	-	E	-	-	-	-	-	-	-	E	E
Sodium Nitrate	5%	E	E	-	E	E	E	E	E	E	E	E
Sodium Nitrite	AQ	-	E	-	-	-	-	S	E	E	E	E
Sodium Perchlorate	10%	-	E	-	-	-	-	-	-	-	E	E
Sodium Phosphate	5%	-	E	-	-	-	-	E	E	E	E	E
Sodium Sulfate	5%	S	E	-	S	E	E	E	E	E	E	E
Sodium Thiosulfate	5%	-	-	S	-	-	-	S	S	S	S	S
Stearic Acid	100%	-	E	-	-	-	-	F	E	E	E	E
Sulfur	100%	-	E	-	-	-	-	E	E	E	E	E
Sulfur Dioxide	All	NR	E	-	NR	NR	NR	E	E	E	E	E
Sulfuric Acid	Conc.	NR	E	NR	NR	NR	NR	-	S	S	E	E
Sulfuric Acid	5%	NR	F	F	NR	NR	NR	F	F	F	F	F
Tannic Acid	10%	-	E	-	-	-	-	-	E	E	E	E
Tartaric Acid	50%	-	E	E	-	-	-	E	E	E	E	E
Tetrahydrofuran	100%	-	F	E	-	-	-	S	F	F	E	E
Toluene	100%	E	E	F	E	E	E	E	F	F	E	F
Xylene	100%	E	-	E	E	E	E	F	F	E	E	E
Zinc Chloride	70%	F	E	NR	F	F	F	E	E	E	E	E
Zinc Nitrate	AQ	-	E	-	-	-	-	E	E	E	E	E
Zinc Sulfate	AQ	-	E	-	-	-	-	E	E	E	E	E

Ratings
 E = Excellent
 S = Satisfactory
 F = Fair
 NR = Not Recommended
 (AQ = Aqueous)

Material specifications

Unit conversion factors

Unit	x	Constant	=	unit
BTU		778.0		foot-pound (ft x lb)
BTU		1054.8		Joules
BTU		0.293		Watt-hours (W x h)
centimetres (cm)		0.032808		feet (ft)
centimetres (cm)		0.3937		inches (in)
centimetres (cm)		0.00001		kilometres (km)
centimetres (cm)		0.010		metres (m)
centimetres (cm)		10.0		millimetres (mm)
circular mils		0.00064516		circular millimetres
circular mils		0.0000007854		inches ² (in ²)
circular mils		0.000506671		square millimetres (mm ²)
circular mils		0.7854		mils ²
cubic centimetre (cm ³)		0.000035314		cubic foot (ft ³)
cubic centimetre (cm ³)		0.061023		cubic inch (in ³)
cubic centimetre (cm ³)		0.000001		cubic metre (m ³)
cubic centimetre (cm ³)		0.0026417		gallons
cubic foot (ft ³)		17280.		cubic inch (in ³)
cubic foot (ft ³)		28317.016		cubic centimetre (cm ³)
cubic inch (in ³)		0.00057870		cubic feet (ft ³)
cubic inch (in ³)		0.000016387		cubic metre (m ³)
cubic inch (in ³)		16.387162		cubic centimetre (cm ³)
cubic metre (m ³)		1000000.0		centimetre (cm)
cubic metre (m ³)		35.314456		cubic foot (ft ³)
cubic metre (m ³)		264.17		gallons
foot (ft)		0.00018939		miles
foot (ft)		0.33333		yards (yd)
foot (ft)		12		inches (in)
foot (ft)		0.00030480		kilometres (km)
foot (ft)		0.30480		metres (m)
foot (ft)		30.480		centimetres (cm)
foot (ft)		304.80		millimetres (mm)
foot/pound (ft/lb)		0.00067197		metres/grams (m/g)
foot-pound (ft x lb)		0.001285		BTU
foot-pound (ft x lb)		1.356		Joules (J)
foot/pound (ft/lb)		0.1383		kilogram/metre (kg/m)
gallons (US)		3.785332		litres (l)

Unit	x	Constant	=	unit
gallons		0.13368		cubic foot (ft ³)
gallons		231.0		cubic inch (in ³)
gallons		3785.332		cubic centimetres (cm ³)
grams (g)		15.432		grains
gram/centimetre ³ (gm/cm ³)		0.0361275		pounds/in ³ (lb/in ³)
horsepower (hp)		33000.0		ft x lb/min
horsepower (hp)		550.0		ft x lb/sec
horsepower (hp)		745.7		Watts (W)
inch (in)		0.027178		yards (yd)
inch (in)		0.083333		feet (ft)
inch (in)		0.00002540		kilometre (km)
inch (in)		0.025400		metre (m)
inch (in)		2.54000514		centimetre (cm)
inch (in)		25.4000514		millimetre (mm)
inch (in)		1000.0		mils
Joules		0.000948		BTU
Joules		107		ergs
liters (l)		61.0250		cubic inch (in ³)
metres (m)		1.093611		yard (yd)
metres (m)		3.2808333		feet (ft)
metres (m)		39.37		inch (in)
metres (m)		100.0		centimetre (cm)
miles		1760.0		yards (yd)
miles		5280.0		feet (ft)
miles		1.6093		kilometre (km)
millimetres (mm)		0.0032808		feet (ft)
millimetres (mm)		0.03937		inch (in)
millimetres (mm)		0.001		metres (m)
millimetres (mm)		0.01		centimetres (cm)
millimetres (mm)		39.3701		mils
millimetres (mm)		1000.0		microns (µm)
Watts (W)		44.25		ft x lb/minute
Watts (W)		0.737562		ft x lb/sec
Watts (W)		0.001341		horsepower (hp)
Watt-hours (W x h)		3.41266		BTU

Index

Produkt Ref.	GID Ref.	Page	Produkt Ref.	GID Ref.	Page	Produkt Ref.	GID Ref.	Page
696-41562	7TAG009550R0012	34	CPS6B-100	7TCG054800R0097	126	GRNY-187-0-C	7TAG009750R0032	129
696-41563	7TAG009550R0013	34	CPS6B-100-CV0	7TCG054800R0098	127	GRNY-187-9-C	7TAG009750R0033	129
696-41614	7TAG009910R0018	34	CPS6G-100	7TCG054800R0101	126	GRNY-250-0-C	7TAG009750R0034	129
696-41794	7TAA159090R0000	38	CPS6G-100-CV0	7TCG054800R0102	127	GRNY-250-9-C	7TAG009750R0035	129
696-41795	7TAA159090R0001	39	CPS8B-100	7TCG054800R0103	126	HCNY-125-9-M	7TAG009970R0044	115
696-41836	7TAG009530R0003	27	CPS8B-100-CV0	7TCG054800R0104	127	HCNY-250-9-C	7TAG009970R0045	115
CPS05W-150-EU	7TCG054800R0001	124	CPS8G-100	7TCG054800R0107	126	HCNY-250-9-M	7TAG009970R0046	115
CPS05W-150-FR-EU		125	CPS8G-100-CV0	7TCG054800R0111	127	HCNY-375-9-C	7TAG054980R0536	115
CPS08W-100-EU	7TCG054800R0005	124	CSS-100	7TAA159110R0000	37	HCNY-375-9-M	7TAG009970R0047	115
CPS08W-100-FR-EU		125	CSS-10K	7TAA159130R0001	39	HCNY-500-9-C	7TAG054980R0538	115
CPS10B-100	7TCG054800R0008	126	CSS-160	7TAA159170R0000	37	HCNY-500-9-M	7TAG009970R0048	115
CPS10B-50-CV0	7TCG054800R0010	127	CSS-5K	7TAA159120R0000	39	JTB-500	7TCG054830R0018	48
CPS10G-100	7TCG054800R0012	126	CSS-B	7TAA159220R0000	41	JTB1-500	7TCG054830R0019	48
CPS10G-100-CV0	7TCG054800R0013	127	CSS-H	7TAA159180R0000	41	JTN-500	7TCG054830R0020	48
CPS12B-50	7TCG054800R0015	126	CT-3401	7TCG009750R0009	62	L-10-50R-0-C	7TAG054750R0009	54
CPS12B-50-CV0	7TCG054800R0016	127	CT-5359	7TCG009750R0010	63	L-10-50R-9-C	7TAG054750R0011	54
CPS12G-50	7TCG054800R0018	126	CT1-TB	7TCA131140R0004	135, 140	L-11-50MH-0-C	7TAG054670R0001	52
CPS12G-50-CV0	7TCG054800R0112	127	CT2-TB	7TCA131140R0005	135, 140	L-11-50MH-9-C	7TAG054670R0003	52
CPS13W-50-EU	7TCG054800R0020	124	CT3	7TCA131990R0206	135, 141	L-14-120MH-0-C	7TAG054670R0004	52
CPS13W-50-FR-EU		125	CT4-TB	7TCA131140R0007	135, 141	L-14-120MH-9-C	7TAG054670R0005	52
CPS15B-50	7TCG054800R0025	126	CT5	7TCA131140R0008	135, 142	L-14-50MH-0-C	7TAG054680R0012	52
CPS15B-50-CV0	7TCG054800R0026	127	CT6	7TCA131990R0211	135, 142	L-14-50MH-9-C	7TAG054670R0006	52
CPS15G-50	7TCG054800R0028	126	CT7	7TCA131140R0009	135, 143	L-4-18ID-9-C	7TAG054640R0001	55
CPS15G-50-CV0	7TCG054800R0029	127	CT8	7TCA131140R0010	135, 143	L-4-18ID-9-M	7TAG054640R0002	52
CPS19W-25-EU	7TCG054800R0031	124	CTP-9-180-0-C	7TCG009910R0048	61	L-5-30MH-0-C	7TAG054680R0014	53
CPS19W-25-FR-EU		125	CTP-9-260-0-C	7TCG009910R0049	61	L-5-30MH-9-C	7TAG054670R0008	53
CPS20B-25	7TCG054800R0035	126	CTP-9-360-0-C	7TCG009910R0050	61	L-5-50PM-0-C	7TAG054980R0640	53
CPS20B-50-CV0	7TCG054800R0036	127	CTP-9-500-0-C	7TCG009910R0051	61	L-5-50PM-9-D	7TAG054710R0001	53
CPS20G-25	7TCG054800R0038	126	CTP-9-750-0-C	7TCG009910R0052	61	L-5-50PMR-0-C	7TAG054710R0002	54
CPS20G-50-CV0	7TCG054800R0039	127	ERG120	7TAA131790R0000	134, 136	L-5-50PMR-9-C	7TAG054980R0642	54
CPS25B-25	7TCG054800R0042	126	ERG50	7TAA131790R0001	134, 136	L-5-50R-0-C	7TAG054710R0012	54
CPS25B-50-CV0	7TCG054800R0043	127	ERG50P	7TAA131790R0002	134, 136	L-500-EU	7TCA131140R0022	52
CPS25G-25	7TCG054800R0045	126	FANY-812-9-C	7TAG009970R0025	119	L-7-50ID-9-C	7TAG054640R0003	52
CPS25G-50-CV0	7TCG054800R0046	127	FANY-812-9-D	7TAG009970R0026	119	L-7-50ID-9-M	7TAG054640R0004	52
CPS25W-25-EU	7TCG054800R0048	124	FCC-1	7TCG009630R0012	117	L-7-50MH-0-C	7TAG054670R0009	53
CPS25W-25-FR-EU		125	FCC-1A	7TCG009630R0013	117	L-7-50MH-9-C	7TAG054660R0000	53
CPS29W-15-EU	7TCG054800R0051	124	FCC-2	7TCG009630R0014	117	L-7-50PM-0-C	7TAG054710R0004	53
CPS29W-25-FR-EU		125	FCC-2A	7TCG009630R0015	117	L-7-50PM-9-C	7TAG054710R0005	54
CPS30B-25	7TCG054800R0058	126	FCC-3	7TCG009630R0016	117	L-7-50PMR-9-C	7TAG054980R0648	54
CPS30B-50-CV0	7TCG054800R0059	127	FCC-3A	7TCG009630R0017	117	L-8-50R-0-C	7TAG054750R0016	54
CPS30G-25	7TCG054800R0061	126	FO200-40-0	7TAG009630R0018	58	L-8-50R-9-C	7TAG054750R0018	54
CPS30G-50-CV0	7TCG054800R0062	127	FO200-50-0	7TAG009630R0026	58	L300-FR	7TCA131810R0001	134, 138
CPS32W-15-EU	7TCG054800R0064	124	FO350-40-0	7TAG009630R0031	58	L-600	7TCA131990R0273	134, 141
CPS32W-15-FR-EU		125	FO350-50-0	7TAG009630R0033	58	MCNY-1250-0-C	7TAG009990R0006	94
CPS38W-15-EU	7TCG054800R0068	124	FO350-50-0-FR	7TAG009900R0104	58	MCNY-1250-9-C	7TAG009990R0007	94
CPS38W-15-FR-EU		125	FOL300-50-0	7TAG009630R0036	58	MCNY-1250-9-D	7TAG009990R0008	94
CPS3B-100	7TCG054800R0071	126	FOL500-50-0	7TAG009630R0040	58	MCNY-1250-9-L	7TAG009990R0009	94
CPS3B-100-CV0	7TCG054800R0072	127	FOR180-50-0	7TAG009630R0041	59	N4NY-002-0-M	7TAG009970R0050	110
CPS3G-100	7TCG054800R0075	126	FOR180-50-0-FR	7TAG009370R0000	59	N4NY-003-0-M	7TAG009970R0056	110
CPS3G-100-CV0	7TCG054800R0108	127	FOS150-50-0	7TAG009630R0046	59	N4NY-004-0-M	7TAG009970R0063	110
CPS40B-25	7TCG054800R0076	126	FOS320-50-0	7TAG009630R0048	59	N4NY-005-0-M	7TAG009970R0070	110
CPS40B-50-CV0	7TCG054800R0077	127	FOS500-50-0	7TAG009630R0050	59	N4NY-006-0-M	7TAG009970R0075	110
CPS40G-25	7TCG054800R0079	126	FRPV-1000-8-C	7TAG009970R0028	118	N4NY-008-0-M	7TAG009970R0089	110
CPS40G-50-CV0	7TCG054800R0080	127	FRPV-1000-8-D	7TAG009970R0029	118	N6NY-009-0-M	7TAG009970R0110	110
CPS4B-100	7TCG054800R0081	126	FSNY-812-9-C	7TAG009970R0030	119	N6NY-010-0-M	7TAG009970R0113	110
CPS4B-100-CV0	7TCG054800R0082	127	GRNY-040-0-C	7TAG009750R0017	129	N6NY-011-0-M	7TAG009970R0116	110
CPS4G-100	7TCG054800R0084	126	GRNY-040-9-C	7TAG009750R0018	129	N6NY-012-0-M	7TAG009970R0119	110
CPS4G-100-CV0	7TCG054800R0085	127	GRNY-052-0-C	7TAG009750R0019	129	N6NY-013-0-M	7TAG009970R0122	110
CPS50B-25	7TCG054800R0086	126	GRNY-052-9-C	7TAG009750R0021	129	N6NY-014-0-M	7TAG009970R0125	110
CPS50B-50-CV0	7TCG054800R0087	127	GRNY-062-0-C	7TAG009750R0022	129	N6NY-016-0-M	7TAG009970R0129	110
CPS50G-25	7TCG054800R0089	126	GRNY-062-9-C	7TAG009750R0023	129	N6NY-004C-0-M	7TAG009970R0096	110
CPS50G-50-CV0	7TCG054800R0110	127	GRNY-085-0-C	7TAG009750R0024	129	N6NY-005C-0-M	7TAG009970R0099	110
CPS50W-15-FR-EU		125	GRNY-085-9-C	7TAG009750R0026	129	N6NY-006C-0-M	7TAG009970R0102	110
CPS5B-100	7TCG054800R0092	126	GRNY-100-0-C	7TAG009750R0027	129	N6NY-008C-0-M	7TAG009970R0107	110
CPS5B-100-CV0	7TCG054800R0093	127	GRNY-100-9-C	7TAG009750R0028	129	PCNY-125-9-D	7TAG009970R0143	115
CPS5G-100	7TCG054800R0096	126	GRNY-125-0-C	7TAG009750R0029	129	PCNY-250-9-C	7TAG009970R0144	115
CPS5G-100-CV0	7TCG054800R0109	127	GRNY-125-9-C	7TAG009750R0031	129	PCNY-250-9-D	7TAG009970R0145	115

Index

Produkt Ref.	GID Ref.	Page	Produkt Ref.	GID Ref.	Page	Produkt Ref.	GID Ref.	Page
PCNY-375-9-C	7TAG009970R0146	115	SKT370-220-100	7TCA300180R0004	64	TC141-NDT	7TAG009660R0010	102
PCNY-375-9-D	7TAG009970R0147	115	SKT370-220X	7TCA300240R0004	65	TC142	7TAG009880R0007	95
PCNY-500-9-D	7TAG009970R0148	115	SKT370-220X-100	7TCA300220R0004	65	TC142-NDT	7TAG009660R0011	102
RANY-160-9-D	7TAG009970R0149	116	SKT370-540	7TCA300280R0001	64	TC142X	7TAG009840R0007	95
RANY-280-0-D	7TAG054980R1267	116	SKT370-540-100	7TCA300260R0001	64	TC150x150	7TAG009840R0008	92
RANY-280-9-D	7TAG009970R0150	116	SKT370-540X	7TCA300320R0001	65	TC150x150A	7TAG009840R0009	92
RANY-530-9-D	7TAG009970R0151	116	SKT370-540X-100	7TCA300300R0001	65	TC150x150A-L	7TAG009830R0002	92
RANY-620-9-D	7TAG009970R0152	116	SKT450-540-50	7TCA300260R0003	64	TC150x150AX	7TAG009840R0010	92
SF100-18	7TAG009700R0000	57	SKT450-540X-50	7TCA300300R0003	65	TC150x150AX-L	7TAG009830R0003	92
SF100-18X	7TAG009700R0006	57	SKT750-540-50	7TCA300260R0002	64	TC150x150L	7TAG009820R0004	92
SF175-50	7TAG009700R0012	57	SKT750-540X-50	7TCA300300R0002	65	TC200x200	7TAG009840R0011	92
SF175-50X	7TAG009700R0018	57	SKT776-780-50	7TCA300340R0000	64	TC200x200A	7TAG009840R0012	92
SF300-50	7TAG009700R0026	57	SKT776-780X-50	7TCA300360R0000	65	TC200x200A-L	7TAG009830R0005	92
SF300-50X	7TAG009700R0032	57	SKT912-780-50	7TCA300340R0001	64	TC200x200AX	7TAG009840R0013	92
SKT100-80	7TCA300040R0000	64	SKT912-780X-50	7TCA300360R0001	65	TC200x200L	7TAG009820R0006	92
SKT100-80-100	7TCA300020R0000	64	SMNY-001-0-D	7TAG009990R0018	96	TC2PA	7TAG009910R0083	147
SKT100-80X	7TCA300080R0000	65	SMNY-001-9-D	7TAG009990R0019	96	TC342	7TAG009820R0036	93
SKT100-80X-100	7TCA300060R0000	65	SRPE-10-0	7TCG054090R0216	128	TC342A	7TAG009820R0037	93
SKT140-180	7TCA300120R0000	64	SRPE-10-9	7TCG054090R0217	128	TC342A-NDT	7TAG009660R0012	102
SKT140-180-100	7TCA300100R0000	64	SRPE-12-0	7TCG054090R0220	128	TC342A-X	7TAG009820R0038	93
SKT140-180X	7TCA300160R0000	65	SRPE-12-9	7TCG054090R0221	128	TC342X	7TAG009820R0040	93
SKT140-180X-100	7TCA300140R0000	65	SRPE-15-0	7TCG054090R0222	128	TC344	7TAG009810R0008	91
SKT140-80	7TCA300040R0001	64	SRPE-15-9	7TCG054090R0223	128	TC344A	7TAG009810R0010	91
SKT140-80-100	7TCA300020R0001	64	SRPE-19-0	7TCG054090R0224	128	TC344A-NDT	7TAG009660R0013	102
SKT140-80X	7TCA300080R0001	65	SRPE-19-9	7TCG054090R0225	128	TC344AX	7TAG009810R0012	91
SKT140-80X-100	7TCA300060R0001	65	SRPE-24-0	7TCG054090R0226	128	TC345	7TAG009820R0041	90
SKT160-80	7TCA300040R0002	64	SRPE-24-9	7TCG054090R0227	128	TC345A	7TAG009820R0045	90
SKT160-80-100	7TCA300020R0002	64	SRPE-6-0	7TCG054090R0232	128	TC345AX	7TAG009820R0048	90
SKT160-80X	7TCA300080R0002	65	SRPE-6-9	7TCG054090R0233	128	TC347	7TAG009820R0050	89
SKT160-80X-100	7TCA300060R0002	65	SRPE-8-0	7TCG054090R0238	128	TC347A	7TAG009820R0051	89
SKT188-220	7TCA300200R0000	64	SRPE-8-9	7TCG054090R0239	128	TC347A-NDT	7TAG009660R0014	102
SKT188-220-100	7TCA300180R0000	64	TB-12-50RLDH	7TCG054360R0057	56	TC347FR	7TAG009820R0053	89
SKT188-220X	7TCA300240R0000	65	TB-15-50RLDH	7TCG054360R0059	56	TC347X	7TAG009820R0054	89
SKT188-220X-100	7TCA300220R0000	65	TB-4-50PMR-9-C-EU	7TCG054360R0060	53	TC349A-TB	7TCG009900R0001	112
SKT200-180	7TCA300120R0001	64	TB-50RLDH	7TCG054360R0061	56	TC349AN	7TCG009500R0035	112
SKT200-180-100	7TCA300100R0001	64	TC050x050A	7TAG009840R0003	92	TC350	7TCG009900R0002	112
SKT200-180X	7TCA300160R0001	65	TC050x050A-C	7TAG009830R0000	92	TC350A-TB	7TCG009900R0003	112
SKT200-180X-100	7TCA300140R0001	65	TC050x050AX	7TAG009840R0004	92	TC350AN	7TCG009500R0036	112
SKT200-80	7TCA300040R0003	64	TC050x050AX-C	7TAG009830R0001	92	TC368	7TAG009840R0015	92
SKT200-80-100	7TCA300020R0003	64	TC101	7TAG009880R0000	104	TC368A	7TAG009840R0016	92
SKT200-80X	7TCA300080R0003	65	TC102	7TAG009880R0001	99	TC375	7TAG009910R0084	104
SKT200-80X-100	7TCA300060R0003	65	TC102-NDT	7TAG009660R0008	102	TC376	7TAG009910R0086	104
SKT215-220	7TCA300200R0001	64	TC102-PDT	7TAG009660R0009	102	TC502	7TAG009870R0000	99
SKT215-220-100	7TCA300180R0001	64	TC103	7TAG009880R0002	104	TC5102-NDT	7TAG009660R0015	102
SKT215-220X	7TCA300240R0001	65	TC104	7TAG009880R0003	99	TC5105	7TAG009680R0006	109
SKT215-220X-100	7TCA300220R0001	65	TC105	7TAG009840R0005	109	TC5140	7TAG009840R0017	95
SKT250-220	7TCA300200R0002	64	TC105AP	7TCG009500R0034	109	TC5141	7TAG009870R0002	95
SKT250-220-100	7TCA300180R0002	64	TC106	7TAG009910R0071	103	TC5141-NDT	7TAG009660R0017	102
SKT250-220X	7TCA300240R0002	65	TC109	7TAG009920R0001	103	TC5141-PDT	7TAG009660R0018	102
SKT250-220X-100	7TCA300220R0002	65	TC1101	7TAG009910R0072	104	TC5142	7TAG009870R0003	95
SKT300-180	7TCA300120R0002	64	TC1102	7TAG009910R0073	104	TC5142-NDT	7TAG009660R0019	102
SKT300-180-100	7TCA300100R0002	64	TC1103	7TAG009910R0074	104	TC5142-PDT	7TAG009660R0020	102
SKT300-180X	7TCA300160R0002	65	TC1104	7TAG009910R0075	104	TC5142X	7TAG009810R0018	95
SKT300-180X-100	7TCA300140R0002	65	TC1105	7TAG009910R0076	104	TC5342A	7TAG009800R0000	93
SKT300-220	7TCA300200R0003	64	TC1112	7TAG009910R0077	104	TC5342A-NDT	7TAG009660R0021	102
SKT300-220-100	7TCA300180R0003	64	TC1113	7TAG009910R0078	104	TC5342A-PDT	7TAG009660R0022	102
SKT300-220X	7TCA300240R0003	65	TC1114	7TAG009910R0079	104	TC5344	7TAG009790R0010	91
SKT300-220X-100	7TCA300220R0003	65	TC1115	7TAG009910R0080	104	TC5344A-NDT	7TAG009660R0023	102
SKT300-540	7TCA300280R0000	64	TC1116	7TAG009910R0081	104	TC5344A-PDT	7TAG009660R0024	102
SKT300-540-100	7TCA300260R0000	64	TC1117	7TAG009910R0082	104	TC5344AR	7TCG009500R0039	91
SKT300-540X	7TCA300320R0000	65	TC112-TB	7TAG009880R0004	98	TC5344AX	7TCG009790R0012	91
SKT300-540X-100	7TCA300300R0000	65	TC116-TB	7TAG009860R0003	108	TC5345A	7TAG009800R0002	90
SKT370-180	7TCA300120R0003	64	TC118-TB	7TAG009860R0004	108	TC5345AX	7TAG009800R0005	90
SKT370-180-100	7TCA300100R0003	64	TC120	7TAG009860R0005	108	TC5347A-NDT	7TAG009660R0025	102
SKT370-180X	7TCA300160R0003	65	TC121-TB	7TAG009860R0006	106	TC5347A-PDT	7TAG009660R0026	102
SKT370-180X-100	7TCA300140R0003	65	TC140	7TAG009880R0005	95	TC5347AR	7TCG009500R0040	89
SKT370-220	7TCA300200R0004	64	TC141	7TAG009880R0006	95	TC5347AX	7TCG009800R0008	89

Index

Produkt Ref.	GID Ref.	Page	Produkt Ref.	GID Ref.	Page	Produkt Ref.	GID Ref.	Page
TC5349A-TB	7TCG009890R0001	112	TY125-18-8		47	TY200-120-8		47
TC5350	7TCG009500R0042	112	TY125-18-9		47	TY200-120-9		47
TC5350A-TB	7TCG009890R0002	112	TY125-30	7TAG054360R0119	47	TY200-40	7TAG054360R0213	47
TC5355	7TAG009870R0004	105	TY125-30X	7TAG054360R0121	47	TY200-40X	7TAG054360R0228	47
TC5356	7TAG009870R0005	105	TY125-30-1		47	TY200-40-1		47
TC5357	7TAG009870R0006	105	TY125-30-2		47	TY200-40-2	7TAG054360R0216	47
TC5358	7TAG009850R0001	105	TY125-30-3		47	TY200-40-3	7TAG054360R0218	47
TC5359	7TAG009850R0002	105	TY125-30-4		47	TY200-40-4		47
TC5823	7TAG009850R0003	107	TY125-30-5		47	TY200-40-5		47
TC5828	7TAG009870R0007	101	TY125-30-6		47	TY200-40-6	7TAG054360R0222	47
TC804-TB	7TAG009880R0008	99	TY125-30-7		47	TY200-40-7	7TAG054360R0224	47
TC812-TB	7TAG009880R0009	98	TY125-30-8		47	TY200-40-8		47
TC814-TB	7TAG009880R0011	98	TY125-30-9		47	TY200-40-9		47
TC815-TB	7TAG009880R0012	100	TY125-40	7TAG054360R0123	47	TY225-50	7TCG054360R0230	47
TC817-TB	7TAG009840R0020	93	TY125-40X	7TAG054360R0141	47	TY225-50X	7TCG054360R0236	47
TC823-TB	7TAG009860R0007	107	TY125-40-1	7TAG054360R0124	47	TY225-50-1		47
TC823X	7TAG009860R0008	107	TY125-40-2	7TAG054360R0127	47	TY225-50-2		47
TC824-TB	7TAG009840R0021	109	TY125-40-3		47	TY225-50-3		47
TC826-TB	7TAG009880R0014	103	TY125-40-4	7TAG054360R0132	47	TY225-50-4		47
TC828-TB	7TAG009880R0015	101	TY125-40-5	7TAG054360R0134	47	TY225-50-5		47
TC86	7TAG009710R0006	114	TY125-40-6	7TAG054360R0136	47	TY225-50-6		47
TC87	7TAG009710R0007	114	TY125-40-7		47	TY225-50-7		47
TC88	7TAG009710R0008	113	TY125-40-8		47	TY225-50-8		47
TC92	7TAG009910R0088	97	TY125-40-9		47	TY225-50-9		47
TC95	7TAG009710R0009	113	TY125-50	7TAG054360R0144	47	TY232M	7TAG009040R0005	9
TCP360	7TAA159160R0000	40	TY125-50X	7TAG054360R0146	47	TY232M-1	7TAG009070R0083	11
TCP5255	7TAA159090R0004	40	TY125-50-1		47	TY232M-2	7TAG009070R0084	11
TCS25	7TAG009470R0057	82	TY125-50-2		47	TY232M-3	7TAG009070R0085	11
TCZ347	7TAG009820R0055	89	TY125-50-3		47	TY232M-4	7TAG009070R0086	11
TS1025HF	7TCG054360R0062	51	TY125-50-4		47	TY232M-5	7TAG009070R0087	11
TS1435HF	7TCG054360R0063	51	TY125-50-5		47	TY232M-6	7TAG009070R0088	11
TS2045HF	7TCG054360R0064	51	TY125-50-6		47	TY232M-7	7TAG009070R0089	11
TS2845HF	7TCG054360R0065	51	TY125-50-7		47	TY232M-8	7TAG009070R0090	11
TS3645HF	7TCG054360R0066	51	TY125-50-8		47	TY232M-9	7TAG009070R0091	11
TS3675HF	7TCG054360R0067	51	TY125-50-9		47	TY232MFR	7TAG009570R0000	17
TT-11-30-0-L-EU	7TAG054780R0009	60	TY1435M	7TAG009520R0045	26	TY232MX	7TAG009040R0007	10
TT-11-30-9-L-EU	7TAG054780R0012	60	TY150-18	7TAG054360R0149	47	TY234M	7TAG009050R0000	9
TT-14-30-0-L-EU	7TAG054780R0015	60	TY150-18X	7TAG054360R0151	47	TY234M-1		11
TT-14-30-9-L-EU	7TAG054780R0017	60	TY150-18-1		47	TY234M-2	7TAG009070R0092	11
TT-7-30-0-L-EU	7TAG054780R0020	60	TY150-18-2		47	TY234M-3		11
TT-7-30-9-L-EU	7TAG054780R0023	60	TY150-18-3		47	TY234M-4	7TAG009070R0093	11
Ty-Tote-23	7TAG009930R0011	16	TY150-18-4		47	TY234M-5		11
Ty-Tote-25	7TAG009930R0012	16	TY150-18-5		47	TY234M-6	7TAG009000R0210	11
TY100-18	7TCG054360R0073	47	TY150-18-6		47	TY234M-7	7TAG009070R0094	11
TY100-18X	7TCG054360R0096	47	TY150-18-7		47	TY234M-8	7TAG009000R0212	11
TY100-18-1	7TCG054360R0074	47	TY150-18-8		47	TY234M-9	7TAG009000R0211	11
TY100-18-2	7TCG054360R0078	47	TY150-18-9		47	TY234MX	7TAG009050R0001	10
TY100-18-3	7TCG054360R0081	47	TY175-50	7TAG054360R0153	47	TY23M	7TAG009040R0009	9
TY100-18-4	7TCG054360R0085	47	TY175-50X	7TAG054360R0178	47	TY23M-6	7TAG009070R0100	11
TY100-18-5	7TCG054360R0087	47	TY175-50-1	7TAG054360R0155	47	TY23M-7	7TAG009070R0101	11
TY100-18-6	7TCG054360R0089	47	TY175-50-2	7TAG054360R0159	47	TY23M-8	7TAG009070R0102	11
TY100-18-7	7TCG054360R0091	47	TY175-50-3	7TAG054360R0163	47	TY23M-9	7TAG009070R0103	11
TY100-18-8	7TCG054360R0093	47	TY175-50-4	7TAG054360R0167	47	TY23MFR	7TAG009570R0002	17
TY100-18-9		47	TY175-50-5	7TAG054360R0169	47	TY23MX	7TAG009040R0011	10
TY1000-175	7TAG054360R0100	49	TY175-50-6	7TAG054360R0171	47	TY23MX-A	7TAG009640R0000	19
TY1000-175X	7TAG054360R0101	49	TY175-50-7	7TAG054360R0173	47	TY242M	7TAG009120R0000	9
TY1200-175	7TAG054360R0102	49	TY175-50-8	7TAG054360R0175	47	TY242M-1	7TAG009000R0216	11
TY1200-175X	7TAG054360R0103	49	TY175-50-9		47	TY242M-2	7TAG009160R0005	11
TY125-18	7TCG054360R0104	47	TY200-120	7TCG054360R0182	47	TY242M-3	7TAG009160R0006	11
TY125-18X	7TCG054360R0148	47	TY200-120X	7TCG054360R0188	47	TY242M-4	7TAG009160R0007	11
TY125-18-1		47	TY200-120-1		47	TY242M-5	7TAG009160R0008	11
TY125-18-2	7TCG054360R0107	47	TY200-120-2	7TCG054360R0184	47	TY242M-6	7TAG009160R0009	11
TY125-18-3		47	TY200-120-3		47	TY242M-7	7TAG009160R0010	11
TY125-18-4	7TCG054360R0068	47	TY200-120-4		47	TY242M-8	7TAG009160R0011	11
TY125-18-5	7TCG054360R0111	47	TY200-120-5	7TCG054360R0185	47	TY242M-9	7TAG009160R0012	11
TY125-18-6	7TCG054360R0113	47	TY200-120-6	7TCG054360R0187	47	TY242MX	7TAG009130R0004	10
TY125-18-7		47	TY200-120-7		47	TY244M	7TCG009130R0005	9

Index

Produkt Ref.	GID Ref.	Page	Produkt Ref.	GID Ref.	Page	Produkt Ref.	GID Ref.	Page
TY244M-1		11	TY271M-9		11	TY29M-6	7TCG009370R0036	11
TY244M-2	7TCG009160R0013	11	TY271MX	7TCG009450R0163	10	TY29M-7	7TCG009370R0037	11
TY244M-3	7TCG009000R0219	11	TY272M	7TAG009340R0002	9	TY29M-8	7TCG009370R0038	11
TY244M-4	7TCG009000R0220	11	TY272M-1	7TAG009000R0239	11	TY29M-9	7TCG009370R0039	11
TY244M-5		11	TY272M-2	7TAG009370R0001	11	TY29MX	7TAG009330R0014	10
TY244M-6	7TCG009160R0014	11	TY272M-3	7TAG009370R0003	11	TY300-120	7TAG054360R0238	47
TY244M-7		11	TY272M-4	7TAG009370R0004	11	TY300-40	7TCG054360R0240	47
TY244M-8	7TCG009160R0015	11	TY272M-5	7TAG009370R0005	11	TY300-40X	7TCG054360R0256	47
TY244M-9		11	TY272M-6	7TAG009370R0007	11	TY300-40-1		47
TY244MX	7TCG009130R0006	10	TY272M-7	7TAG009370R0009	11	TY300-40-2	7TCG054360R0243	47
TY24M	7TAG009130R0007	9	TY272M-8		11	TY300-40-3		47
TY24M -1	7TAG009160R0016	11	TY272M-9	7TAG009370R0011	11	TY300-40-4	7TCG054360R0250	47
TY24M -2	7TAG009160R0017	11	TY272MFR		17	TY300-40-5	7TCG054360R0252	47
TY24M -3	7TAG009160R0018	11	TY272MX	7TAG009330R0007	10	TY300-40-6	7TCG054360R0254	47
TY24M -4	7TAG009160R0019	11	TY275M	7TAG009330R0009	9	TY300-40-7		47
TY24M -5	7TAG009160R0020	11	TY275M-1	7TAG009000R0241	11	TY300-40-8		47
TY24M -6	7TAG009160R0021	11	TY275M-2	7TAG009370R0014	11	TY300-40-9		47
TY24M -7	7TAG009160R0022	11	TY275M-3	7TAG009370R0015	11	TY300-50	7TAG054360R0259	47
TY24M -8	7TAG009160R0023	11	TY275M-4	7TAG009370R0012	11	TY300-50X	7TAG054360R0278	47
TY24M -9	7TAG009160R0024	11	TY275M-5	7TAG009370R0013	11	TY300-50-1		47
TY24MFR	7TAG009570R0003	17	TY275M-6	7TAG009370R0016	11	TY300-50-2	7TAG054360R0262	47
TY24MX	7TAG009130R0009	10	TY275M-7		11	TY300-50-3		47
TY24MX-A	7TAG009640R0001	19	TY275M-8		11	TY300-50-4	7TAG054360R0269	47
TY253M	7TAG009220R0001	9	TY275M-9	7TAG009000R0242	11	TY300-50-5	7TAG054360R0271	47
TY253M-1	7TAG009270R0002	11	TY275MX	7TAG009320R0001	10	TY300-50-6	7TAG054360R0273	47
TY253M-2	7TAG009270R0003	11	TY277M	7TAG009340R0003	9	TY300-50-7		47
TY253M-3	7TAG009270R0004	11	TY277M-1	7TAG009000R0243	11	TY300-50-8		47
TY253M-4	7TAG009270R0009	11	TY277M-2	7TAG009370R0017	11	TY300-50-9		47
TY253M-5	7TAG009270R0005	11	TY277M-3	7TAG009370R0018	11	TY33M	7TAG009520R0046	26
TY253M-6	7TAG009270R0006	11	TY277M-4	7TAG009370R0019	11	TY33MX	7TAG009520R0048	26
TY253M-7	7TAG009270R0007	11	TY277M-5	7TAG009370R0020	11	TY34M	7TAG009520R0049	26
TY253M-8	7TAG009270R0008	11	TY277M-6	7TAG009370R0021	11	TY34MX	7TAG009520R0050	26
TY253M-9	7TAG009000R0223	11	TY277M-7		11	TY35M	7TAG009520R0053	26
TY253MX	7TAG009220R0003	10	TY277M-8		11	TY35MX	7TAG009520R0056	26
TY25M	7TAG009210R0042	9	TY277M-9	7TAG009180R0005	11	TY37M	7TAG009520R0057	26
TY25M-1	7TAG009270R0010	11	TY277MX	7TAG009330R0010	10	TY37MX	7TAG009520R0060	26
TY25M-2	7TAG009270R0011	11	TY27M	7TAG009320R0003	9	TY38M	7TAG009530R0005	27
TY25M-3	7TAG009270R0013	11	TY27M-1	7TAG009370R0022	11	TY38MX	7TAG009530R0006	27
TY25M-4	7TAG009270R0014	11	TY27M-2	7TAG009370R0023	11	TY400-120	7TAG054360R0282	47
TY25M-5	7TAG009270R0015	11	TY27M-3	7TAG009370R0024	11	TY400-120X	7TAG054360R0307	47
TY25M-6	7TAG009270R0016	11	TY27M-4	7TAG009370R0025	11	TY400-120-1	7TAG054360R0283	47
TY25M-7	7TAG009270R0017	11	TY27M-5	7TAG009370R0026	11	TY400-120-2		47
TY25M-8	7TAG009270R0018	11	TY27M-6	7TAG009370R0027	11	TY400-120-3	7TAG054360R0290	47
TY25M-9	7TAG009270R0019	11	TY27M-7	7TAG009370R0028	11	TY400-120-4	7TAG054360R0293	47
TY25MFR	7TAG009570R0004	17	TY27M-8	7TAG009370R0029	11	TY400-120-5	7TAG054360R0295	47
TY25MX	7TAG009210R0045	10	TY27M-9	7TAG009370R0030	11	TY400-120-6	7TAG054360R0299	47
TY25MX-A	7TAG009640R0002	19	TY27MFR	7TAG009570R0006	17	TY400-120-7	7TAG054360R0301	47
TY26M	7TAG009120R0002	9	TY27MX	7TAG009320R0004	10	TY400-120-8	7TAG054360R0303	47
TY26M-1	7TAG009000R0234	11	TY27MX-A	7TAG009640R0003	19	TY400-120-9		47
TY26M-2	7TAG009160R0025	11	TY28M	7TAG009210R0048	9	TY400-40	7TAG054360R0311	47
TY26M-3	7TAG009160R0026	11	TY28M-1	7TAG009270R0020	11	TY400-40	7TAG054360R0313	47
TY26M-4	7TAG009160R0027	11	TY28M-2	7TAG009270R0021	11	TY400-40		47
TY26M-5	7TAG009160R0028	11	TY28M-3	7TAG009270R0022	11	TY400-40		47
TY26M-6	7TAG009160R0029	11	TY28M-4	7TAG009270R0023	11	TY400-40		47
TY26M-7	7TAG009000R0235	11	TY28M-5	7TAG009270R0024	11	TY400-40		47
TY26M-8	7TAG009160R0030	11	TY28M-6	7TAG009270R0025	11	TY400-40		47
TY26M-9	7TAG009000R0236	11	TY28M-7	7TAG009270R0026	11	TY400-40		47
TY26MX	7TAG009120R0004	10	TY28M-8	7TAG009270R0027	11	TY400-40		47
TY271M	7TCG009450R0162	9	TY28M-9	7TAG009270R0028	11	TY400-40		47
TY271M-1		11	TY28MFR	7TAG009570R0007	17	TY400-40		47
TY271M-2		11	TY28MX	7TAG009210R0050	10	TY400-50	7TAG054360R0315	47
TY271M-3		11	TY29M	7TAG009330R0012	9	TY400-50X		47
TY271M-4		11	TY29M-1	7TCG009370R0031	11	TY400-50-1		47
TY271M-5		11	TY29M-2	7TCG009370R0032	11	TY400-50-2	7TAG054360R0319	47
TY271M-6		11	TY29M-3	7TCG009370R0033	11	TY400-50-3		47
TY271M-7		11	TY29M-4	7TCG009370R0034	11	TY400-50-4		47
TY271M-8		11	TY29M-5	7TCG009370R0035	11	TY400-50-5	7TAG054360R0326	47

Index

Produkt Ref.	GID Ref.	Page	Produkt Ref.	GID Ref.	Page	Produkt Ref.	GID Ref.	Page
TY400-50-6	7TAG054360R0328	47	TY53510M-4	7TCG009000R0301	11	TY800-120-9		47
TY400-50-7		47	TY53510M-5		11	TY900-175	7TAG054360R0350	49
TY400-50-8	7TAG054360R0331	47	TY53510M-6	7TCG009400R0009	11	TY900-175X	7TAG054360R0351	49
TY400-50-9		47	TY53510M-7		11	TYB2315M	7TAG009050R0002	9
TY409	7TAG009550R0018	32	TY53510M-8		11	TYB2315M-1	7TAG009070R0106	9
TY4100PX	7TCG009460R0099	34	TY53510M-9	7TCG009000R0302	11	TYB2315M-2	7TAG009070R0107	9
TY41M	7TAG009520R0061	29	TY53510MX	7TCG009380R0002	10	TYB2315M-3	7TAG009070R0111	9
TY450-120	7TAG054360R0341	47	TY535M	7TAG009520R0068	26	TYB2315M-4	7TAG009070R0108	9
TY46M	7TAG009510R0018	36	TY535MX	7TAG009520R0069	26	TYB2315M-5	7TAG009070R0109	9
TY46MD	7TAG009510R0025	36	TY537M	7TAG009520R0070	26	TYB2315M-6	7TAG009000R0323	9
TY46MF	7TAG009510R0031	36	TY537MX	7TAG009520R0071	26	TYB2315M-8	7TAG009070R0110	9
TY46MT	7TAG009510R0033	36	TY53M	7TAG009510R0052	35	TYB2315M-9	7TAG009000R0324	9
TY48M	7TAG009510R0039	36	TY5409	7TAG009550R0020	32	TYB2315MX	7TAG009050R0003	10
TY512M	7TAG009510R0044	35	TY5418PX	7TAG009550R0021	33	TYB232M	7TCG009020R0054	14
TY51M	7TAG009510R0046	35	TY541M	7TAG009520R0072	29	TYB232M-1		14
TY5232MR	7TCG009030R0080	12	TY542PX	7TAG009550R0022	33	TYB232M-2		14
TY5232MXR	7TCG009030R0082	13	TY5442PX	7TAG009550R0025	33	TYB232M-3		14
TY5234M	7TAG009020R0052	12	TY544MX	7TAG009530R0008	30	TYB232M-4		14
TY5234MX	7TAG009010R0011	13	TY54513M	7TCG009380R0003	9	TYB232M-5		14
TY523M-NDT	7TAG009660R0029	23	TY54513M-1		11	TYB232M-6		14
TY523M-PDT	7TAG009660R0030	23	TY54513M-2	7TCG009380R0004	11	TYB232M-7		14
TY523MR	7TCG009030R0085	12	TY54513M-3		11	TYB232M-8		14
TY523MXR	7TCG009450R0168	13	TY54513M-4		11	TYB232M-9		14
TY5242MR	7TCG009110R0021	12	TY54513M-5		11	TYB232MX	7TCG009020R0055	14
TY5242MXR	7TCG009110R0022	13	TY54513M-6		11	TYB23M	7TCG009450R0186	14
TY5244MR	7TCG009110R0023	12	TY54513M-7		11	TYB23M-1		14
TY5244MXR	7TCG009110R0025	13	TY54513M-8		11	TYB23M-2	7TCG009450R0188	14
TY524M-NDT	7TAG009660R0031	23	TY54513M-9		11	TYB23M-3		14
TY524MR	7TCG009110R0026	12	TY54513MX	7TCG009380R0005	10	TYB23M-4		14
TY524MXR	7TCG009450R0172	13	TY545MX	7TAG009520R0073	30	TYB23M-5		14
TY5253MR	7TAG009200R0017	12	TY5460PX	7TAG009550R0026	33	TYB23M-6		14
TY5253MXR	7TCG009200R0019	13	TY546M	7TAG009510R0058	36	TYB23M-7		14
TY525M-CLRS	7TAG009270R0037	15	TY546MD	7TAG009510R0059	36	TYB23M-8	7TCG009450R0189	14
TY525M-NDT	7TAG009660R0032	23	TY546MF	7TAG009510R0060	36	TYB23M-9		14
TY525M-PDT	7TAG009660R0033	23	TY546MT	7TAG009510R0061	36	TYB23MX	7TCG009960R0068	14
TY525MR	7TCG009200R0021	12	TY548M	7TAG009510R0063	36	TYB24M	7TCG009140R0019	14
TY525MXR	7TCG009200R0023	13	TY54SM	7TCG009460R0104	27	TYB24M-1		14
TY526MR	7TCG009450R0177	12	TY54SMX	7TCG009460R0105	27	TYB24M-2		14
TY526MXR	7TCG009450R0178	13	TY5512M	7TAG009510R0064	35	TYB24M-3		14
TY5271MR	7TCG009450R0180	12	TY551M	7TAG009510R0065	35	TYB24M-4		14
TY5271MXR	7TCG009450R0181	13	TY5532M	7TAG009510R0067	35	TYB24M-5		14
TY5272MR	7TCG009460R0102	12	TY553M	7TAG009510R0069	35	TYB24M-6	7TCG009060R0013	14
TY5272MXR	7TCG009460R0103	13	TY600-120	7TAG054360R0343	47	TYB24M-7		14
TY5275M*	7TAG009290R0004	12	TY600-120X	7TAG054360R0344	47	TYB24M-8		14
TY5275MX*	7TAG009280R0000	13	TY600-120-1		47	TYB24M-9		14
TY5277M*	7TAG009290R0005	12	TY600-120-2		47	TYB24MX	7TCG009960R0069	14
TY5277MX*	7TAG009290R0006	13	TY600-120-3		47	TYB25M	7TCG009450R0193	14
TY527M-NDT	7TAG009660R0034	23	TY600-120-4		47	TYB25M-1		14
TY527M-PDT	7TAG009660R0035	23	TY600-120-5		47	TYB25M-2	7TCG009450R0195	14
TY527MR	7TCG009310R0017	12	TY600-120-6		47	TYB25M-3		14
TY527MXR	7TCG009310R0020	13	TY600-120-7		47	TYB25M-4		14
TY528M-NDT	7TAG009660R0036	23	TY600-120-8		47	TYB25M-5	7TCG009450R0196	14
TY528M-PDT	7TAG009660R0037	23	TY600-120-9		47	TYB25M-6	7TCG009450R0197	14
TY528MR	7TCG009450R0183	12	TY600-175	7TAG054360R0345	49	TYB25M-7		14
TY528MXR	7TCG009200R0025	13	TY600-175X	7TAG054360R0346	49	TYB25M-8		14
TY529M*	7TAG009280R0004	12	TY635M	7TAG009520R0074	26	TYB25M-9		14
TY529MX*	7TAG009280R0004	13	TY635MX	7TAG009520R0075	26	TYB25MX	7TCG009450R0198	14
TY532M	7TAG009510R0050	35	TY800-120	7TAG054360R0347	47	TYC25MX	7TCG009580R0001	21
TY533M	7TAG009520R0062	26	TY800-120X	7TAG054360R0348	47	TYC272MX	7TCG009580R0002	21
TY533MX	7TAG009520R0063	26	TY800-120-1		47	TYC27MX	7TCG009580R0003	21
TY53418PX	7TAG009550R0019	33	TY800-120-2		47	TYC28MX	7TCG009580R0004	21
TY534M	7TAG009520R0064	26	TY800-120-3		47	TYC29MX	7TCG009580R0005	21
TY534MX	7TAG009520R0065	26	TY800-120-4		47	TYC525MX	7TCG009580R0006	21
TY53510M	7TCG009380R0001	9	TY800-120-5		47	TYC527MX	7TCG009580R0007	21
TY53510M-1		11	TY800-120-6		47	TYD-50R	7TAA159090R0005	38
TY53510M-2		11	TY800-120-7		47	TYD-LH	7TAA159090R0006	37
TY53510M-3	7TCG009400R0008	11	TY800-120-8		47	TYD5135M	7TAA159090R0009	37

Index

Produkt Ref.	GID Ref.	Page	Produkt Ref.	GID Ref.	Page	Produkt Ref.	GID Ref.	Page
TYD5270M	7TAA159090R0010	37	YBR-9.5-25BC	7TCG009460R0130	81	YLS-12-1000BC	7TCG009420R0033	75
TYF35M	7TCG009520R0076	26	YBRH-12.7	7TCG009470R0059	81	YLS-12-1200B	7TCG009420R0034	74
TYF535M	7TCG009520R0077	26	YBRH-15.9	7TCG009470R0060	81	YLS-12-1200BC	7TCG009420R0035	75
TYG34M	7TCG009520R0078	28	YBRH-19.1	7TCG009470R0061	81	YLS-12-1400B	7TCG009420R0036	74
TYG34MX	7TCG009520R0079	28	YBRH-6.4	7TCG009470R0062	81	YLS-12-1400BC	7TCG009420R0037	75
TYG534M	7TCG009520R0080	28	YBRH-9.5	7TCG009470R0063	81	YLS-12-200B	7TCG009420R0038	74
TYG534MX	7TCG009520R0081	28	YID-CHAR-1	7TCG009470R0065	80	YLS-12-200BC	7TCG009420R0039	75
TYH232M	7TCG009590R0001	18	YID-CHAR-2	7TCG009470R0066	80	YLS-12-300B	7TCG009420R0040	74
TYH23M	7TCG009590R0002	18	YID-CHAR-3	7TCG009470R0067	80	YLS-12-300BC	7TCG009420R0041	75
TYH242M*	7TCG009590R0003	18	YID-CHAR-4	7TCG009470R0068	80	YLS-12-360B	7TCG009420R0042	74
TYH24M	7TAG009590R0004	18	YID-CHAR-5	7TCG009470R0069	80	YLS-12-360BC	7TCG009420R0043	75
TYH253M*	7TAG009590R0005	18	YID-CHAR-6	7TCG009470R0070	80	YLS-12-440B	7TCG009420R0044	74
TYH25M	7TAG009590R0006	18	YID-CHAR-7	7TCG009470R0071	80	YLS-12-440BC	7TCG009420R0045	75
TYH26M	7TCG009590R0007	18	YID-CHAR-8	7TCG009470R0072	80	YLS-12-520B	7TCG009420R0046	74
TYH272M*	7TCG009590R0008	18	YID-CHAR-A	7TCG009470R0074	80	YLS-12-520BC	7TCG009420R0047	75
TYH27M	7TAG009590R0009	18	YID-CHAR-B	7TCG009470R0075	80	YLS-12-600B	7TCG009420R0048	74
TYH28M	7TAG009590R0010	18	YID-CHAR-BLANK	7TCG009470R0076	80	YLS-12-600BC	7TCG009420R0049	75
TYH29M*	7TCG009590R0011	18	YID-CHAR-C	7TCG009470R0078	80	YLS-12-680B	7TCG009420R0050	74
TYHB23M	7TCG009460R0111	18	YID-CHAR-D	7TCG009470R0079	80	YLS-12-680BC	7TCG009420R0051	75
TYHT23M	7TAG009590R0012	20	YID-CHAR-E	7TCG009470R0080	80	YLS-12-760B	7TCG009420R0052	74
TYHT25M	7TAG009590R0014	20	YID-CHAR-EARTH	7TCG009470R0081	80	YLS-12-760BC	7TCG009420R0053	75
TYHT277M	7TAG009000R0326	20	YID-CHAR-F	7TCG009470R0082	80	YLS-12-840B	7TCG009420R0054	74
TYHT27M	7TAG009590R0015	20	YID-CHAR-G	7TCG009470R0083	80	YLS-12-840BC	7TCG009420R0055	75
TYHT28M	7TAG009590R0016	20	YID-CHAR-H	7TCG009470R0084	80	YLS-16-1000B	7TCG009420R0058	74
TYL300M	7TCG054360R0353	50	YID-CHAR-I	7TCG009470R0085	80	YLS-16-1000BC	7TCG009420R0059	75
TYL300MX	7TCG054360R0354	50	YID-CHAR-J	7TCG009470R0086	80	YLS-16-1200B	7TCG009420R0060	74
TYL546M	7TCG054360R0355	50	YID-CHAR-K	7TCG009470R0087	80	YLS-16-1200BC	7TCG009420R0061	75
TYL546MX	7TCG054360R0356	50	YID-CHAR-L	7TCG009470R0088	80	YLS-16-1400B	7TCG009420R0062	74
TYP23MX	7TAG009600R0000	22	YID-CHAR-M	7TCG009470R0089	80	YLS-16-1400BC	7TCG009420R0063	75
TYP25MX	7TAG009600R0001	22	YID-CHAR-MINUS	7TCG009470R0090	80	YLS-16-200B	7TCG009420R0064	74
TYP27MX	7TAG009600R0002	22	YID-CHAR-N	7TCG009470R0091	80	YLS-16-200BC	7TCG009420R0065	75
TYP28MX	7TAG009600R0003	22	YID-CHAR-O	7TCG009470R0092	80	YLS-16-300B	7TCG009420R0066	74
TYR505	7TAG009540R0001	31	YID-CHAR-P	7TCG009470R0093	80	YLS-16-300BC	7TCG009420R0067	75
TYR508	7TAG009540R0002	31	YID-CHAR-PLUS	7TCG009470R0094	80	YLS-16-360B	7TCG009420R0068	74
TYRAP PROF KIT	7TCA131140R0023	16	YID-CHAR-Q	7TCG009470R0095	80	YLS-16-360BC	7TCG009420R0069	75
TYS1000	7TAG009460R0112	78	YID-CHAR-R	7TCG009470R0096	80	YLS-16-440B	7TCG009420R0070	74
TYS14	7TAG009450R0203	78	YID-CHAR-S	7TCG009470R0097	80	YLS-16-440BC	7TCG009420R0071	75
TYS22	7TAG009460R0116	78	YID-CHAR-SINE	7TCG009470R0098	80	YLS-16-520B	7TCG009420R0072	74
TYS28	7TAG009460R0121	78	YID-CHAR-SLASH	7TCG009470R0099	80	YLS-16-520BC	7TCG009420R0073	75
TYS5200H	7TAG009470R00058	78	YID-CHAR-T	7TCG009470R0100	80	YLS-16-600B	7TCG009420R0074	74
TYS8	7TAG009460R0124	78	YID-CHAR-U	7TCG009470R0101	80	YLS-16-600BC	7TCG009420R0075	75
TYV23M	7TAG009000R0330	24	YID-CHAR-V	7TCG009470R0102	80	YLS-16-680B	7TCG009420R0076	74
TYV25M	7TAG009610R0000	24	YID-CHAR-W	7TCG009470R0103	80	YLS-16-680BC	7TCG009420R0077	75
TYV523M	7TAG009610R0001	24	YID-CHAR-X	7TCG009470R0104	80	YLS-16-760B	7TCG009420R0078	74
TYV525M	7TAG009610R0002	24	YID-CHAR-Y	7TCG009470R0105	80	YLS-16-760BC	7TCG009420R0079	75
TYZ23M*	7TAG009620R0000	25	YID-CHAR-Z	7TCG009470R0106	80	YLS-16-840B	7TCG009420R0080	74
TYZ25M	7TAG009620R0002	25	YLD-12-150-B	7TCG009460R0133	76	YLS-16-840BC	7TCG009420R0081	75
TYZ27M	7TAG009620R0004	25	YLD-12-150-BC	7TCG009450R0210	77	YLS-4.6-1000A	7TCG009410R0009	72
TYZ28M	7TAG009620R0005	25	YLD-12-225-B	7TCG009460R0136	76	YLS-4.6-1000B	7TCG009420R0084	72
TYZ523M*	7TAG009620R0006	25	YLD-12-225-BC	7TCG009450R0211	77	YLS-4.6-1000BC	7TCG009420R0085	73
TYZ525M	7TAG009620R0007	25	YLD-12-300-B	7TCG009450R0212	76	YLS-4.6-100A	7TCG009410R0010	72
TYZ527M	7TAG009620R0008	25	YLD-12-300-BC	7TCG009450R0213	77	YLS-4.6-100B	7TCG009410R0011	72
TYZ528M	7TAG009620R0009	25	YLD-12-450-B	7TCG009450R0214	76	YLS-4.6-100BC	7TCG009410R0012	73
ULNY-013-8-C	7TAG009970R0153	111	YLD-12-450-BC	7TCG009450R0215	77	YLS-4.6-1200A	7TCG009420R0086	72
ULNY-018-8-C	7TAG009970R0155	111	YLD-12-610-B	7TCG009460R0143	76	YLS-4.6-1200B	7TCG009420R0087	72
ULNY-023-8-C	7TAG009970R0156	111	YLD-12-610-BC	7TCG009460R0144	77	YLS-4.6-1200BC	7TCG009420R0088	73
WT-HSG	7TCA131140R0028	126	YLD-7-150-B	7TCG009450R0217	76	YLS-4.6-125A	7TCG009410R0013	72
WT1-TB	7TAA131800R0004	134, 139	YLD-7-150-BC	7TCG009450R0218	77	YLS-4.6-125B	7TCG009410R0014	72
WT197	7TAA131800R0005	134, 137	YLD-7-225-B	7TCG009450R0219	76	YLS-4.6-125BC	7TCG009420R0089	73
WT199	7TAA131800R0006	134, 137	YLD-7-225-BC	7TCG009450R0220	77	YLS-4.6-1400A	7TCG009420R0090	72
WT2-TB	7TAA131800R0007	134, 139	YLD-7-300-B	7TCG009450R0221	76	YLS-4.6-1400B	7TCG009420R0091	72
WT3D	7TAA131800R0008	134, 138	YLD-7-300-BC	7TCG009450R0222	77	YLS-4.6-1400BC	7TCG009420R0092	73
WT3S	7TAA131810R0002	134, 140	YLD-7-450-B	7TCG009460R0157	76	YLS-4.6-150A	7TCG009410R0015	72
YBR-12.7-25BC	7TCG009460R0126	81	YLD-7-450-BC	7TCG009450R0223	77	YLS-4.6-150B	7TCG009420R0093	72
YBR-15.9-25BC	7TCG009460R0127	81	YLD-7-610-B	7TCG009450R0224	76	YLS4.6-150BC	7TCG009410R0034	73
YBR-19.1-25BC	7TCG009460R0128	81	YLD-7-610-BC	7TCG009450R0225	77	YLS4.6-200A	7TCG009410R0035	72
YBR-6.4-25BC	7TCG009460R0129	81	YLS-12-1000B	7TCG009420R0032	74	YLS4.6-200B	7TCG009410R0036	72

Index

Produkt Ref.	GID Ref.	Page
YLS-4.6-200BC	7TCG009420R0094	73
YLS-4.6-300A	7TCG009410R0016	72
YLS-4.6-300B	7TCG009410R0017	72
YLS-4.6-300BC	7TCG009410R0018	73
YLS4.6-360A	7TCG009410R0037	72
YLS4.6-360B	7TCG009410R0038	72
YLS-4.6-360BC	7TCG009420R0098	73
YLS4.6-520A	7TCG009410R0039	72
YLS-4.6-520B	7TCG009410R0019	72
YLS-4.6-520BC	7TCG009420R0101	73
YLS-4.6-680A	7TCG009410R0020	72
YLS-4.6-680B	7TCG009410R0021	72
YLS-4.6-680BC	7TCG009410R0022	73
YLS-4.6-840A	7TCG009420R0102	72
YLS-4.6-840B	7TCG009420R0103	72
YLS-4.6-840BC	7TCG009420R0104	73
YLS-7.9-1000A	7TCG009410R0023	72
YLS-7.9-1000B	7TCG009420R0105	72
YLS-7.9-1000BC	7TCG009420R0106	73
YLS-7.9-100A	7TCG009420R0107	72
YLS-7.9-100B	7TCG009420R0108	72
YLS-7.9-100BC	7TCG009420R0109	73
YLS-7.9-1200A	7TCG009420R0110	72
YLS-7.9-1200B	7TCG009420R0111	72
YLS-7.9-1200BC	7TCG009420R0112	73
YLS-7.9-125A	7TCG009420R0113	72
YLS-7.9-125B	7TCG009420R0114	72
YLS-7.9-125BC	7TCG009420R0115	73
YLS-7.9-1400A	7TCG009420R0116	72
YLS-7.9-1400B	7TCG009420R0117	72
YLS-7.9-1400BC	7TCG009420R0118	73
YLS-7.9-150A	7TCG009420R0119	72
YLS-7.9-150B	7TCG009420R0120	72
YLS-7.9-150BC	7TCG009410R0024	73
YLS7.9-200A	7TCG009410R0040	72
YLS-7.9-200B	7TCG009410R0025	72
YLS-7.9-200BC	7TCG009420R0122	73
YLS-7.9-300A	7TCG009410R0026	72
YLS-7.9-300B	7TCG009410R0027	72
YLS-7.9-300BC	7TCG009410R0028	73
YLS7.9-360A	7TCG009410R0041	72
YLS-7.9-360B	7TCG009410R0029	72
YLS-7.9-360BC	7TCG009410R0030	73
YLS7.9-520A	7TCG009410R0042	72
YLS-7.9-520B	7TCG009410R0031	72
YLS-7.9-520BC	7TCG009420R0124	73
YLS-7.9-680A	7TCG009420R0125	72
YLS-7.9-680B	7TCG009410R0032	72
YLS-7.9-680BC	7TCG009420R0126	73
YLS-7.9-840A	7TCG009420R0127	72
YLS-7.9-840B	7TCG009410R0033	72
YLS-7.9-840BC	7TCG009420R0128	73
YRL-10-150-BC	7TCG009210R0062	79
YRL-10-230-BC	7TCG009210R0064	79
YRL-10-330-BC	7TCG009210R0066	79
YRL-10-450-BC	7TCG009210R0068	79
YRL-10-650-BC	7TCG009210R0070	79
YRL-10-750-BC	7TCG009210R0072	79
YRL-5-150-BC	7TCG009210R0075	79
YRL-5-230-BC	7TCG009210R0077	79
YRL-5-330-BC	7TCG009210R0079	79
YRL-5-450-BC	7TCG009210R0081	79
YRL-5-650-BC	7TCG009210R0083	79

Notes

A series of horizontal dotted lines for writing notes.