

Features

- Surface Mount Package Ideally Suited for Automated Insertion
- Suitable for ultra-low leakage current applications, including high-precision instrumentation and portable electronics
- **Lead Free By Design/RoHS Compliant (Note 1)**
- **Halogen and Antimony Free "Green" Device (Notes 2 & 3)**
- **Qualified to AEC-Q101 Standards for High Reliability**

Mechanical Data

- Case: SOT323
- Case Material: Molded Plastic, "Green" Molding Compound. UL Flammability Classification Rating 94V-0
- Moisture Sensitivity: Level 1 per J-STD-020
- Terminals: Finish — Matte Tin Finish annealed over Alloy 42 leadframe. Solderable per MIL-STD-202, Method 208
- Polarity: See Diagram
- Weight: 0.006 grams (approximate)

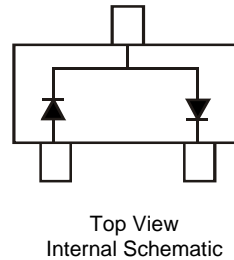
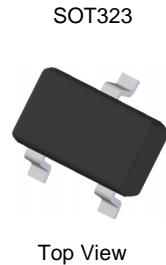

Ordering Information (Notes 4 & 5)

Part Number	Case	Packaging
BAV199W-7	SOT323	3,000/Tape & Reel

- Notes:
1. Fully EU Directive 2002/95/EC (RoHS) & 2011/65/EU (RoHS 2) compliant. No purposely added lead.
 2. Halogen and Antimony free "Green" products are defined as those which contain <900ppm bromine, <900ppm chlorine (<1500ppm total Br + Cl) and <1000ppm antimony compounds.
 3. Diodes Inc.'s "Green" Policy can be found on our website at <http://www.diodes.com>
 4. For packaging details, go to our website at <http://www.diodes.com>.
 5. Product manufactured with Date Code V9 (week 33, 2008) and newer are built with Green Molding Compound. Product manufactured prior to Date Code V9 are built with Non-Green Molding Compound and may contain Halogens or Sb2O3 Fire Retardants.

Marking Information

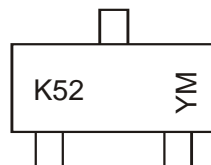

K52= Product Type Marking Code
 YM = Date Code Marking
 Y = Year (ex: Z = 2012)
 M = Month (ex: 9 = September)

Date Code Key

Year	2004	2005	2012	2013	2014	2015	2016	2017
Code	R	S	Z	A	B	C	D	E

Month	Jan	Feb	Mar	Apr	May	Jun	Jul	Aug	Sep	Oct	Nov	Dec
Code	1	2	3	4	5	6	7	8	9	O	N	D

Maximum Ratings @ $T_A = 25^\circ\text{C}$ unless otherwise specified

Characteristic	Symbol	Value	Unit	
Peak Repetitive Reverse Voltage	V_{RRM}	85	V	
Working Peak Reverse Voltage	V_{RWM}			
DC Blocking Voltage	V_R			
RMS Reverse Voltage	$V_{R(RMS)}$	60	V	
Forward Continuous Current (Note 6)	Single diode Double diode	I_{FM}	160 140	mA
		I_{FRM}	500	mA
Repetitive Peak Forward Current (Note 6)				
Non-Repetitive Peak Forward Surge Current		@ $t = 1.0\mu\text{s}$	4.0	A
		@ $t = 1.0\text{ms}$	1.0	
		@ $t = 1.0\text{s}$	0.5	

Thermal Characteristics

Characteristic	Symbol	Value	Unit
Power Dissipation (Note 6)	P_D	200	mW
Thermal Resistance Junction to Ambient Air (Note 6)	$R_{\theta JA}$	625	$^\circ\text{C}/\text{W}$
Operating and Storage Temperature Range	T_J, T_{STG}	-65 to +150	$^\circ\text{C}$

Electrical Characteristics @ $T_A = 25^\circ\text{C}$ unless otherwise specified

Characteristic	Symbol	Min	Typ	Max	Unit	Test Condition
Reverse Breakdown Voltage (Note 7)	$V_{(BR)R}$	85	—	—	V	$I_R = 100\mu\text{A}$
Forward Voltage	V_F	—	—	0.90 1.0 1.1 1.25	V	$I_F = 1.0\text{mA}$ $I_F = 10\text{mA}$ $I_F = 50\text{mA}$ $I_F = 150\text{mA}$
Leakage Current (Note 7)	I_R	—	—	5.0 80	nA nA	$V_R = 75\text{V}$ $V_R = 75\text{V}, T_J = 150^\circ\text{C}$
Total Capacitance	C_T	—	2	—	pF	$V_R = 0, f = 1.0\text{MHz}$
Reverse Recovery Time	t_{rr}	—	—	3.0	μs	$I_F = I_R = 10\text{mA}$, $I_{rr} = 0.1 \times I_R, R_L = 100\Omega$

Notes: 6. Part mounted on FR-4 PC board with recommended pad layout, which can be found on our website at <http://www.diodes.com>.
7. Short duration pulse test used to minimize self-heating effect.

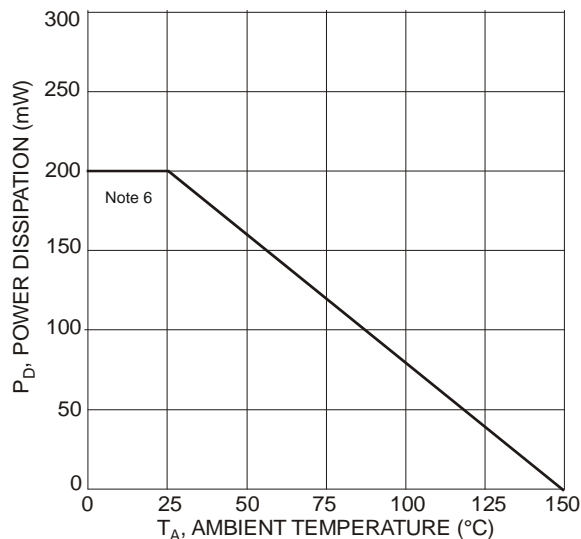

Fig. 1 Power Derating Curve, Total Package

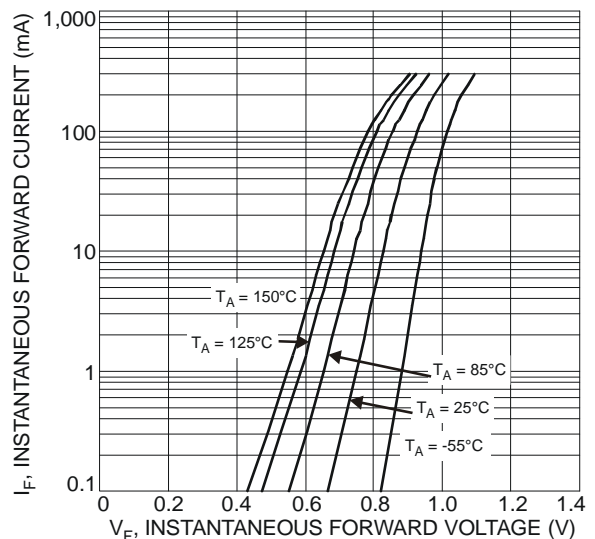

Fig. 2 Typical Forward Characteristics

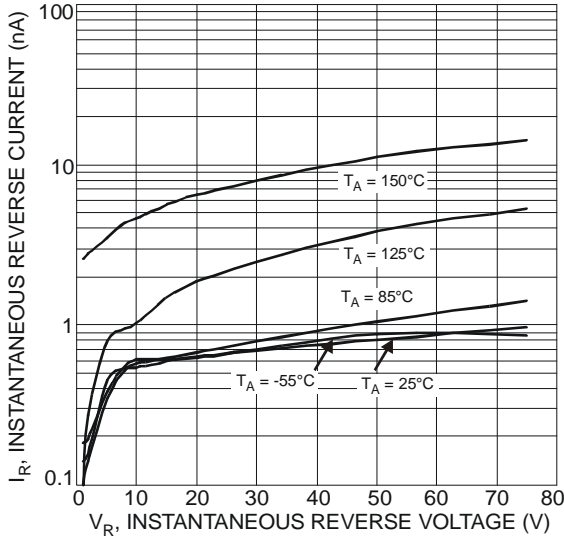

Fig. 3 Typical Reverse Characteristics

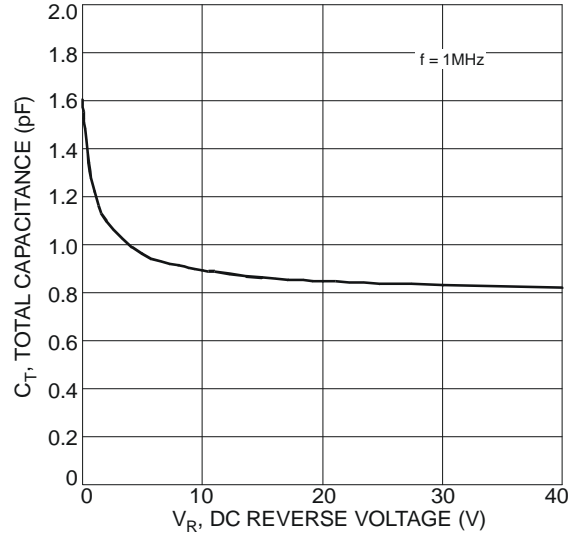

Fig. 4 Total Capacitance vs. Reverse Voltage

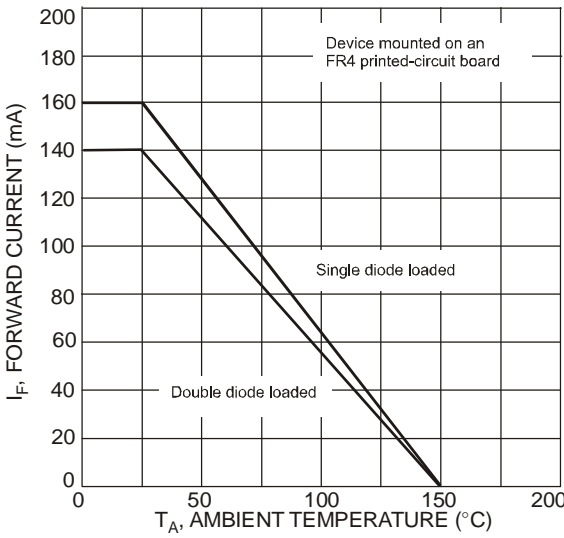
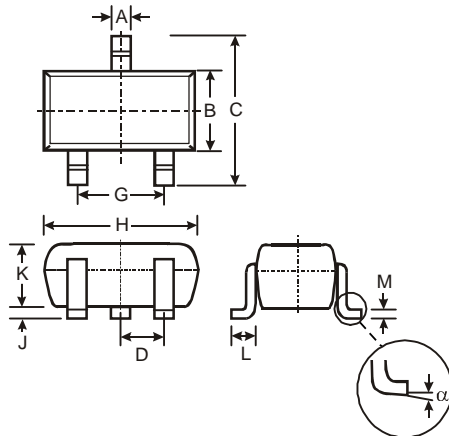

Fig. 5 Current Derating Curve, Per Element

Package Outline Dimensions



SOT323			
Dim	Min	Max	Typ
A	0.25	0.40	0.30
B	1.15	1.35	1.30
C	2.00	2.20	2.10
D	-	-	0.65
G	1.20	1.40	1.30
H	1.80	2.20	2.15
J	0.0	0.10	0.05
K	0.90	1.00	1.00
L	0.25	0.40	0.30
M	0.10	0.18	0.11
α	0°	8°	-
All Dimensions in mm			

Suggested Pad Layout

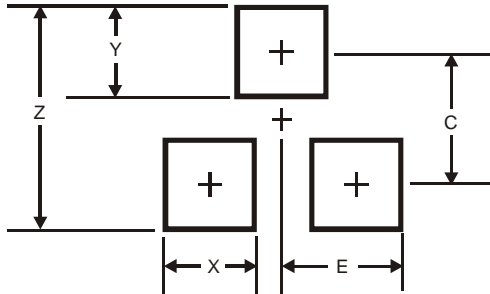

Dimensions	Value (in mm)
Z	2.8
X	0.7
Y	0.9
C	1.9
E	1.0

IMPORTANT NOTICE

DIODES INCORPORATED MAKES NO WARRANTY OF ANY KIND, EXPRESS OR IMPLIED, WITH REGARDS TO THIS DOCUMENT, INCLUDING, BUT NOT LIMITED TO, THE IMPLIED WARRANTIES OF MERCHANTABILITY AND FITNESS FOR A PARTICULAR PURPOSE (AND THEIR EQUIVALENTS UNDER THE LAWS OF ANY JURISDICTION).

Diodes Incorporated and its subsidiaries reserve the right to make modifications, enhancements, improvements, corrections or other changes without further notice to this document and any product described herein. Diodes Incorporated does not assume any liability arising out of the application or use of this document or any product described herein; neither does Diodes Incorporated convey any license under its patent or trademark rights, nor the rights of others. Any Customer or user of this document or products described herein in such applications shall assume all risks of such use and will agree to hold Diodes Incorporated and all the companies whose products are represented on Diodes Incorporated website, harmless against all damages.

Diodes Incorporated does not warrant or accept any liability whatsoever in respect of any products purchased through unauthorized sales channel. Should Customers purchase or use Diodes Incorporated products for any unintended or unauthorized application, Customers shall indemnify and hold Diodes Incorporated and its representatives harmless against all claims, damages, expenses, and attorney fees arising out of, directly or indirectly, any claim of personal injury or death associated with such unintended or unauthorized application.

Products described herein may be covered by one or more United States, international or foreign patents pending. Product names and markings noted herein may also be covered by one or more United States, international or foreign trademarks.

LIFE SUPPORT

Diodes Incorporated products are specifically not authorized for use as critical components in life support devices or systems without the express written approval of the Chief Executive Officer of Diodes Incorporated. As used herein:

A. Life support devices or systems are devices or systems which:

1. are intended to implant into the body, or
2. support or sustain life and whose failure to perform when properly used in accordance with instructions for use provided in the labeling can be reasonably expected to result in significant injury to the user.

B. A critical component is any component in a life support device or system whose failure to perform can be reasonably expected to cause the failure of the life support device or to affect its safety or effectiveness.

Customers represent that they have all necessary expertise in the safety and regulatory ramifications of their life support devices or systems, and acknowledge and agree that they are solely responsible for all legal, regulatory and safety-related requirements concerning their products and any use of Diodes Incorporated products in such safety-critical, life support devices or systems, notwithstanding any devices- or systems-related information or support that may be provided by Diodes Incorporated. Further, Customers must fully indemnify Diodes Incorporated and its representatives against any damages arising out of the use of Diodes Incorporated products in such safety-critical, life support devices or systems.

Copyright © 2012, Diodes Incorporated

www.diodes.com

Mouser Electronics

Authorized Distributor

Click to View Pricing, Inventory, Delivery & Lifecycle Information:

[Diodes Incorporated:](#)

[BAV199W-7](#)