

Product Data Sheet 8218 JH4

ebmpapst

The engineer's choice



8218 JH4

INDEX

1 General 3

2 Mechanics 3

2.1 General 3

2.2 Connections 3

3 Operating Data 4

3.1 Electrical Operating Data 4

3.2 Electrical Features 4

3.3 Aerodynamics 5

3.4 Sound Data 6

4 Environment 6

4.1 General 6

4.2 Climatic Requirements 6

5 Safety 7

5.1 Electrical Safety 7

5.2 Approval Tests 7

6 Reliability 7

6.1 General 7

1 General

Fan type	Fan	
Rotating direction looking at rotor	Counterclockwise	
Airflow direction	Air outlet over struts	
Bearing system	Ball bearing	
Mounting position - shaft	Any	

2 Mechanics

2.1 General

Width	80,0 mm	
Height	80,0 mm	
Depth	38,0 mm	
Mass	0,210 kg	
Housing material	Plastic	
Impeller material	Plastic	
Max. torque when mounted across both mounting flanges	wire outlet corner: 50 Ncm remaining corners: 110 Ncm	
Screw size	ISO 4762 - M4 degreased, without an additional brace and without washer	

2.2 Connections

Electrical connection	Wires	
Lead wire length	L = 310 mm	
Tolerance	+ - 10,0 mm	
Wire size (AWG)	22	
Insulation diameter	1,30 mm	
Contact	See drawing	

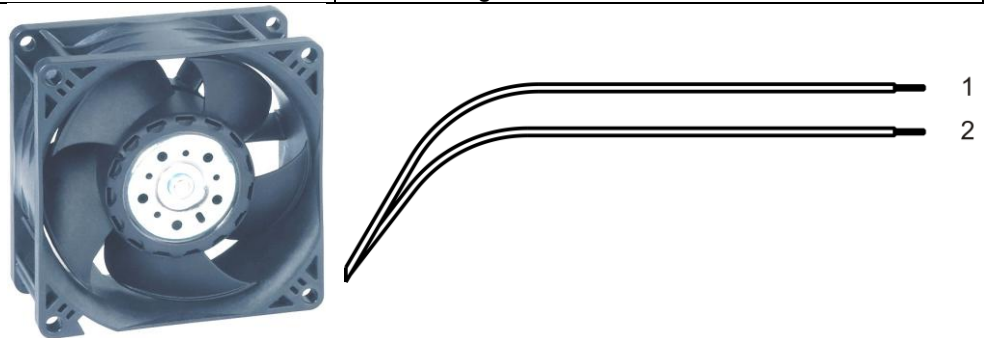

Wire	Colour	Operation
1	red	+ UB
2	blue	- GND

3 Operating Data

3.1 Electrical Operating Data

Measurement conditions: Normal air density = 1,2 kg/m³; Temperature 23°C +/- 3°C; Motor axis horizontal; warm-up time before measuring 5 minutes (unless otherwise specified). In the intake and outlet area should not be any solid obstruction within 0,5 m.

$\Delta p = 0$: corresp. to free air flow (see section 3.5)
 I: corresp. to arithm. mean current value

Features	Condition	Symbol	Values		
Voltage range		U	20 V		58,0 V
Nominal voltage		U_N		48,0 V	
Power consumption	$\Delta p = 0$	P	6 W	37 W	37,0 W
Tolerance	0010		+/- 17,5 %	+/- 17,5 %	+/- 25,0 %
Current consumption	$\Delta p = 0$	I	300 mA	770 mA	650 mA
Tolerance	0010		+/- 17,5 %	+/- 17,5 %	+/- 25,0 %
Speed	$\Delta p = 0$	n	7.300 1/min	14.000 1/min	14.000 1/min
Tolerance	0010		+/- 12,5 %	+/- 7,5 %	+/- 3,0 %

3.2 Electrical Features

Electronic function	Speed-Controlled	
Reversed polarity protection	Rectifying diode	
Max. residual current at U_N	$I_F \leq 100 \mu A$	
Locked rotor protection	Auto restart	
Locked rotor current at U_N	I_{block} approx. 11.000 mA	
Clock signal at locked rotor	t_3 / t_4 Typical: 0,5 s / 10,0 s	

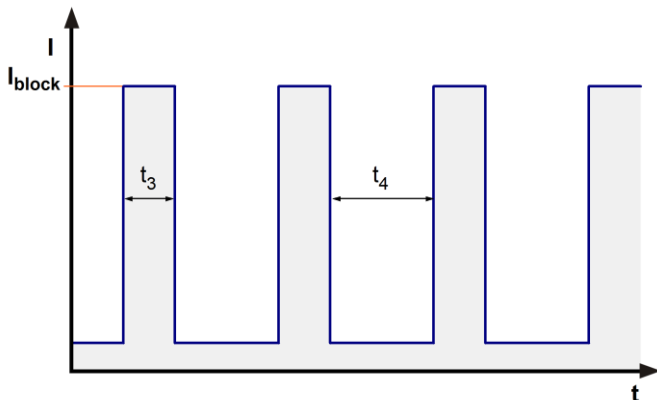

3.3 Aerodynamics

Measurement conditions: Measured with a double chamber intake rig acc. to DIN EN ISO 5801.
 Normal air density = 1,2 kg/m³; Temperature 23°C +/- 3°C;
 In the intake and outlet area should not be any solid obstruction within 0,5 m.
 The information is only valid under the specified test conditions and may be changed by the installation conditions. If there are deviations from the standard test conditions, the characteristic values must be checked under the installed conditions.

a.) Operation condition:

14.000 1/min at free air flow

Max. free-air flow ($\Delta p = 0 / \dot{V} = \text{max.}$)	220,0 m ³ /h	
Max. static pressure ($\Delta p = \text{max.} / \dot{V} = 0$)	710 Pa	

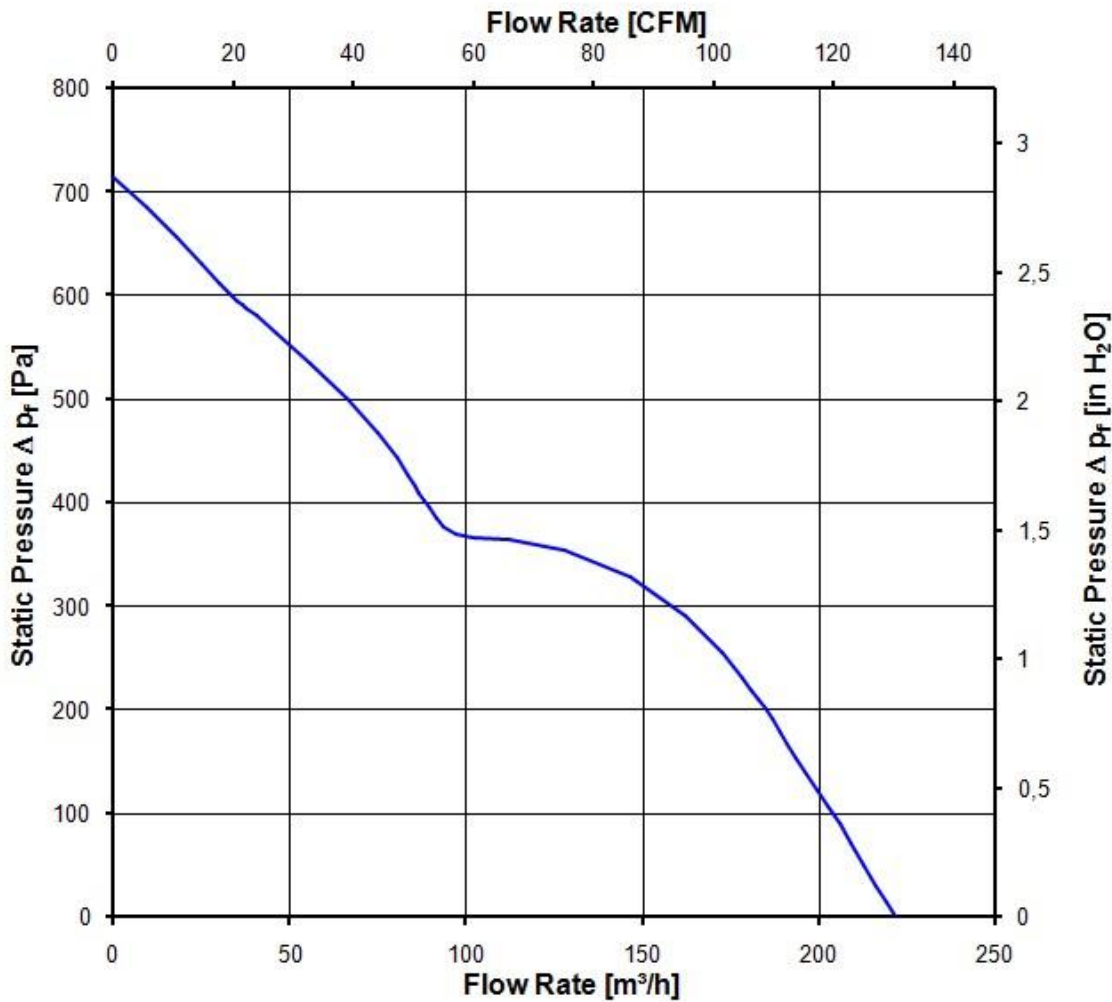

3.4 Sound Data

Measurement conditions: Sound pressure level: 1 Meter distance between microphone and the air intake.
 Sound power level: Acc. to DIN 45635 part 38 (ISO 10302)
 Measured in a semianchoic chamber with a background noise level of $L_p(A) < 5 \text{ dB(A)}$
 For further measurement conditions see section 3.5

a.) Operation condition:

14.000 1/min at free air flow		
Optimal operating point	135,0 m3/h @ 330 Pa	
Sound power level at the optimal operating point	8,0 bel(A)	
Sound pressure level at free air flow, measured in rubber bands	71,0 dB(A)	

4 Environment

4.1 General

Min. permitted ambient temperature TU min.	-20 °C	
Max. permitted ambient temperature TU max.	70 °C	
Min. permitted storage temperature TL min.	-40 °C	
Max. permitted storage temperature TL max.	80 °C	

4.2 Climatic Requirements

Humidity requirements	humid heat, constant; according to DIN EN 60068-2-78, 14 days	
Water exposure	None	
Dust requirements	None	
Salt fog requirements	None	

*) Permitted application area:

The product is intended for use in sheltered rooms with controlled temperature and controlled humidity. Directly exposure to water must be avoided.

Pollution degree 1 (according DIN EN 60664-1)

There is either no pollution or it occurs only dry, non-conductive pollution. The pollution has no negative impact. Please require severity levels and specification parameters from the responsible development departments

5 Safety

5.1 Electrical Safety

Dielectric strength DIN EN 60950 (VDE 0805) and DIN EN 60335 (VDE 0700) A.) Type test Measuring conditions: After 48h of storage at 95% R.H. and 25°C. No arcing or breakdown is allowed! All connections together to ground.	500 VAC / 1 Min.	
B.) Routine test Measuring conditions: At indoor climate. No arcing or breakdown is allowed! All connections together to ground.	500 VAC / 1 Sec.	
Isolation resistance Measuring conditions: After 48h of storage at 95% R.H. and 25°C measured with U=500 VDC for 1 min.	RI > 10 MOhm	
clearance / creepage distance	1,0 mm / 1,2 mm	
Protection class	III	

5.2 Approval Tests

CE	EC Declaration of Conformity	Yes
EAC	Eurasian Conformity	Yes
UL	Underwriters Laboratories	Yes / UL507, Electric Fans
VDE	Association for Electrical, Electronic and Information Technologies	Yes / Approval acc. to EN 60950 (VDE 0805) - Information technology equipment
CSA	Canadian Standards Association	Yes / C22.2 No. 113 Fans and Ventilators
CCC	China Compulsory Certification	Yes / GB 12350 Safety Requirements for small Power Motors

The approval tests are observed to:

U approval max.: 52,8 V @ TU approval max.: 70,0 °C

6 Reliability

6.1 General

Life expectancy L10 at TU = 40 °C	50.000 h	
Life expectancy L10 at TU max.	25.000 h	
Life expectancy L10 acc. to IPC 9591 at TU = 40 °C	85.000 h	

Copying of this document, and giving it others and the use or communication of the contents thereof, are forbidden without express authority. Offenders are liable to the payment of damages. All rights are reserved in the event of the grant of a patent or the registration of a utility model or design.

Schutzmerk nach DIN ISO 10161 beachten!
Refer to protection notice DIN ISO 10161!

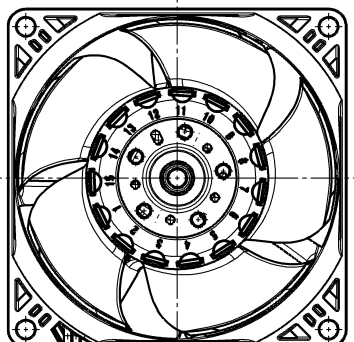
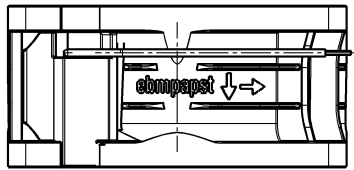

ⓑ L

6 ± 0.3
verzinkt
tinned

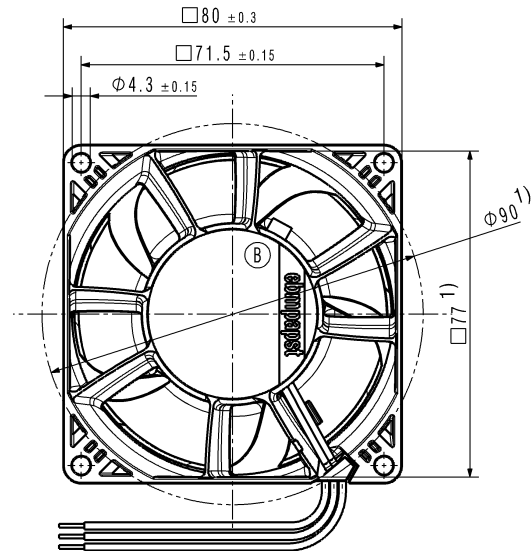
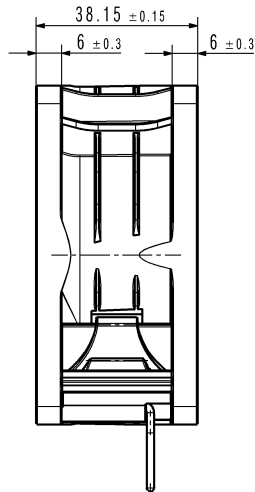

- 1) Maße für Montagewand
- 1) dimension for worktop mounting

Laenge und Anzahl der Litzen siehe Produktspezifikation
length and number of the wires, look at the produkt specification

Kein Axialspiel bei Kugellager durch Federausgleich
no axial clearance of ball bearings conditional on a pre-load spring

SAP-Status/State	Änd.-Nr./ Change-No.	CATIA-System-Version/ CATIA-System-Version	CAD-Umgebung/ CAD-Environment	Werkstoff / Material:	Volumen / Volume (cm³):
		9992910161 CPRO00E			Gewicht / Mass (g):
		3D-Referenzmodell / 3D-Referenzmodell:		Artikel / Title:	
Tolerierung / Tolerances:		Datum	Name		
Allgemeintoleranzen / Gen. Tolerances:		Bearb./ Drawn		Zug.-Nr. / Drawing No:	
		Gepr./ Checked		Ers.-f.-Zug. / Replaces:	
		Freig./ Released			
ebmpapst			Dokumenttyp / Type of Document	Teil/Lockument (Blatt/Page)	Index / Index:
ebm-papst St. Georgen GmbH & Co KG				Format / Size:	Masstab/Scale

Mouser Electronics

Authorized Distributor

Click to View Pricing, Inventory, Delivery & Lifecycle Information:

[ebm-papst:](#)

[8218J/2H4](#) [8212J/2H4](#) [8214J/2H4](#) [8214JH4](#) [8218JH4](#) [8212JH4](#) [8214J/2H3](#) [8218JH3](#) [8212JH3](#) [8214JH3](#)