

# PTA 1,5/ 4-5,0 - PCB terminal block



1988820

<https://www.phoenixcontact.com/us/products/1988820>

Please be informed that the data shown in this PDF document is generated from our online catalog. Please find the complete data in the user documentation. Our general terms of use for downloads are valid.



PCB terminal block, nominal current: 17.5 A, rated voltage (III/2): 400 V, nominal cross section: 1.5 mm<sup>2</sup>, number of potentials: 4, number of rows: 1, number of positions per row: 4, product range: PTA 1,5, pitch: 5 mm, connection method: Screw connection with wire protector, mounting: Wave soldering, conductor/PCB connection direction: 45 °, color: green, Pin layout: Linear front pinning, Solder pin [P]: 3.5 mm, number of solder pins per potential: 1, type of packaging: packed in cardboard

## Your advantages

- Well-known connection principle allows worldwide use
- Low temperature rise, thanks to maximum contact force
- High terminal block capacity thanks to rectangular terminal block space
- Allows connection of two conductors
- Angled connection enables multi-row arrangement on the PCB
- The latching on the side enables various numbers of positions to be combined

## Commercial data

Item number	1988820
Packing unit	250 pc
Minimum order quantity	250 pc
Sales key	AA12
Product key	AALFMF
Catalog page	Page 421 (C-1-2013)
GTIN	4046356036818
Weight per piece (including packing)	4.102 g
Weight per piece (excluding packing)	4.096 g
Customs tariff number	85369010
Country of origin	IN

# PTA 1,5/ 4-5,0 - PCB terminal block



1988820

<https://www.phoenixcontact.com/us/products/1988820>

## Technical data

### Product properties

Product type	Printed circuit board terminal
Product family	PTA 1,5
Product line	COMBICON Terminals S
Type	PC termination block
Number of positions	4
Pitch	5 mm
Number of connections	4
Number of rows	1
Number of potentials	4
Pin layout	Linear front pinning
Solder pins per potential	1

### Electrical properties

Nominal current $I_N$	17.5 A
Nominal voltage $U_N$	400 V
Degree of pollution	3
Rated voltage (III/3)	250 V
Rated surge voltage (III/3)	4 kV
Rated voltage (III/2)	400 V
Rated surge voltage (III/2)	4 kV
Rated voltage (II/2)	630 V
Rated surge voltage (II/2)	4 kV

### Connection data

#### Connection technology

Type	PC termination block
Nominal cross section	1.5 mm <sup>2</sup>

#### Conductor connection

Connection method	Screw connection with wire protector
Conductor cross section rigid	0.14 mm <sup>2</sup> ... 2.5 mm <sup>2</sup>
Conductor cross section flexible	0.14 mm <sup>2</sup> ... 2.5 mm <sup>2</sup>
Conductor cross section AWG	26 ... 14
Conductor cross section flexible, with ferrule without plastic sleeve	0.25 mm <sup>2</sup> ... 1.5 mm <sup>2</sup>
Conductor cross section, flexible, with ferrule, with plastic sleeve	0.25 mm <sup>2</sup> ... 1.5 mm <sup>2</sup>
2 conductors with same cross section, solid	0.14 mm <sup>2</sup> ... 1 mm <sup>2</sup>
2 conductors with same cross section, flexible	0.14 mm <sup>2</sup> ... 0.75 mm <sup>2</sup>
2 conductors with same cross section, flexible, with ferrule without plastic sleeve	0.25 mm <sup>2</sup> ... 0.34 mm <sup>2</sup>
2 conductors with the same cross section, flexible, with TWIN	0.25 mm <sup>2</sup> ... 0.75 mm <sup>2</sup>

# PTA 1,5/ 4-5,0 - PCB terminal block

1988820

<https://www.phoenixcontact.com/us/products/1988820>

ferrule with plastic sleeve	
Stripping length	5 mm
Tightening torque	0.35 Nm ... 0.4 Nm

## Mounting

Mounting type	Wave soldering
Pin layout	Linear front pinning

## Material specifications

### Material data - contact

Note	WEEE/RoHS-compliant, free of whiskers according to IEC 60068-2-82/JEDEC JESD 201
Contact material	Cu alloy
Surface characteristics	Tin-plated
Metal surface terminal point (top layer)	Tin (3 - 12 $\mu\text{m}$ Sn)
Metal surface terminal point (middle layer)	Nickel (1.5 - 4 $\mu\text{m}$ Ni)
Metal surface soldering area (top layer)	Tin (3 - 12 $\mu\text{m}$ Sn)
Metal surface soldering area (middle layer)	Nickel (1.5 - 4 $\mu\text{m}$ Ni)

### Material data - housing

Color (Housing)	green (6021)
Insulating material	PA
Insulating material group	I
CTI according to IEC 60112	600
Flammability rating according to UL 94	V0
Glow wire flammability index GWFI according to EN 60695-2-12	850
Glow wire ignition temperature GWIT according to EN 60695-2-13	775
Temperature for the ball pressure test according to EN 60695-10-2	125 °C

## Dimensions

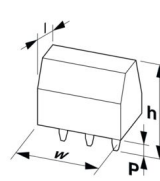
Dimensional drawing	
Pitch	5 mm
Width [w]	20 mm
Height [h]	15.4 mm
Length [l]	12.8 mm
Installed height	11.9 mm
Solder pin length [P]	3.5 mm
Pin dimensions	$\varnothing$ 1 mm

# PTA 1,5/ 4-5,0 - PCB terminal block



1988820

<https://www.phoenixcontact.com/us/products/1988820>

## PCB design

Pin spacing	5 mm
Hole diameter	1.3 mm

## Mechanical tests

### Test for conductor damage and slackening

Specification	IEC 60999-1:1999-11
Result	Test passed

### Pull-out test

Specification	IEC 60999-1:1999-11
Conductor cross section/conductor type/tractive force setpoint/actual value	0.14 mm <sup>2</sup> / solid / > 10 N
	0.14 mm <sup>2</sup> / flexible / > 10 N
	2.5 mm <sup>2</sup> / solid / > 50 N
	2.5 mm <sup>2</sup> / flexible / > 50 N

## Electrical tests

### Temperature-rise test

Specification	IEC 60947-7-4:2019-01
Requirement temperature-rise test	The sum of ambient temperature and temperature rise of the PCB terminal block shall not exceed the upper limiting temperature.

### Short-time withstand current

Specification	IEC 60947-7-4:2019-01
---------------	-----------------------

### Insulation resistance

Specification	IEC 60512-3-1:2002-02
Insulation resistance, neighboring positions	> 5 MΩ

### Air clearances and creepage distances |

Specification	IEC 60947-1:2007-06 + A1:2010-12 + A2:2014-09
Insulating material group	I
Comparative tracking index (IEC 60112)	CTI 600
Rated insulation voltage (III/3)	250 V
Rated surge voltage (III/3)	4 kV
minimum clearance value - non-homogenous field (III/3)	3 mm
minimum creepage distance (III/3)	3.2 mm
Note on connection cross section	With connected conductor 2.5 mm <sup>2</sup> (solid).
Rated insulation voltage (III/2)	400 V
Rated surge voltage (III/2)	4 kV
minimum clearance value - non-homogenous field (III/2)	3 mm
minimum creepage distance (III/2)	3 mm
Rated insulation voltage (II/2)	630 V
Rated surge voltage (II/2)	4 kV

# PTA 1,5/ 4-5,0 - PCB terminal block



1988820

<https://www.phoenixcontact.com/us/products/1988820>

minimum clearance value - non-homogenous field (II/2)	3 mm
minimum creepage distance (II/2)	3.2 mm

## Environmental and real-life conditions

### Vibration test

Specification	IEC 60068-2-6:2007-12
Frequency	10 - 150 - 10 Hz
Sweep speed	1 octave/min
Amplitude	0.35 mm (10 Hz ... 60.1 Hz)
Acceleration	5g (60.1 Hz ... 150 Hz)
Test duration per axis	2.5 h

### Glow-wire test

Specification	IEC 60695-2-10:2013-04
Temperature	850 °C
Time of exposure	5 s

### Aging

Specification	IEC 60947-7-4:2019-01
---------------	-----------------------

### Ambient conditions

Ambient temperature (operation)	-40 °C ... 105 °C (Depending on the current carrying capacity/derating curve)
Ambient temperature (storage/transport)	-40 °C ... 70 °C
Relative humidity (storage/transport)	30 % ... 70 %
Ambient temperature (assembly)	-5 °C ... 100 °C

## Packaging specifications

Type of packaging	packed in cardboard
-------------------	---------------------

# PTA 1,5/ 4-5,0 - PCB terminal block

1988820

<https://www.phoenixcontact.com/us/products/1988820>

## Drawings

Diagram

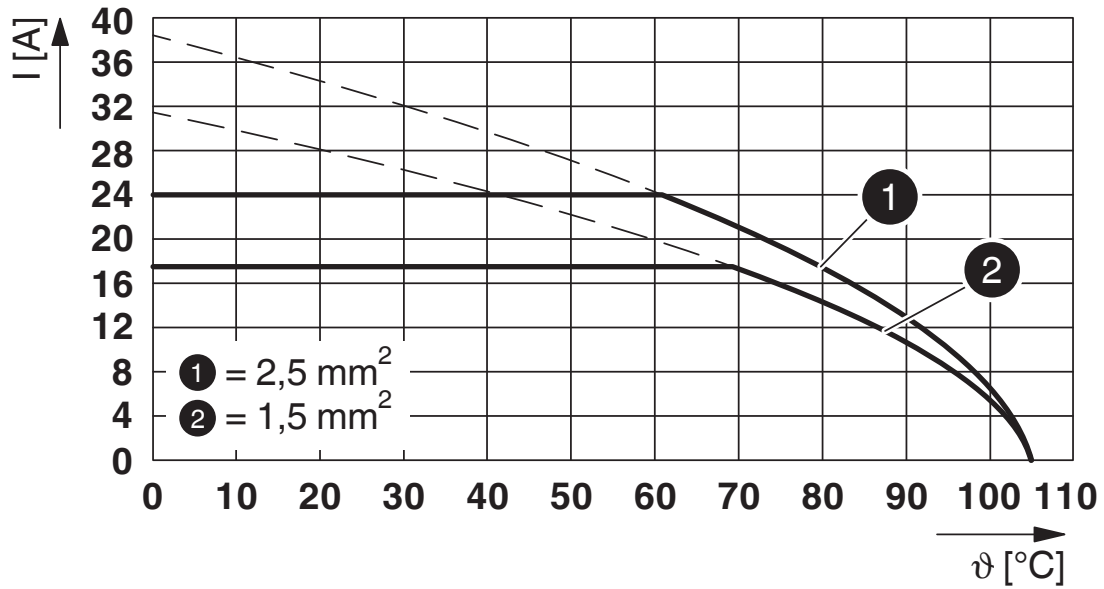

Type: PTA 1,5/...-5,0

Dimensional drawing

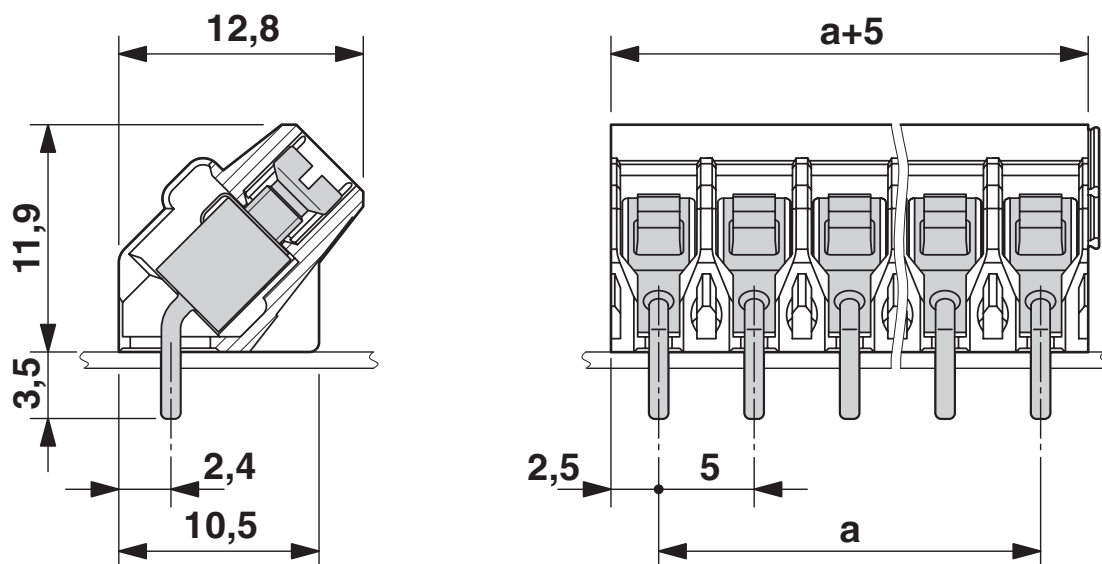

# PTA 1,5/ 4-5,0 - PCB terminal block

1988820

<https://www.phoenixcontact.com/us/products/1988820>



Drilling plan/solder pad geometry

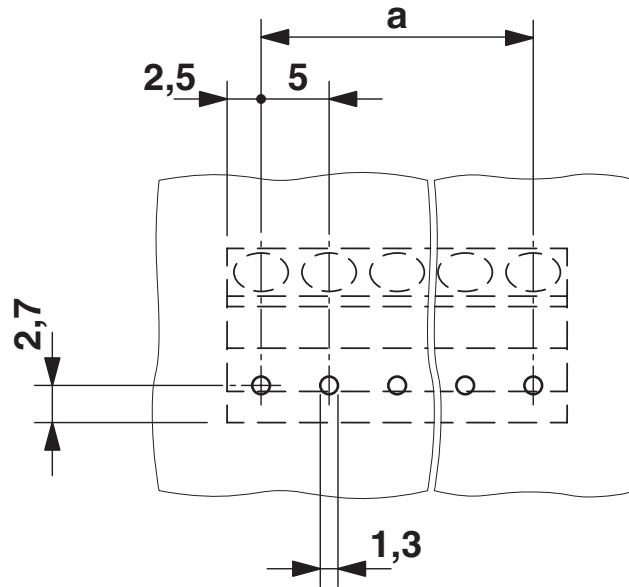

Dimensional drawing

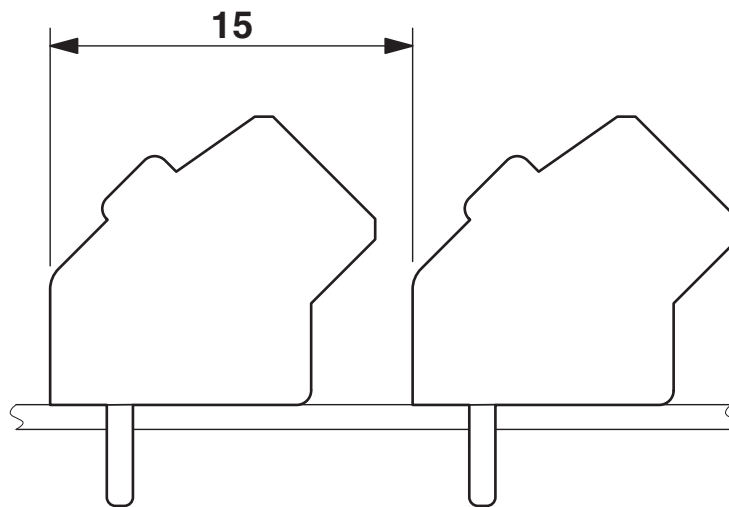

# PTA 1,5/ 4-5,0 - PCB terminal block





1988820

<https://www.phoenixcontact.com/us/products/1988820>

## Approvals

To download certificates, visit the product detail page: <https://www.phoenixcontact.com/us/products/1988820>

 <b>cULus Recognized</b> Approval ID: E60425-20030211				
	Nominal voltage $U_N$	Nominal current $I_N$	Cross section AWG	Cross section $\text{mm}^2$
Use group B	300 V	15 A	26 - 12	-
Use group D	300 V	10 A	26 - 12	-

 <b>VDE Gutachten mit Fertigungsüberwachung</b> Approval ID: 40031691				
	Nominal voltage $U_N$	Nominal current $I_N$	Cross section AWG	Cross section $\text{mm}^2$
	250 V	24 A	-	0.2 - 2.5



# PTA 1,5/ 4-5,0 - PCB terminal block



1988820

<https://www.phoenixcontact.com/us/products/1988820>

## Classifications

### ECLASS

ECLASS-11.0	27460101
ECLASS-12.0	27460101
ECLASS-13.0	27460101

### ETIM

ETIM 9.0	EC002643
----------	----------

### UNSPSC

UNSPSC 21.0	39121400
-------------	----------

# PTA 1,5/ 4-5,0 - PCB terminal block



1988820

<https://www.phoenixcontact.com/us/products/1988820>

## Environmental product compliance

### EU RoHS

Fulfills EU RoHS substance requirements	Yes
Exemption	6(c)

### China RoHS

Environment friendly use period (EFUP)	EFUP-50
	An article-related China RoHS declaration table can be found in the download area for the respective article under "Manufacturer declaration". For all articles with EFUP-E, no China RoHS declaration table issued and required.

### EU REACH SVHC

REACH candidate substance (CAS No.)	Lead(CAS: 7439-92-1)
SCIP	976235cd-7fd2-4924-9469-f14d858ef8d8

# PTA 1,5/ 4-5,0 - PCB terminal block



1988820

<https://www.phoenixcontact.com/us/products/1988820>

## Accessories

### SZS 0,6X3,5 - Screwdriver

1205053

<https://www.phoenixcontact.com/us/products/1205053>



Actuation tool, for ST terminal blocks, insulated, also suitable for use as a bladed screwdriver, size: 0.6 x 3.5 x 100 mm, 2-component grip, with non-slip grip

### SK 5/3,8:FORTL.ZAHLEN - Marker card

0804183

<https://www.phoenixcontact.com/us/products/0804183>



Marker card, white, labeled, horizontal: consecutive numbers 1 ... 10, 11 ... 20, etc. up to 91 ... (99)100, mounting type: adhesive, for terminal block width: 5 mm, lettering field size: 5 x 3.8 mm

Phoenix Contact 2024 © - all rights reserved

<https://www.phoenixcontact.com>

Phoenix Contact USA

586 Fulling Mill Road

Middletown, PA 17057, United States

(+717) 944-1300

[info@phoenixcon.com](mailto:info@phoenixcon.com)