

AC Filter 2-Stage, Very High Symmetrical and Asymmetrical Attenuation



See below:
[Approvals and Compliances](#)

Description

- Line-filter in standard version
- 2 stage
- high attenuation

Characteristics

- Designed for increased requirements
- 2-stage line filter with increased attenuation
 Protection against interference voltage from the mains
- Especially designed for industrial applications such as: Frequency Converters, Stepper Motor Drives, UPS-Systems, Inverters
 Especially suitable for use in switching power supplies
- Suitable for use in equipment according to IEC/UL 62368-1

References

Alternative: Standard version

Weblinks

[pdf data sheet](#), [html datasheet](#), [General Product Information](#), [Approvals](#), [Distributor-Stock-Check](#), [Detailed request for product](#), [Microsite](#)

Technical Data

Ratings IEC	3 - 36A @ Ta 40 °C / 250VAC; 50Hz
Ratings UL/CSA	3 - 36A @ Ta 40 °C / 125VAC; 60Hz
Leakage Current	standard < 0.5mA (250V / 60Hz)
Dielectric Strength	> 1.7kVDC between L-N > 2.7kVDC between L/N-PE Test voltage (2 sec)
Allowable Operation Temperature	-25 °C to 100 °C
Climatic Category	25/100/21 acc. to IEC 60068-1
Protection Class	Suitable for appliances with protection class I acc. to IEC 61140
Terminal	Quick connect terminals 6.3 x 0.8 mm / screw terminals Current >24 A requires screw terminals
Material: Housing	Alu. anodised / Stainless Steel

Line Filter	Standard and Industrial Version, IEC 60939, UL 1283, CSA C22.2 no. 8 Technical Details
MTBF	> 200'000h acc. to MIL-HB-217 F

Approvals and Compliances

Detailed information on product approvals, code requirements, usage instructions and detailed test conditions can be looked up in [Details about Approvals](#)

SCHURTER products are designed for use in industrial environments. They have approvals from independent testing bodies according to national and international standards. Products with specific characteristics and requirements such as required in the automotive sector according to IATF 16949, medical technology according to ISO 13485 or in the aerospace industry can be offered exclusively with customer-specific, individual agreements by SCHURTER.

Approvals



The approval mark is used by the testing authorities to certify compliance with the safety requirements placed on electronic products.

Approval Reference Type: FSW2

Approval Logo	Certificates	Certification Body	Description
	VDE Approvals	VDE	Certificate Number: 40019274
	UL Approvals	UL	UL File Number: E72928

Product standards

Product standards that are referenced

Organization	Design	Standard	Description
	Designed according to	IEC 60939	Passive filters for suppressing electromagnetic interference
	Designed according to	UL 1283	Electromagnetic interference filters
	Designed according to	CSA C22.2 no. 8	Electromagnetic interference (EMI) filters





Application standards

Application standards where the product can be used

Organization	Design	Standard	Description
	Designed for applications acc.	IEC/UL 62368-1	Audio/video, information and communication technology equipment - Part 1: Safety requirements

Compliances

The product complies with following Guide Lines

Identification	Details	Initiator	Description
	CE declaration of conformity	SCHURTER AG	The CE marking declares that the product complies with the applicable requirements laid down in the harmonisation of Community legislation on its affixing in accordance with EU Regulation 765/2008.
	RoHS	SCHURTER AG	Directive RoHS 2011/65/EU, Amendment (EU) 2015/863
	China RoHS	SCHURTER AG	The law SJ / T 11363-2006 (China RoHS) has been in force since 1 March 2007. It is similar to the EU directive RoHS.
	REACH	SCHURTER AG	On 1 June 2007, Regulation (EC) No 1907/2006 on the Registration, Evaluation, Authorization and Restriction of Chemicals 1 (abbreviated as "REACH") entered into force.

Dimension [mm]

Case 48

Case 49

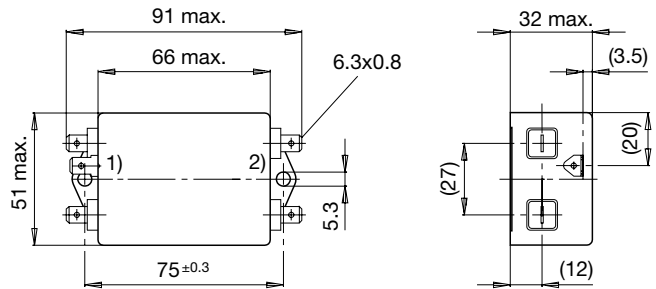
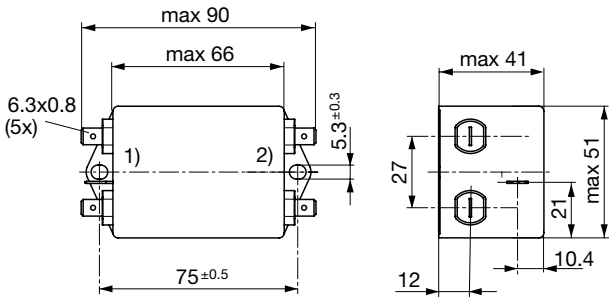

1) Line
 2) Load

1) Line
 2) Load

Case FF with bolt and nut M4

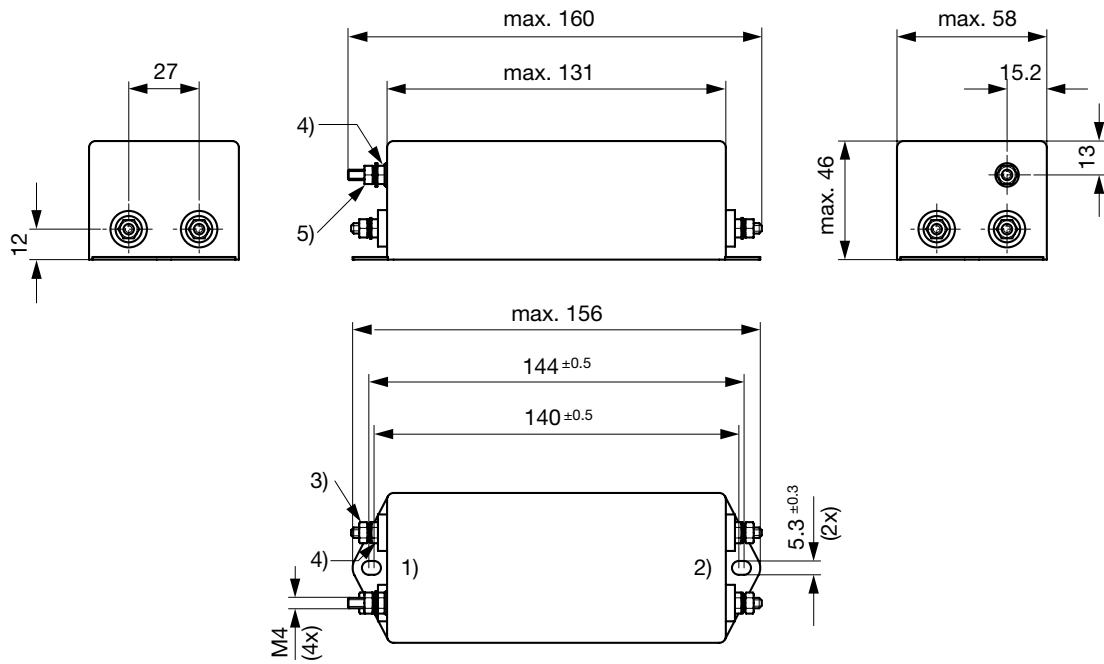

- 1) Line
- 2) Load
- 3) Lock-nut do not unscrew
- 4) Nut torque 0.85...1 Nm, keep lock-nut fastened

Case FF with quick connect terminals

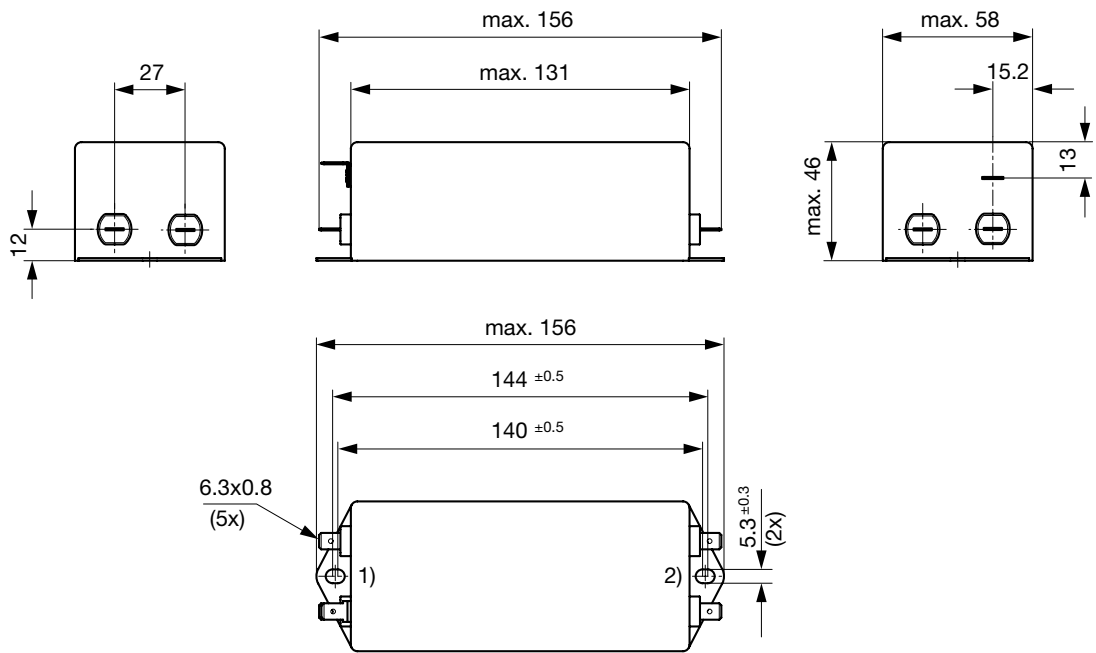

- 1) Line
- 2) Load

Diagrams

Standard version

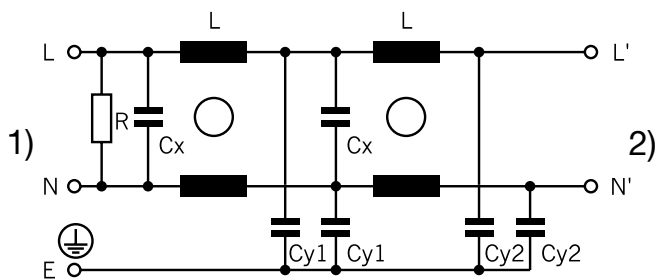

1) Line
 2) Load

Attenuation Loss

--- 50Ω differential mode ____ 50Ω common mode

Standard version

3 A

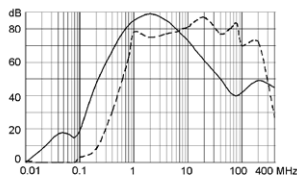

6 A

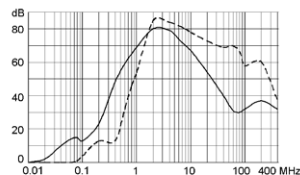

10 A

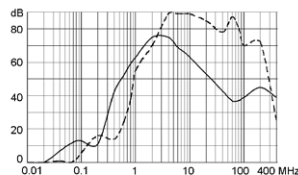

16 A

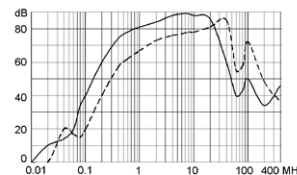

20 A

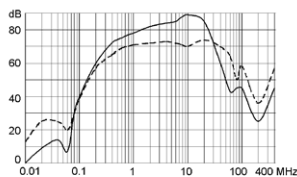

24 A

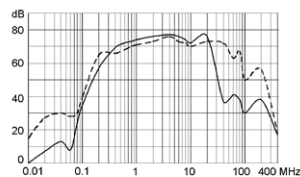

25 A

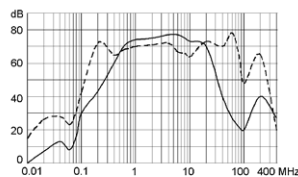

36 A

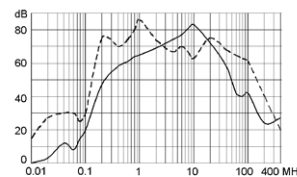

Industrial version

3 A

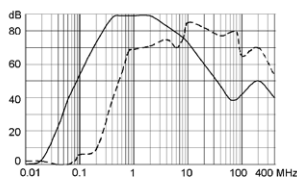

6 A

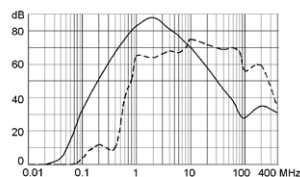

10 A

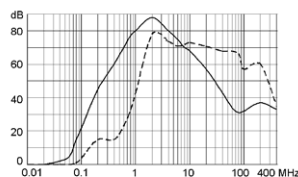

All Variants

Rated Current [A]	Filter-Type	Leakage Current [mA]	Terminal	L [mH]	Cx [μF]	Cy1 [nF]	Cy2 [nF]	R [MΩ]	Weight [g]	Housing	Packaging [PCS]	Order Number
3	Standard version	0.25	Quick connect terminals	2 x 2	0.1	1.5	1	1	157 g	49	10	5500.2058
6	Standard version	0.25	Quick connect terminals	2 x 0.8	0.1	1.5	1	1	159 g	49	10	5500.2060
10	Standard version	0.25	Quick connect terminals	2 x 0.4	0.1	1.5	1	1	159 g	49	10	5500.2062
16	Standard version	0.5	Quick connect terminals	2 x 1.3	1	4.7	-	1	200 g	48	10	5500.2218
20	Standard version	0.5	Quick connect terminals	2 x 2.4	2.2	4.7	-	1	840 g	FF	4	5500.2219
24	Standard version	0.5	Quick connect terminals	2 x 2	2.2	4.7	-	1	910 g	FF	4	5500.2220
25	Standard version	0.5	Bolts and nuts M4	2 x 2	2.2	4.7	-	1	910 g	FF	4	5500.2221
36	Standard version	0.5	Bolts and nuts M4	2 x 1.23	2.2	4.7	-	1	910 g	FF	4	5500.2222
3	Industrial version	2.5	Quick connect terminals	2 x 2	0.1	22	1	1	157 g	49	10	5500.2059
6	Industrial version	2.5	Quick connect terminals	2 x 0.8	0.1	22	1	1	159 g	49	10	5500.2061

Rated Current [A]	Filter-Type	Leakage Current [mA]	Terminal	L [mH]	Cx [μ F]	Cy1 [nF]	Cy2 [nF]	R [M Ω]	Weight [g]	Housing	Packaging [PCS]	Order Number
10	Industrial version	2.5	Quick connect terminals	2 x 0.4	0.1	22	1	1	159g	49	10	5500.2063

Most Popular.

Availability for all products can be searched real-time:<https://www.schurter.com/en/Stock-Check/Stock-Check-SCHURTER>

Mouser Electronics

Authorized Distributor

Click to View Pricing, Inventory, Delivery & Lifecycle Information:

Schurter:

[5500.2058](#) [5500.2059](#) [5500.2061](#) [5500.2062](#) [5500.2063](#) [5500.206](#) [5500.2060](#) [5500.2221](#) [5500.2218](#) [5500.2222](#)
[5500.2219](#) [5500.2220](#)