

Data Sheet | Item Number: 255-742

Stackable PCB terminal block; push-button; 2.5 mm²; Pin spacing 5/5.08 mm; 1-pole; CAGE CLAMP®; commoning option; 2,50 mm²; dark gray

<https://www.wago.com/255-742>



Color: dark gray

Similar to illustration

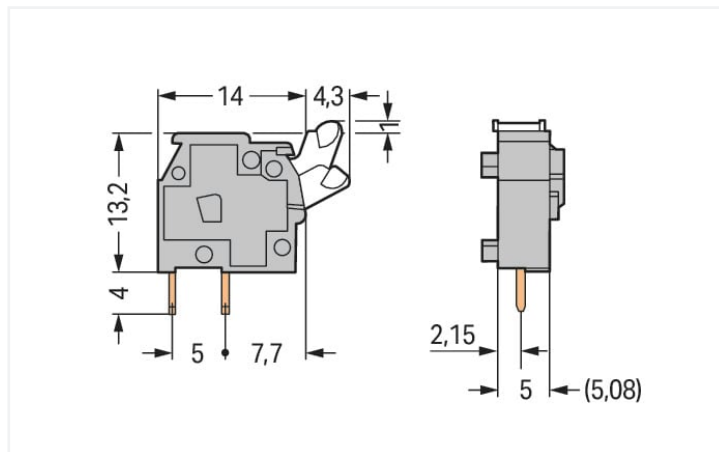

Dimensions in mm

Current-Carrying Capacity Curve
Pin spacing: 5 mm / Conductor cross-section: 2.5 mm² "f-st"
Based on: EN 60512-5-2 / Reduction factor: 1

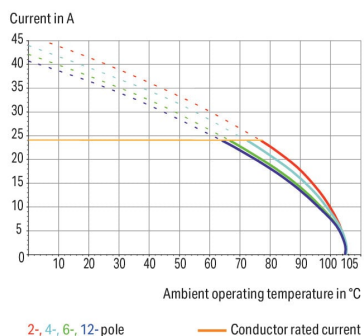

- PCB terminal blocks with push-buttons and CAGE CLAMP® connection
- Versions with Ex approval
- Set to metric or inch pin spacing by compressing PCB terminal strips or pulling them apart
- Ideal for in-the-field wiring thanks to simplified push-button actuation
- Convenient, tool-free operation

Notes

Variants:

Other colors

Versions for Ex e II and Ex i

Other versions (or variants) can be requested from WAGO Sales or configured at <https://configurator.wago.com/>.

Electrical data

Ratings per IEC/EN

Ratings per	IEC/EN 60664-1
Nominal voltage (III/3)	320 V
Rated impulse voltage (III/3)	4 kV
Rated voltage (III/2)	320 V
Rated impulse voltage (III/2)	4 kV
Nominal voltage (II/2)	630 V
Rated surge voltage (II/2)	4 kV
Rated current	24 A

Ratings per IEC/EN

Legend (ratings)	(III / 2) ≙ Overvoltage category III / Pollution degree 2
------------------	---

Ratings per UL 1059

Approvals per	UL 1059
Rated voltage UL (Use Group B)	300 V
Rated current UL (Use Group B)	15 A
Rated voltage UL (Use Group D)	300 V
Rated current UL (Use Group D)	10 A

Ratings per CSA

Approvals per	CSA
Rated voltage CSA (Use Group B)	300 V
Rated current CSA (Use Group B)	15 A
Rated voltage CSA (Use Group D)	300 V
Rated current CSA (Use Group D)	10 A

Connection data

Connection points	1
Total number of potentials	1
Number of connection types	1
Number of levels	1

Connection 1

Connection technology	CAGE CLAMP®
Actuation type	Push-button
Solid conductor	0.08 ... 2.5 mm ² / 28 ... 12 AWG
Fine-stranded conductor	0.08 ... 2.5 mm ² / 28 ... 12 AWG
Fine-stranded conductor; with insulated ferrule	0.25 ... 1.5 mm ²
Fine-stranded conductor; with uninsulated ferrule	0.25 ... 1.5 mm ²
Note (conductor cross-section)	12 AWG: THHN, THWN
Strip length	5 ... 6 mm / 0.2 ... 0.24 inches
Conductor connection direction to PCB	90°
Pole number	1

Physical data

Pin spacing	5/5.08 mm / 0.197/0.2 inches
Width	7.8 mm / 0.307 inches
Height	18.2 mm / 0.717 inches
Height from the surface	14.2 mm / 0.559 inches
Depth	18.3 mm / 0.72 inches
Solder pin length	4 mm
Solder pin dimensions	0.7 x 0.7 mm
Drilled hole diameter with tolerance	1.1 (+0.1) mm

PCB contact

PCB contact	THT
Solder pin arrangement	within the terminal block (in-line)
Number of solder pins per potential	2

Material Data

Note (material data)	Information on material specifications can be found here
Color	dark gray
Material group	I
Insulation material	Polyamide (PA66)
Flammability class per UL94	V0
Clamping spring material	Chrome-nickel spring steel (CrNi)
Contact material	Electrolytic copper (E _{Cu})
Contact plating	Tin
Fire load	0.022 MJ
Weight	1.2 g

Environmental requirements

Limit temperature range	-60 ... +105 °C
-------------------------	-----------------

Commercial data

Product Group	4 (Printed Circuit Connectors)
eCl@ss 10.0	27-44-04-01
eCl@ss 9.0	27-44-04-01
ETIM 8.0	EC002643
ETIM 7.0	EC002643
PU (SPU)	500 (100) pcs
Packaging type	Box
Country of origin	CH
GTIN	4044918662864
Customs tariff number	85369010000

Approvals / Certificates

General approvals



Approval	Standard	Certificate Name
CCA DEKRA Certification B.V.	EN 60947	2160584.40
CCA DEKRA Certification B.V.	EN 60947	NTR NL-7146
CCA DEKRA Certification B.V.	EN 60947-7-4	71-113038
CCA DEKRA Certification B.V.	IEC 60947-7-4	NTR NL-7283
UR Underwriters Laboratories Inc.	UL 1059	E45172

Approvals for marine applications



Approval	Standard	Certificate Name
ABS American Bureau of Ship- ping	-	19-HG1869876-PDA
BV Bureau Veritas S.A.	IEC 60998	11915/D0 BV
DNV GL Det Norske Veritas, Ger- manischer Lloyd	-	TAE000016Z

Downloads

Environmental Product Compliance

Compliance Search

Environmental Product
Compliance 255-742



Documentation

Additional Information			
Technical Section	03.04.2019	pdf 1949.09 KB	↓
Gebrückte Klemmenleisten für Leiterplatten		pdf 303.71 KB	↓









CAD/CAE-Data	
CAD data	CAE data
2D/3D Models 255-742 ↓	EPLAN Data Portal 255-742 ↓
	ZUKEN Portal 255-742 ↓

1 Compatible Products

1.1 Required Accessories



1.1.1 End plate

1.1.1.1 End plate

 Item No.: 255-800 End plate; snap-fit type; 1 mm thick; black	 Item No.: 255-400 End plate; snap-fit type; 1 mm thick; blue	 Item No.: 255-200 End plate; snap-fit type; 1 mm thick; dark gray	 Item No.: 255-100 End plate; snap-fit type; 1 mm thick; gray
 Item No.: 255-300 End plate; snap-fit type; 1 mm thick; light gray	 Item No.: 255-700 End plate; snap-fit type; 1 mm thick; light green	 Item No.: 255-600 End plate; snap-fit type; 1 mm thick; orange	 Item No.: 255-500 End plate; snap-fit type; 1 mm thick; red

1.1.2 Installation

1.1.2.1 Intermediate plate

 Item No.: 255-821 Spacer; for doubling the pin spacing; 10/10.16 mm thick; gray	 Item No.: 255-801 Spacer; for doubling the pin spacing; 5/5.08 mm thick; gray	 Item No.: 255-811 Spacer; for doubling the pin spacing; 7.5/7.62 mm thick; gray
--	--	---

1.2 Optional Accessories

1.2.1 Ferrule

1.2.1.1 Ferrule

 Item No.: 216-301 Ferrule; Sleeve for 0.25 mm ² / AWG 24; insulated; electro-tin plated; yellow	 Item No.: 216-321 Ferrule; Sleeve for 0.25 mm ² / AWG 24; insulated; electro-tin plated; yellow	 Item No.: 216-151 Ferrule; Sleeve for 0.25 mm ² / AWG 24; uninsulated; electro-tin plated	 Item No.: 216-131 Ferrule; Sleeve for 0.25 mm ² / AWG 24; uninsulated; electro-tin plated; silver-colored
 Item No.: 216-302 Ferrule; Sleeve for 0.34 mm ² / 22 AWG; insulated; electro-tin plated; light turquoise	 Item No.: 216-322 Ferrule; Sleeve for 0.34 mm ² / 22 AWG; insulated; electro-tin plated; light turquoise	 Item No.: 216-132 Ferrule; Sleeve for 0.34 mm ² / AWG 24; uninsulated; electro-tin plated	 Item No.: 216-152 Ferrule; Sleeve for 0.34 mm ² / AWG 24; uninsulated; electro-tin plated
 Item No.: 216-241 Ferrule; Sleeve for 0.5 mm ² / 20 AWG; insulated; electro-tin plated; electrolytic copper; gastight crimped; acc. to DIN 46228, Part 4/09.90; white	 Item No.: 216-201 Ferrule; Sleeve for 0.5 mm ² / 20 AWG; insulated; electro-tin plated; white	 Item No.: 216-221 Ferrule; Sleeve for 0.5 mm ² / 20 AWG; insulated; electro-tin plated; white	 Item No.: 216-141 Ferrule; Sleeve for 0.5 mm ² / 20 AWG; uninsulated; electro-tin plated; electrolytic copper; gastight crimped; acc. to DIN 46228, Part 1/08.92
 Item No.: 216-101 Ferrule; Sleeve for 0.5 mm ² / AWG 22; uninsulated; electro-tin plated; silver-colored	 Item No.: 216-121 Ferrule; Sleeve for 0.5 mm ² / AWG 22; uninsulated; electro-tin plated; silver-colored	 Item No.: 216-242 Ferrule; Sleeve for 0.75 mm ² / 18 AWG; insulated; electro-tin plated; electrolytic copper; gastight crimped; acc. to DIN 46228, Part 4/09.90; gray	 Item No.: 216-262 Ferrule; Sleeve for 0.75 mm ² / 18 AWG; insulated; electro-tin plated; electrolytic copper; gastight crimped; acc. to DIN 46228, Part 4/09.90; gray
 Item No.: 216-202 Ferrule; Sleeve for 0.75 mm ² / 18 AWG; insulated; electro-tin plated; gray	 Item No.: 216-222 Ferrule; Sleeve for 0.75 mm ² / 18 AWG; insulated; electro-tin plated; gray	 Item No.: 216-142 Ferrule; Sleeve for 0.75 mm ² / 18 AWG; uninsulated; electro-tin plated; electrolytic copper; gastight crimped; acc. to DIN 46228, Part 1/08.92	 Item No.: 216-102 Ferrule; Sleeve for 0.75 mm ² / AWG 20; uninsulated; electro-tin plated; silver-colored
 Item No.: 216-122 Ferrule; Sleeve for 0.75 mm ² / AWG 20; uninsulated; electro-tin plated; silver-colored	 Item No.: 216-243 Ferrule; Sleeve for 1 mm ² / AWG 18; insulated; electro-tin plated; electrolytic copper; gastight crimped; acc. to DIN 46228, Part 4/09.90; red	 Item No.: 216-263 Ferrule; Sleeve for 1 mm ² / AWG 18; insulated; electro-tin plated; electrolytic copper; gastight crimped; acc. to DIN 46228, Part 4/09.90; red	 Item No.: 216-203 Ferrule; Sleeve for 1 mm ² / AWG 18; insulated; electro-tin plated; red
 Item No.: 216-223 Ferrule; Sleeve for 1 mm ² / AWG 18; insulated; electro-tin plated; red	 Item No.: 216-103 Ferrule; Sleeve for 1 mm ² / AWG 18; uninsulated; electro-tin plated	 Item No.: 216-143 Ferrule; Sleeve for 1 mm ² / AWG 18; uninsulated; electro-tin plated; electrolytic copper; gastight crimped; acc. to DIN 46228, Part 1/08.92	 Item No.: 216-123 Ferrule; Sleeve for 1 mm ² / AWG 18; uninsulated; electro-tin plated; silver-colored
 Item No.: 216-204 Ferrule; Sleeve for 1.5 mm ² / AWG 16; insulated; electro-tin plated; black	 Item No.: 216-224 Ferrule; Sleeve for 1.5 mm ² / AWG 16; insulated; electro-tin plated; black	 Item No.: 216-244 Ferrule; Sleeve for 1.5 mm ² / AWG 16; insulated; electro-tin plated; electrolytic copper; gastight crimped; acc. to DIN 46228, Part 4/09.90; black	 Item No.: 216-264 Ferrule; Sleeve for 1.5 mm ² / AWG 16; insulated; electro-tin plated; electrolytic copper; gastight crimped; acc. to DIN 46228, Part 4/09.90; black
 Item No.: 216-284 Ferrule; Sleeve for 1.5 mm ² / AWG 16; insulated; electro-tin plated; electrolytic copper; gastight crimped; acc. to DIN 46228, Part 4/09.90; black	 Item No.: 216-124 Ferrule; Sleeve for 1.5 mm ² / AWG 16; uninsulated; electro-tin plated	 Item No.: 216-144 Ferrule; Sleeve for 1.5 mm ² / AWG 16; uninsulated; electro-tin plated; electrolytic copper; gastight crimped; acc. to DIN 46228, Part 1/08.92; silver-colored	 Item No.: 216-104 Ferrule; Sleeve for 1.5 mm ² / AWG 16; uninsulated; electro-tin plated; silver-colored

1.2.2 Marking

1.2.2.1 Marking strip



Item No.: 210-833
 Marking strips; 25 m on roll; 6 mm wide; plain; Self-adhesive; white

Item No.: 210-332/500-202
 Marking strips; as a DIN A4 sheet; MARKED; 1-16 (160x); Height of marker strip: 3 mm; Strip length 182 mm; Horizontal marking; Self-adhesive; white

Item No.: 210-332/508-202
 Marking strips; as a DIN A4 sheet; MARKED; 1-16 (160x); Height of marker strip: 3 mm; Strip length 182 mm; Horizontal marking; Self-adhesive; white

Item No.: 210-332/500-205
 Marking strips; as a DIN A4 sheet; MARKED; 1-32 (80x); Height of marker strip: 3 mm; Strip length 182 mm; Horizontal marking; Self-adhesive; white



Item No.: 210-332/508-205
 Marking strips; as a DIN A4 sheet; MARKED; 1-32 (80x); Height of marker strip: 3 mm; Strip length 182 mm; Horizontal marking; Self-adhesive; white

Item No.: 210-332/500-204
 Marking strips; as a DIN A4 sheet; MARKED; 17-32 (160x); Height of marker strip: 3 mm; Strip length 182 mm; Horizontal marking; Self-adhesive; white

Item No.: 210-332/508-204
 Marking strips; as a DIN A4 sheet; MARKED; 17-32 (160x); Height of marker strip: 3 mm; Strip length 182 mm; Horizontal marking; Self-adhesive; white

Item No.: 210-332/500-206
 Marking strips; as a DIN A4 sheet; MARKED; 33-48 (160x); Height of marker strip: 3 mm; Strip length 182 mm; Horizontal marking; Self-adhesive; white



Item No.: 210-332/508-206
 Marking strips; as a DIN A4 sheet; MARKED; 33-48 (160x); Height of marker strip: 3 mm; Strip length 182 mm; Horizontal marking; Self-adhesive; white

1.2.3 Test and measurement

1.2.3.1 Testing accessories



Item No.: 249-110
 Test plug adapter; suitable for 255, 256, 257 Series PCB terminal blocks; 1-pole; Pin spacing 5 mm / 0.197 in; gray

Item No.: 249-111
 Test plug adapter; suitable for 255, 256, 257 Series PCB terminal blocks; 1-pole; Pin spacing 5.08 mm / 0.2 in; orange

1.2.4 Tool

1.2.4.1 Operating tool



Item No.: 210-658
 Operating tool; Blade: 3.5 x 0.5 mm; with a partially insulated shaft; angled; short; multicoloured

Item No.: 210-720
 Operating tool; Blade: 3.5 x 0.5 mm; with a partially insulated shaft; multicoloured

Installation Notes

Conductor termination

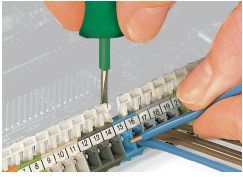

Inserting/removing a conductor – 256 Series.

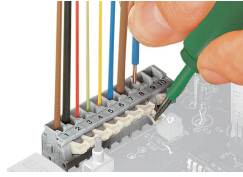

Inserting/removing a conductor (255 Series)

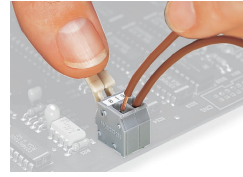

Inserting/removing a conductor via finger-operated lever – 255 Series.

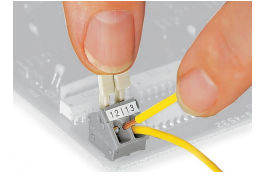

Inserting/removing a conductor via finger-operated lever – 256 Series.

Installation



Possible conductor arrangement with terminal strips staggered (for 256 Series only).

Marking

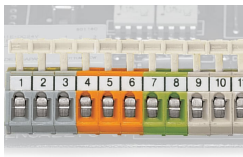

Formation of groups using housings of different colors

Testing

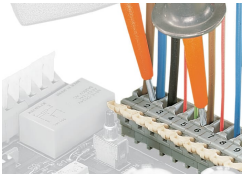

Testing with test probes.



Testing with test plug modules.