

5

4

3

2

1

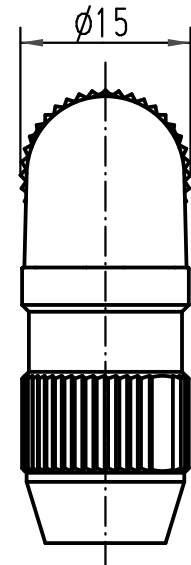
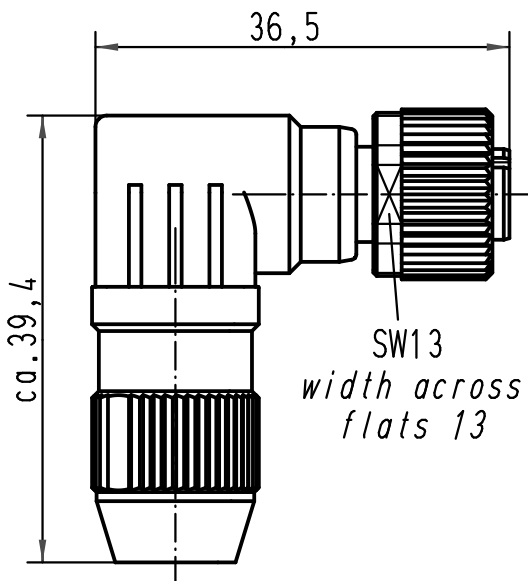
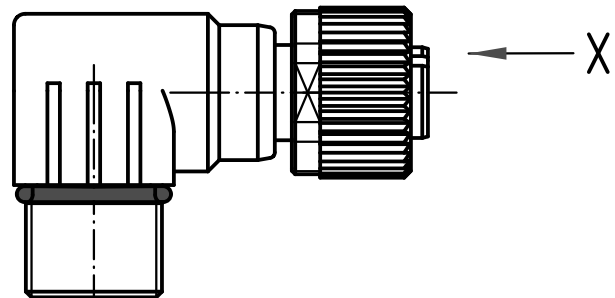

Steckgesicht n.  
Contact face acc.  
IEC 61076-2-101

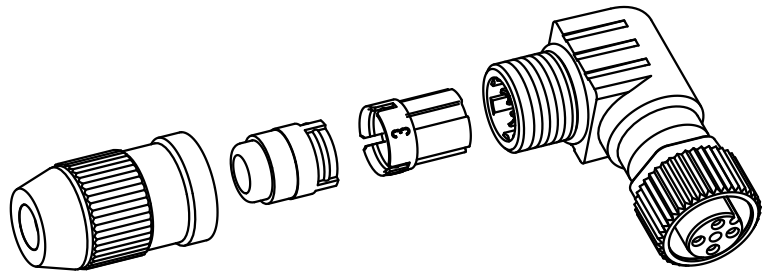
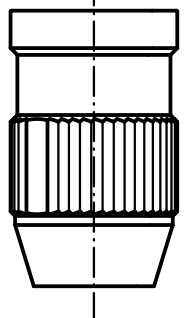
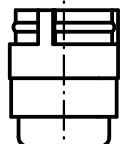
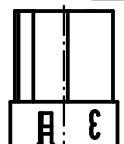
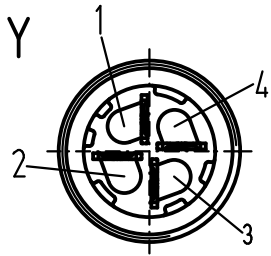
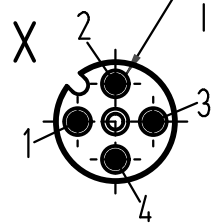

All Dimensions in mm Original Size DIN A 4			Techn. Character.			Nicht tolerierte Maße/Free size tolerances			
				Dat.	Name	Maßstab/ Scale  %	<b>Rundsteckverbinder/ Circular connector</b> M12 gewinkelt 4polig Buchse M12 angled 4poles female		
			Detail.	17.05.00	Pae				
			Insp.		Weil				
			Stand.						
412985	12.06.07	DY	HARTING Electric GmbH & Co. KG D-32339 Espelkamp				<b>TB 21 01 140 5091</b>		
411054	26.05.04	DY							
27837									
Mod.	Dat.	Name				Sub.TB 2109 003 03 02			

Blatt/ page

D  
C  
B  
A