

KAM10 SERIES

AC - DC POWER MODULE
10W SINGLE & DUAL OUTPUT



FEATURES

- AC/DC POWER MODULE
- UNIVERSAL INPUT 85 ~ 265 VAC
- HIGH EFFICIENCY UP TO 78%
- SHORT CIRCUIT PROTECTION
- INTERNAL INPUT FILTER
- 3 YEARS WARRANTY



MODEL LIST

MODEL NO.	INPUT VOLTAGE	OUTPUT WATTAGE	OUTPUT VOLTAGE	OUTPUT CURRENT	EFF. (min.)	EFF. (typ.)	CAPACITOR LOAD (max.)
-----------	---------------	----------------	----------------	----------------	-------------	-------------	-----------------------

Single Output Models

KAM1003	85~265 VAC	10 WATTS	+3.3 VDC	3000 mA	67%	70%	7000 μ F
KAM1005	85~265 VAC	10 WATTS	+ 5 VDC	2000 mA	70%	72%	7000 μ F
KAM1012	85~265 VAC	10 WATTS	+ 12 VDC	840 mA	75%	77%	3500 μ F
KAM1015	85~265 VAC	10 WATTS	+ 15 VDC	670 mA	75%	77%	1500 μ F
KAM1024	85~265 VAC	10 WATTS	+ 24 VDC	420 mA	76%	78%	470 μ F

Dual Output Models

KAM1012D	85~265 VAC	10 WATTS	\pm 12 VDC	\pm 420 mA	75%	77%	\pm 1000 μ F
KAM1015D	85~265 VAC	10 WATTS	\pm 15 VDC	\pm 335 mA	74%	77%	\pm 470 μ F
KAM10503D	85~265 VAC	10 WATTS	+ 5 / + 3.3 VDC	+0.8 / +2A	72%	74%	3500 μ F

SPECIFICATION

All Specifications Typical At Nominal Line, Full Load, 25°C Unless Otherwise Noticed

GENERAL						
Characteristics	Conditions	min.	typ.	max.	unit	
Switching frequency	V_i nom, I_o nom		100		KHz	
Isolation voltage	Input - Output	3,000/4,242			VAC/VDC	
Isolation resistance	Input - Output, @ 500VDC	100			M Ω	
Ambient temperature	Operating at V_i nom, I_o nom	-40		+ 71	$^{\circ}$ C	
Case temperature	Operating at V_i nom, I_o nom			+ 85	$^{\circ}$ C	
Derating	V_i nom, +5 l to + 71 $^{\circ}$ C			2	% / $^{\circ}$ C	
Storage temperature	Non operational	-40		+ 100	$^{\circ}$ C	
Relative humidity	V_i nom, I_o nom	20		95	% RH	
Temperature coefficient	V_i nom, I_o min			\pm 0.03	% / $^{\circ}$ C	

SPECIFICATION

All Specifications Typical At Nominal Line, Full Load, 25°C Unless Otherwise Noticed

GENERAL

Characteristics	Conditions	min.	typ.	max.	unit
MTBF	Bellcore issue 6 @40°C, GB	3.3V, 5V & 503D		1,300,000	Hours
		12V & 15V		1,340,000	Hours
		24V, 12D & 15D		1,380,000	Hours
Altitude during operation	IEC 60068-2-13			4,850	m
Dimension		L76.2 x W50.8 x H22.8			mm
Cooling	Free air convection				

INPUT SPECIFICATIONS

Characteristics	Conditions	min.	typ.	max.	unit
Rated input voltage	lo nom	85		265	VAC
Input voltage range	Ta min ... Ta max, lo nom	AC in	85	265	VAC
		DC in	120	375	VDC
Input current	Vi : 115 / 230 VAC, lo nom		230 / 150		mA
Rated input current	Vi : 85 VAC, lo nom			350	mA
Line frequency	Vi nom, lo nom	47		63	Hz
Inrush current	Vi : 115 / 230 VAC, lo nom			10/18	A
Leakage current	Input - Output			0.25	mA

OUTPUT SPECIFICATIONS

Characteristics	Conditions	min.	typ.	max.	unit
Output voltage accuracy	Vi nom, lo nom			± 2	%
Minimum load	Vi nom	single output models	0		%
		dual output models (each output)	20		%
Line regulation	lo nom, Vi min ... Vi max			± 1	%
Load regulation	Vi nom, lo min ... lo nom	single output models		± 2	%
		dual output models		± 2	%
Cross regulation	Asymmetrical load 20% - 100% FL			± 6	%
Hold up time	Vi 115/230 VAC, lo nom	15/30			ms
Turn on time	Vi nom, lo nom			1,000	ms
Rise time	Vi nom, lo nom			150	ms
Fall time	Vi nom, lo nom			150	ms
Transient recovery time	Vi nom, I ~ 0.5 lo nom			1	ms
Ripple & noise	Vi nom, lo nom BW = 20MHz	3.3V & 5V		100	mV
		12V, 15V, 24V & dual		150	mV
External trim ADJ. Range 1) (for single output only)	lo = 5% ... 100%	- 10		+ 10	%
Efficiency	Vi nom, lo nom, Po / Pi	Up to 78%, See model list and typ efficiency curve			

NOTE 1 : Pls refer to Fig 1 & Table 1 for connection and resistance recommended.

CONTROL AND PROTECTION

Characteristics	Conditions	min.	typ.	max.	unit
Input fuse		T2A / 250VAC internal			
Internal surge voltage protection	IEC 61000-4-5	Varistor			
Output short circuit		Hiccup mode			

SPECIFICATION

All Specifications Typical At Nominal Line, Full Load, 25°C Unless Otherwise Noticed

APPROVALS AND STANDARDS

UL / cUL	UL 60950-1, Recognized
TUV	EN 60950-1
CE	EN 61000-6-3, EN 55032 Class B, EN 61000-3-2, EN 61000-3-3 EN 61000-6-2, EN 55024, EN 61000-4-2, EN 61000-4-3 EN 61000-4-4, EN 61000-4-5, EN 61000-4-6, EN 61000-4-8 EN 61000-4-11, EN 61204-3
Vibration resistance	meet IEC 60068-2-6 (10-500 Hz, 2G, along X, Y, Z each Axis, 60 min for each Axis)
Shock resistance	meet IEC 60068-2-27 (15G, 11ms, 3 axes, 6 Faces, 3 times for each Face)

PHYSICAL CHARACTERISTICS

Case size	76.2 x 50.8 x 22.8mm (3 x 2 x 0.90 inches)
Case material	Plastic
Weight	160g
Potting material	Epoxy

MECHANISM & PIN CONFIGURATION

mm [inch]

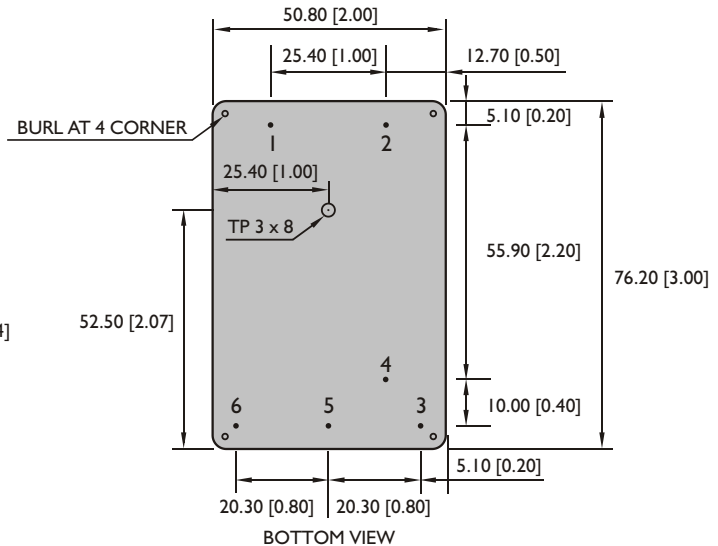
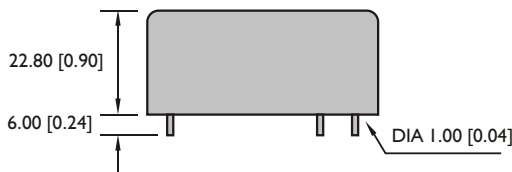

GENERAL TOLERANCE	
0.00[0.00] - 30.00[1.18]	±0.30[0.01]
30.00[1.18] - 120.00[4.72]	±0.50[0.02]

PIN ASSIGNMENT

GENERAL

PIN NO.	1	2	3	4	5	6
SINGLE	AC IN	AC IN	Vo -	Trim	NO PIN	Vo +
DUAL 12D, 15D	AC IN	AC IN	Vo -	NO PIN	com	Vo +
503D	AC IN	AC IN	+3.3V	NO PIN	com	+5V

CIRCUIT SCHEMATIC

• Block diagram for KAM10 series with single output

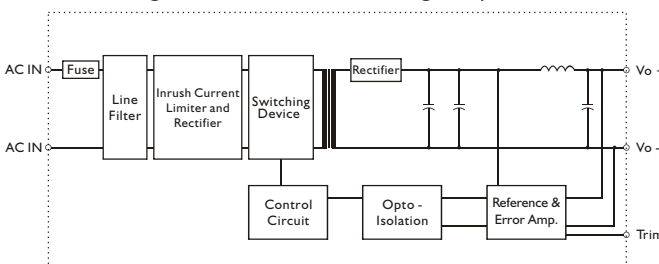

• Block diagram for KAM10 series with dual output

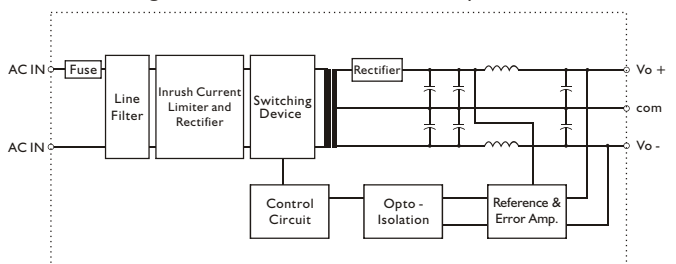

CIRCUIT SCHEMATIC

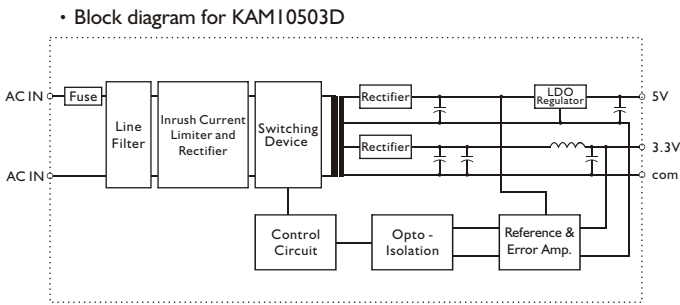

TYP. CURRENT LIMITED CURVE

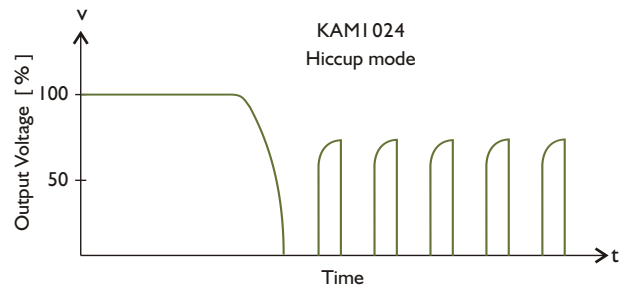

DERATING CURVE

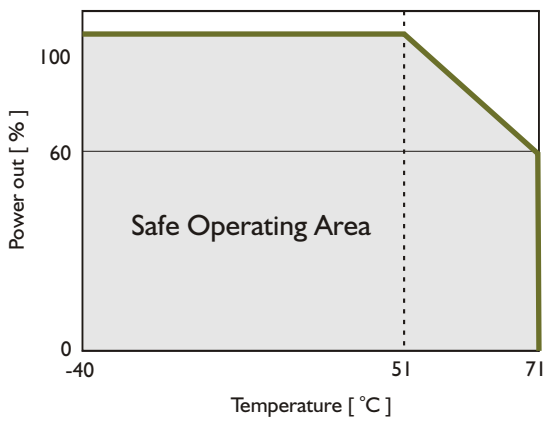

TYP. EFFICIENCY CURVE

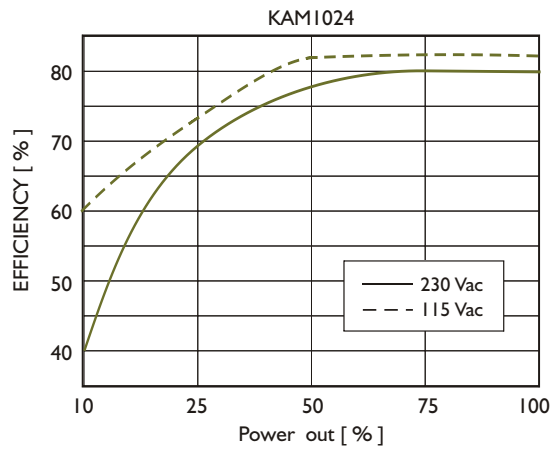

Fig. 1 Trim connection (For single output only)

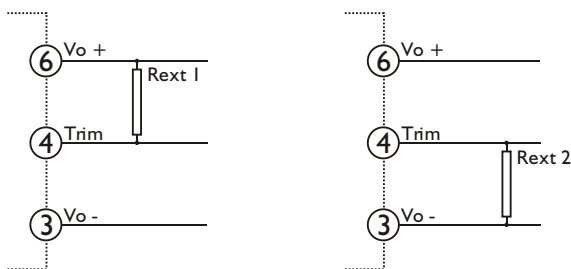

Table 1 Typical resistor values for various output voltage adjustment settings and max continuous power

Type	Rext 1		Rext 2		Max continuous power
	Vo nom -5%	Vo nom -10%	Vo nom +5%	Vo nom +10%	
KAM1003	180KΩ	56KΩ	100KΩ	20KΩ	10W
KAM1005	39KΩ	15KΩ	9.1KΩ	2.2KΩ	10W
KAM1012	51KΩ	20KΩ	10KΩ	2KΩ	10W
KAM1015	150KΩ	68KΩ	20KΩ	4.7KΩ	10W
KAM1024	130KΩ	56KΩ	12KΩ	2KΩ	10W