

Printed-circuit board connector - MVSTBR 2,5/10-STF-5,08 - 1835177

Please be informed that the data shown in this PDF Document is generated from our Online Catalog. Please find the complete data in the user's documentation. Our General Terms of Use for Downloads are valid (<http://phoenixcontact.com/download>)



PCB connector, nominal current: 12 A, rated voltage (III/2): 320 V, nominal cross section: 2.5 mm², number of positions: 10, pitch: 5.08 mm, connection method: Screw connection with tension sleeve, color: green, contact surface: Tin

The figure shows a 10-position version of the product

Your advantages

- ✓ Well-known connection principle allows worldwide use
- ✓ Screwable flange for superior mechanical stability
- ✓ Low temperature rise, thanks to maximum contact force
- ✓ Allows connection of two conductors



Key Commercial Data

Packing unit	50 pc
GTIN	 4 017918 103361
GTIN	4017918103361

Technical data

Item properties

Brief article description	Printed-circuit board connector
Plug-in system	CLASSIC COMBICON
Type of contact	Female connector
Range of articles	MVSTBR 2,5/...-STF
Pitch	5.08 mm
Number of positions	10
Connection method	Screw connection with tension sleeve
Drive form screw head	Slotted (L)
Screw thread	M3
Locking	Screw flange
Number of levels	1

Printed-circuit board connector - MVSTBR 2,5/10-STF-5,08 - 1835177

Technical data

Item properties

Number of connections	10
Number of potentials	10

Electrical parameters

Nominal current	12 A
Nom. voltage	320 V
Rated voltage	250 V
Rated voltage (III/2)	320 V
Rated voltage (II/2)	630 V
Rated surge voltage (III/3)	4 kV
Rated surge voltage (III/2)	4 kV
Rated surge voltage (II/2)	4 kV

Connection capacity

Connection method	Screw connection with tension sleeve
pluggable	Yes
Conductor cross section solid	0.2 mm ² ... 2.5 mm ²
Conductor cross section flexible	0.2 mm ² ... 2.5 mm ²
Conductor cross section AWG / kcmil	24 ... 12
Conductor cross section flexible, with ferrule without plastic sleeve	0.25 mm ² ... 2.5 mm ²
Conductor cross section, flexible, with ferrule, with plastic sleeve	0.25 mm ² ... 2.5 mm ²
2 conductors with same cross section, solid	0.2 mm ² ... 1 mm ²
2 conductors with same cross section, flexible	0.2 mm ² ... 1.5 mm ²
2 conductors with same cross section, flexible, with ferrule without plastic sleeve	0.25 mm ² ... 1 mm ²
2 conductors with the same cross section, flexible, with TWIN ferrule with plastic sleeve	0.5 mm ² ... 1.5 mm ²
Cylindrical gauge a x b / diameter	2.8 mm x 2.0 mm / 2.4 mm
Stripping length	7 mm
Torque	0.5 Nm ... 0.6 Nm

Flange specifications

Type of locking	Screw locking
Mounting flange	Screw flange
Torque	0.3 Nm

Material data - contact

Note	WEEE/RoHS-compliant, free of whiskers according to IEC 60068-2-82/ JEDEC JESD 201
Contact material	Cu alloy
Surface characteristics	hot-dip tin-plated
Metal surface terminal point (top layer)	Tin (4 - 8 µm Sn)
Metal surface contact area (top layer)	Tin (4 - 8 µm Sn)

Material data - housing

Printed-circuit board connector - MVSTBR 2,5/10-STF-5,08 - 1835177

Technical data

Material data - housing

Housing color	green (6021)
Insulating material	PA
Insulating material group	I
CTI according to IEC 60112	600
Flammability rating according to UL 94	V0

Dimensions for the product

Length [l]	12.6 mm
Width [w]	60.96 mm
Height [h]	26 mm
Pitch	5.08 mm
Height (without solder pin)	26 mm

Packaging information

Type of packaging	packed in cardboard
Pieces per package	50
Denomination packing units	Pcs.

Ambient conditions

Ambient temperature (storage/transport)	-40 °C ... 70 °C
Ambient temperature (assembly)	-5 °C ... 100 °C
Ambient temperature (operation)	-40 °C ... 100 °C (dependent on the derating curve)

Termination and connection method

Test for conductor damage and slackening	IEC 60999-1:1999-11
	Test passed

Pull-out test

Pull-out test	IEC 60999-1:1999-11
	Test passed
Conductor cross section / conductor type / tensile force	0.2 mm ² / solid / > 10 N
	0.2 mm ² / flexible / > 10 N
	2.5 mm ² / solid / > 50 N
	2.5 mm ² / flexible / > 50 N

Mechanical tests according to standard

Test specification	IEC 61984
Visual inspection	IEC 60512-1-1:2002-02
Dimension check	IEC 60512-1-2:2002-02
Resistance of inscriptions	IEC 60068-2-70:1995-12
Insertion and withdrawal force	IEC 60512-13-2:2006-02
No. of cycles	25
Insertion strength per pos. approx.	8 N
Withdraw strength per pos. approx.	6 N

Printed-circuit board connector - MVSTBR 2,5/10-STF-5,08 - 1835177

Technical data

Mechanical tests according to standard

Polarization and coding	IEC 60512-13-5:2006-02
Contact holder in insert	IEC 60512-15-1:2008-05
Test force per pos.	38 N

Air clearances and creepage distances

Clearances and creepage distances	IEC 60664-1:2007-04
Specification	IEC 60664-1:2007-04
Minimum clearance - inhomogeneous field (III/3)	3 mm
Minimum clearance - inhomogeneous field (III/2)	3 mm
Minimum clearance - inhomogeneous field (II/2)	3 mm
Minimum creepage distance value (III/3)	3.2 mm
Minimum creepage distance value (III/2)	3 mm
Minimum creepage distance value (II/2)	3.2 mm

Current carrying capacity / derating curves

Caption	Type: MVSTBR 2,5/...-STF-5,08 with MSTB 2,5/...-GF-5,08
Specification	IEC 61984:2008-10
Reduction factor	0.8
Note	Representation based on IEC 60512-5-2:2002-02
	For number of positions, see diagram

Mechanical tests (A)

Test specification	IEC 61984
Insertion strength per pos. approx.	8 N
Withdraw strength per pos. approx.	6 N
Polarization when inserted requirement >20 N	Test passed
Contact holder in insert requirements >20 N	Test passed

Durability tests (B)

Specification	IEC 60512-9-1:2010-03
Contact resistance R ₁	2.4 mΩ
Insertion/withdrawal cycles	25
Contact resistance R ₂	2.4 mΩ
Impulse withstand voltage at sea level	4.8 kV
Power-frequency withstand voltage	2.21 kV
Insulation resistance, neighboring positions	> 75 TΩ

Thermal tests (C)

Specification	IEC 60512-5-1:2002-02
Number of positions	24
Conductor cross section	2.5 mm ²
Test current	12 A DC
Upper limiting temperature requirements <100 °C	Test passed

Printed-circuit board connector - MVSTBR 2,5/10-STF-5,08 - 1835177

Technical data

Climatic tests (D)

Specification	ISO 6988:1985-02
Cold stress	-40 °C/2 h
Thermal stress	100 °C/168 h
Corrosive stress	0.2 dm ³ SO ₂ on 300 dm ³ /40 °C/1 cycle
Impulse withstand voltage at sea level	4.8 kV
Power-frequency withstand voltage	2.21 kV

Environmental and durability tests (E)

Specification	IEC 61984:2008-10
Result, degree of protection, IP code	Finger safety with IP20 test finger

Environmental Product Compliance

REACH SVHC	Lead 7439-92-1
China RoHS	Environmentally Friendly Use Period = 50 years
	For details about hazardous substances go to tab "Downloads", Category "Manufacturer's declaration"

Drawings

Diagram

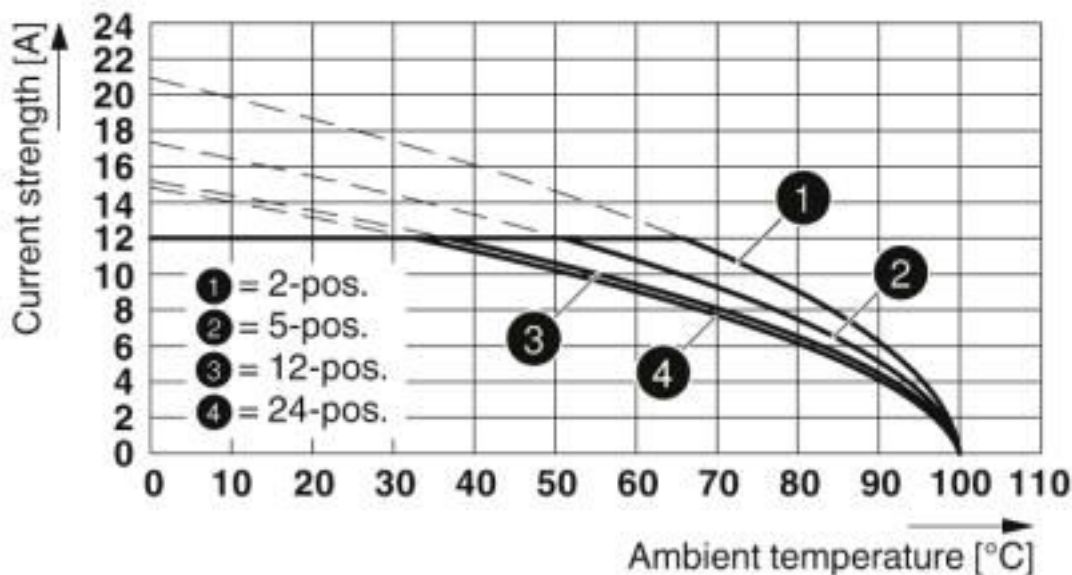

Type: MVSTBR 2,5/...-STF-5,08 with MSTB 2,5/...-GF-5,08

Printed-circuit board connector - MVSTBR 2,5/10-STF-5,08 - 1835177

Diagram

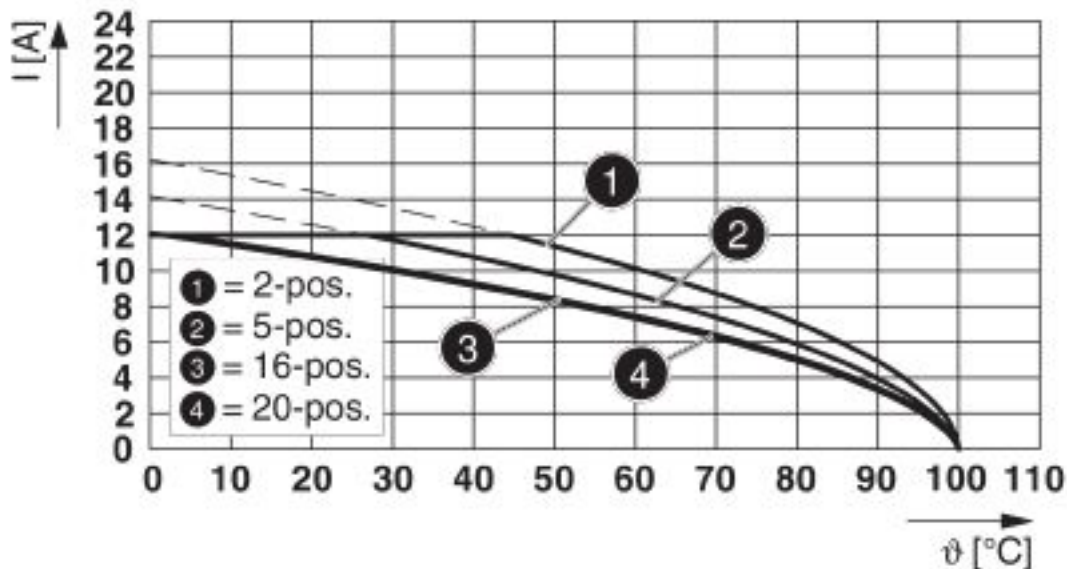

Type: MVSTB(R/W) 2,5/...-STF-5,08 with MSTBV 2,5/...-GF-5,08

Diagram

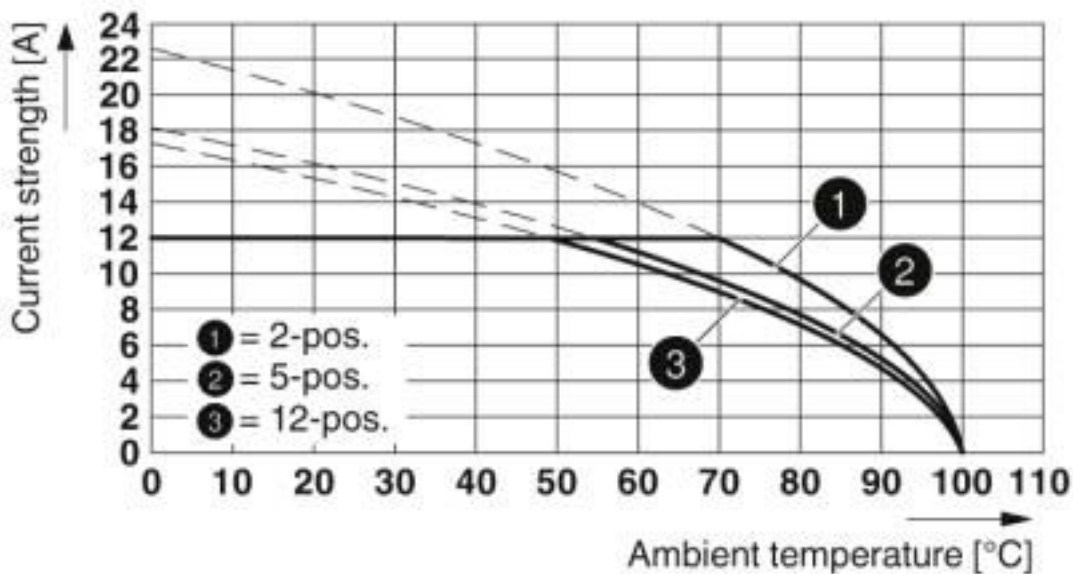

Type: MVSTB(R/W) 2,5/...-STF-5,08 with CC 2,5/...-GF-5,08 P26THR

Printed-circuit board connector - MVSTBR 2,5/10-STF-5,08 - 1835177

Diagram

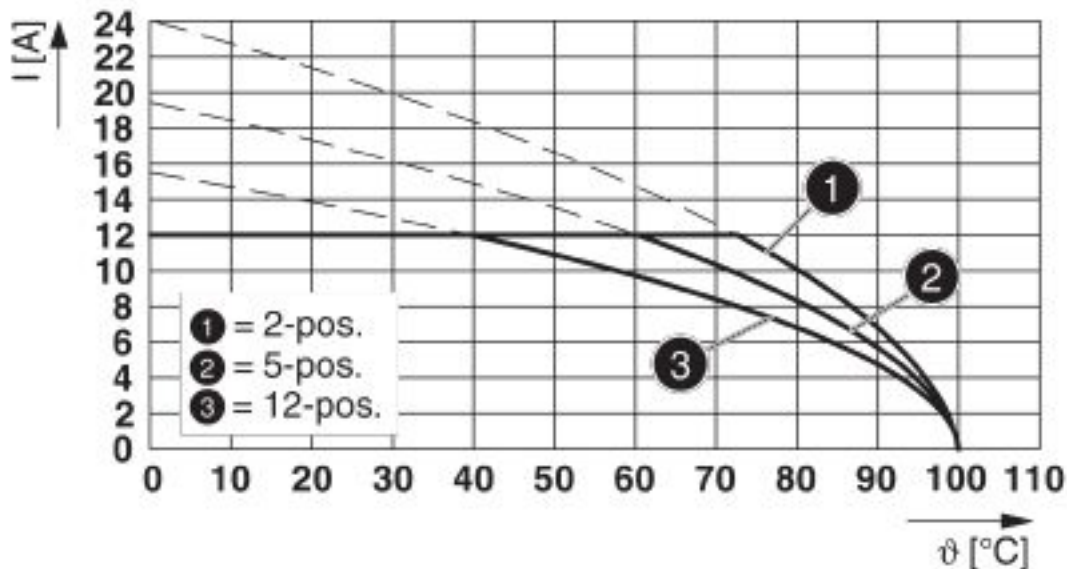

Type: MVSTB(R/W) 2,5/...-STF-5,08 with CC 2,5/...-GF-5,08-LR P...THR

Diagram

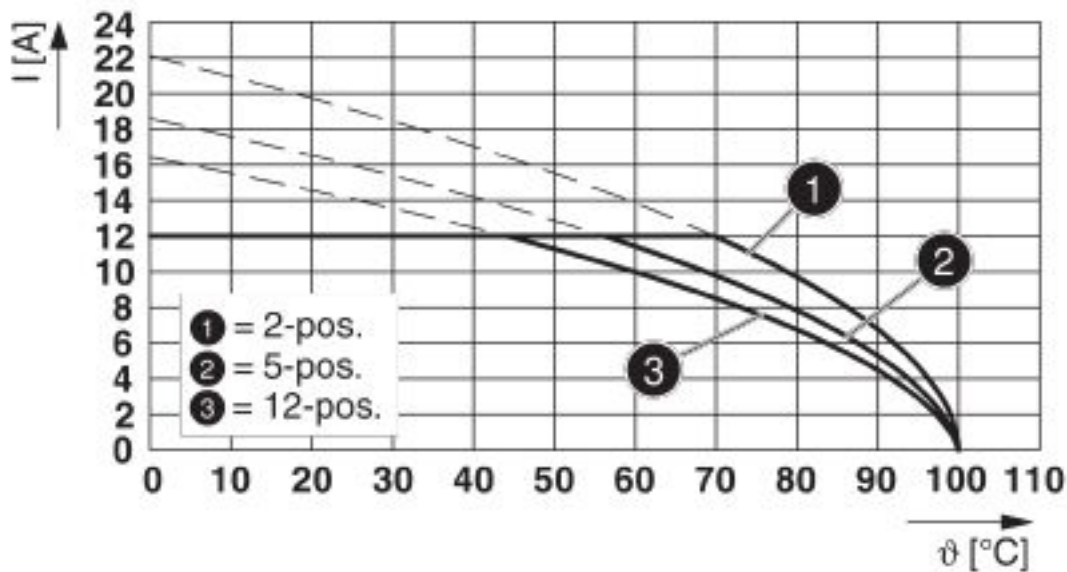

Type: MVSTB(R/W) 2,5/...-STF-5,08 with CCV 2,5/...-GF-5,08-LR P...THR

Printed-circuit board connector - MVSTBR 2,5/10-STF-5,08 - 1835177

Diagram

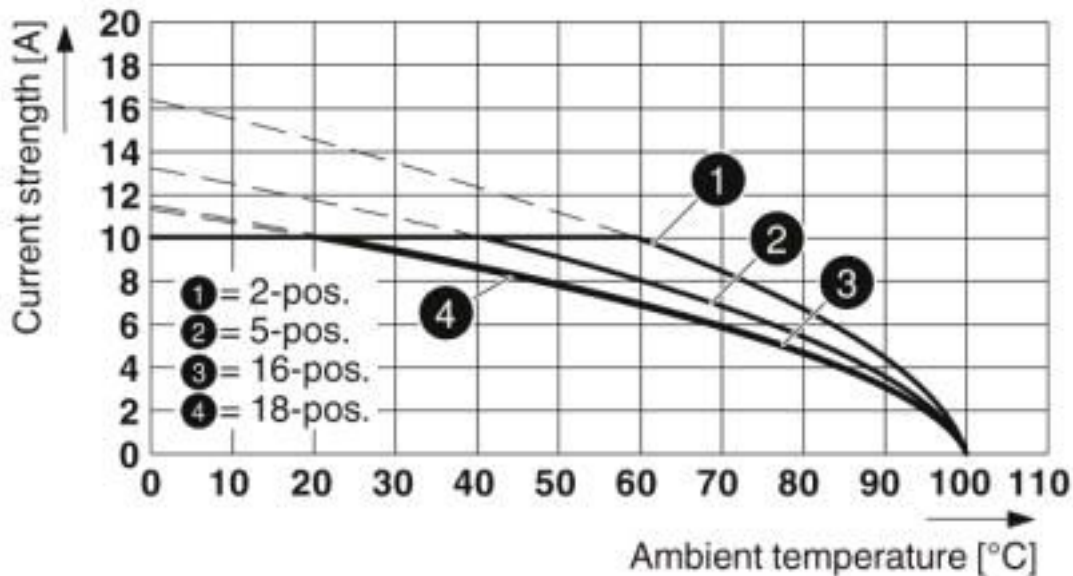

Type: MVSTB(R/W) 2,5/...-STF-5,08 with MDSTBV 2,5/...-GF-5,08

Diagram

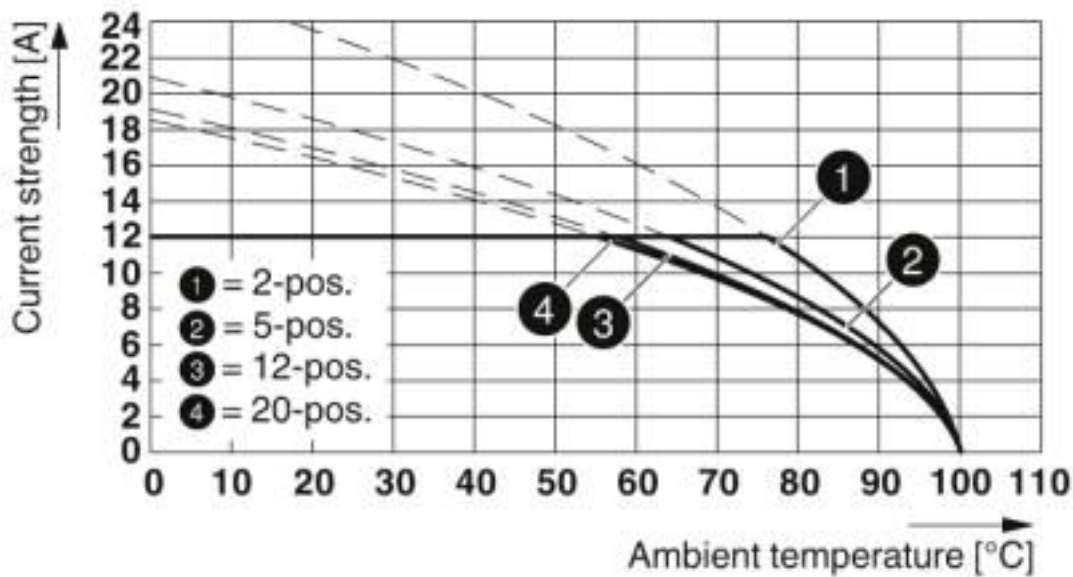

Type: MVSTBR 2,5/...-STF-5,08 with UMSTBVK 2,5/...-GF-5,08

Printed-circuit board connector - MVSTBR 2,5/10-STF-5,08 - 1835177

Dimensional drawing

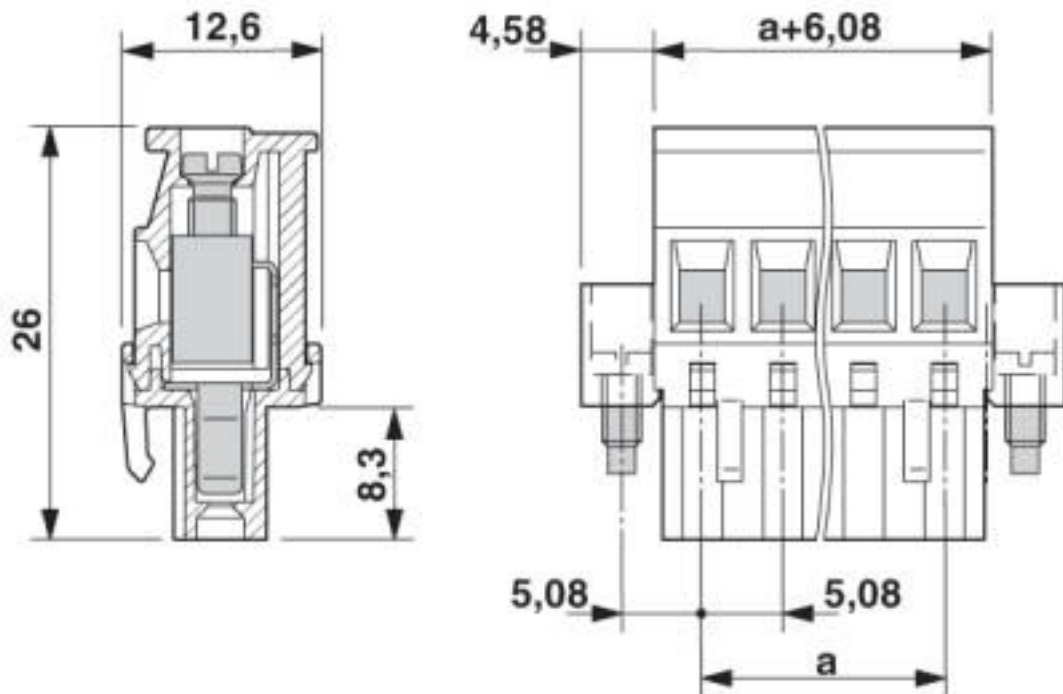

Classifications

eCl@ss

eCl@ss 10.0.1	27440309
eCl@ss 4.0	27260700
eCl@ss 4.1	27260700
eCl@ss 5.0	27260700
eCl@ss 5.1	27260700
eCl@ss 6.0	27260700
eCl@ss 7.0	27440309
eCl@ss 8.0	27440309
eCl@ss 9.0	27440309

ETIM

ETIM 3.0	EC001121
ETIM 4.0	EC002638
ETIM 5.0	EC002638
ETIM 6.0	EC002638
ETIM 7.0	EC002638

UNSPSC

UNSPSC 6.01	30211810
UNSPSC 7.0901	39121409

Printed-circuit board connector - MVSTBR 2,5/10-STF-5,08 - 1835177

Classifications

UNSPSC

UNSPSC 11	39121409
UNSPSC 12.01	39121409
UNSPSC 13.2	39121409
UNSPSC 18.0	39121409
UNSPSC 19.0	39121409
UNSPSC 20.0	39121409
UNSPSC 21.0	39121409

Approvals

Approvals

Approvals

CSA / IECCEB CB Scheme / EAC / cULus Recognized / VDE Zeichengenehmigung

Ex Approvals

Approval details

CSA		http://www.csagroup.org/services-industries/product-listing/	LR13631-2585950
	B	D	
Nominal voltage UN	300 V	300 V	
Nominal current IN	10 A	10 A	
mm ² /AWG/kcmil	28-12	28-12	

IECEE CB Scheme		http://www.iecee.org/	DE1-60988-B1B2
Nominal voltage UN	250 V		
Nominal current IN	12 A		
mm ² /AWG/kcmil	0.2-2.5		

EAC		B.01687
-----	--	---------

Printed-circuit board connector - MVSTBR 2,5/10-STF-5,08 - 1835177

Approvals

cULus Recognized		http://database.ul.com/cgi-bin/XYV/template/LISEXT/1FRAME/index.htm	E60425-19931011
	B	D	
Nominal voltage UN	300 V	300 V	
Nominal current IN	15 A	10 A	
mm ² /AWG/kcmil	30-12	30-12	

VDE Zeichengenehmigung		http://www2.vde.com/de/Institut/Online-Service/VDE-gepruefteProdukte/Seiten/Online-Suche.aspx	40050694
Nominal voltage UN	250 V		
Nominal current IN	12 A		
mm ² /AWG/kcmil	0.2-2.5		

Accessories

Accessories

Marker pen

Marker pen - B-STIFT - 1051993



Marker pen, for manual labeling of unprinted Zack strips, smear-proof and waterproof, line thickness 0.5 mm

Screwdriver tools

Screwdriver - SZS 0,6X3,5 - 1205053



Actuation tool, for ST terminal blocks, insulated, also suitable for use as a bladed screwdriver, size: 0.6 x 3.5 x 100 mm, 2-component grip, with non-slip grip

Terminal marking

Printed-circuit board connector - MVSTBR 2,5/10-STF-5,08 - 1835177

Accessories

Marker card - SK 5,08/3,8:UNBEDRUCKT - 0805412



Marker card, Card, white, unlabeled, can be labeled with: Marker pen, mounting type: adhesive, for terminal block width: 5.08 mm, lettering field size: 5.08 x 3.8 mm

Additional products

Feed-through header - MSTB 2,5/10-GF-5,08 - 1776582



PCB headers, nominal current: 12 A, rated voltage (III/2): 320 V, nominal cross section: 2.5 mm², number of positions: 10, pitch: 5.08 mm, color: green, contact surface: Tin, mounting: Wave soldering, pin layout: Linear pinning, solder pin [P]: 3.5 mm

Printed-circuit board connector - MSTBV 2,5/10-GF-5,08 - 1777154



PCB headers, nominal current: 12 A, rated voltage (III/2): 320 V, nominal cross section: 2.5 mm², number of positions: 10, pitch: 5.08 mm, color: green, contact surface: Tin, mounting: Wave soldering, pin layout: Linear pinning, solder pin [P]: 3.9 mm

Feed-through header - MDSTB 2,5/10-GF-5,08 - 1842445



PCB headers, nominal current: 10 A, rated voltage (III/2): 320 V, nominal cross section: 2.5 mm², number of positions: 10, pitch: 5.08 mm, color: green, contact surface: Tin, mounting: Wave soldering, pin layout: Linear pinning, solder pin [P]: 3.2 mm, The article can be aligned to create different nos. of positions! In combination with MVSTB or FKCV plug components, both an MVSTBW (or FKCVW) and an MVSTBR plug (or FKCVR) must be used. Combination with TMSTBP plug components is not possible!

Feed-through header - MDSTBV 2,5/10-GF-5,08 - 1845714



PCB headers, nominal current: 10 A, rated voltage (III/2): 320 V, nominal cross section: 2.5 mm², number of positions: 10, pitch: 5.08 mm, color: green, contact surface: Tin, mounting: Wave soldering, pin layout: Linear pinning, solder pin [P]: 3.9 mm, The article can be aligned to create different nos. of positions! In combination with MVSTB or FKCV plug components, both an MVSTBW (or FKCVW) and an MVSTBR plug (or FKCVR) must be used. Combination with TMSTBP plug components is not possible!

Printed-circuit board connector - MVSTBR 2,5/10-STF-5,08 - 1835177

Accessories

Printed-circuit board connector - DFK-MSTBA 2,5/10-GF-5,08 - 1899061



Feed-through header, nominal current: 12 A, rated voltage (III/2): 320 V, nominal cross section: 2.5 mm², number of positions: 10, pitch: 5.08 mm, color: green, contact surface: Tin, mounting: Wave soldering, pin layout: Linear pinning, solder pin [P]: 3.2 mm

Printed-circuit board connector - DFK-MSTBVA 2,5/10-GF-5,08 - 1899362



Feed-through header, nominal current: 12 A, rated voltage (III/2): 320 V, nominal cross section: 2.5 mm², number of positions: 10, pitch: 5.08 mm, color: green, contact surface: Tin, mounting: Wave soldering, pin layout: Linear pinning, solder pin [P]: 3.9 mm

Printed-circuit board connector - CC 2,5/10-GF-5,08 P26THR - 1954773



PCB headers, nominal current: 12 A, rated voltage (III/2): 320 V, nominal cross section: 2.5 mm², number of positions: 10, pitch: 5.08 mm, color: black, contact surface: Tin, mounting: THR soldering, pin layout: Linear pinning, solder pin [P]: 2.6 mm, User information and design recommendations for through hole reflow technology can be found under: Downloads

Printed-circuit board connector - CC 2,5/10-GF-5,08 P26THRR88 - 1954883



PCB headers, nominal current: 12 A, rated voltage (III/2): 320 V, nominal cross section: 2.5 mm², number of positions: 10, pitch: 5.08 mm, color: black, contact surface: Tin, mounting: THR soldering, pin layout: Linear pinning, solder pin [P]: 2.6 mm, User information and design recommendations for through hole reflow technology can be found under: Downloads

Printed-circuit board connector - CCV 2,5/10-GF-5,08 P26THR - 1955714



PCB headers, nominal current: 12 A, rated voltage (III/2): 320 V, nominal cross section: 2.5 mm², number of positions: 10, pitch: 5.08 mm, color: black, contact surface: Tin, mounting: THR soldering, pin layout: Linear pinning, solder pin [P]: 2.6 mm, User information and design recommendations for through hole reflow technology can be found under: Downloads

Printed-circuit board connector - MVSTBR 2,5/10-STF-5,08 - 1835177

Accessories

Printed-circuit board connector - CCV 2,5/10-GF-5,08 P26THRR88 - 1955824

PCB headers, nominal current: 12 A, rated voltage (III/2): 320 V, nominal cross section: 2.5 mm², number of positions: 10, pitch: 5.08 mm, color: black, contact surface: Tin, mounting: THR soldering, pin layout: Linear pinning, solder pin [P]: 2.6 mm, User information and design recommendations for through hole reflow technology can be found under: Downloads



Phoenix Contact 2020 © - all rights reserved
<http://www.phoenixcontact.com>

PHOENIX CONTACT GmbH & Co. KG
Flachsmarktstr. 8
32825 Blomberg
Germany
Tel. +49 5235 300
Fax +49 5235 3 41200
<http://www.phoenixcontact.com>

Mouser Electronics

Authorized Distributor

Click to View Pricing, Inventory, Delivery & Lifecycle Information:

[Phoenix Contact:](#)

[1835177](#)