

Single-line low capacitance and low leakage current ESD protection

Datasheet – production data

Features

- Single-line low capacitance Transil diode
- Bidirectional ESD protection
- Breakdown voltage $V_{BR} = 5.0 \text{ V min.}$
- Low diode capacitance (26 pF typ at 0 V)
- Low leakage current:
 - 10 nA at 3 V
 - 1 nA at 1 V
- Very small PCB area: 0.6 mm²
- ECOPACK[®]2 compliant components

Complies with the following standards:

- IEC 61000-4-2 level 4 and higher
 - 30 kV (air discharge)
 - 30 kV (contact discharge)
- MIL STD 883G - Method 3015-7: class 3
 - Human body model

Applications

Where transient overvoltage protection in ESD sensitive equipment is required, such as:

- Portable multimedia players and accessories
- Portable healthcare equipment
- Notebooks
- Communication systems
- Cellular phone handsets and accessories

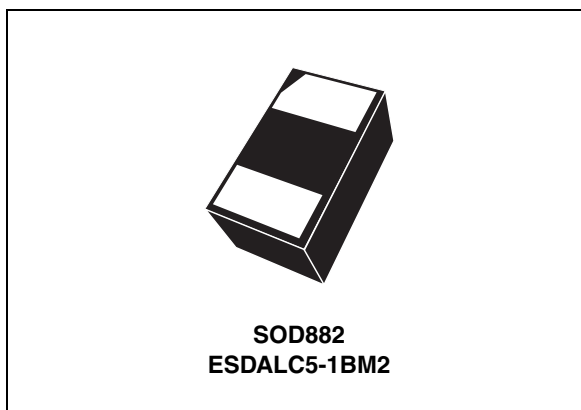
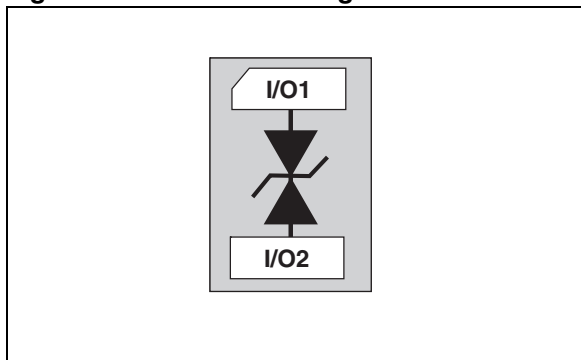

Figure 1. Functional diagram



Description

The ESDALCL5-1BM2 is a bidirectional single-line TVS diode designed to protect data lines or other I/O ports against ESD transients.

This device is ideal for applications where reduced line capacitance and board space saving are required. Its low leakage current makes it suitable for portable equipment.

1 Characteristics

Table 1. Absolute maximum ratings ($T_{amb} = 25\text{ °C}$)

Symbol	Parameter		Value	Unit
V_{PP}	Peak pulse voltage	IEC 61000-4-2 contact discharge IEC 61000-4-2 air discharge	± 30	kV
$P_{PP}^{(1)}$	Peak pulse power dissipation (8/20 μ s)	T_j initial = T_{amb}	150	W
I_{PP}	Peak pulse current (8/20 μ s)		9	A
T_j	Junction temperature		-55 to +150	$^{\circ}\text{C}$
T_{stg}	Storage temperature range		-65 to +150	$^{\circ}\text{C}$
T_L	Maximum lead temperature for soldering during 10 s		260	$^{\circ}\text{C}$

1. For a surge greater than the maximum values, the diode will fail in short-circuit.

Figure 2. Electrical characteristics (definitions)

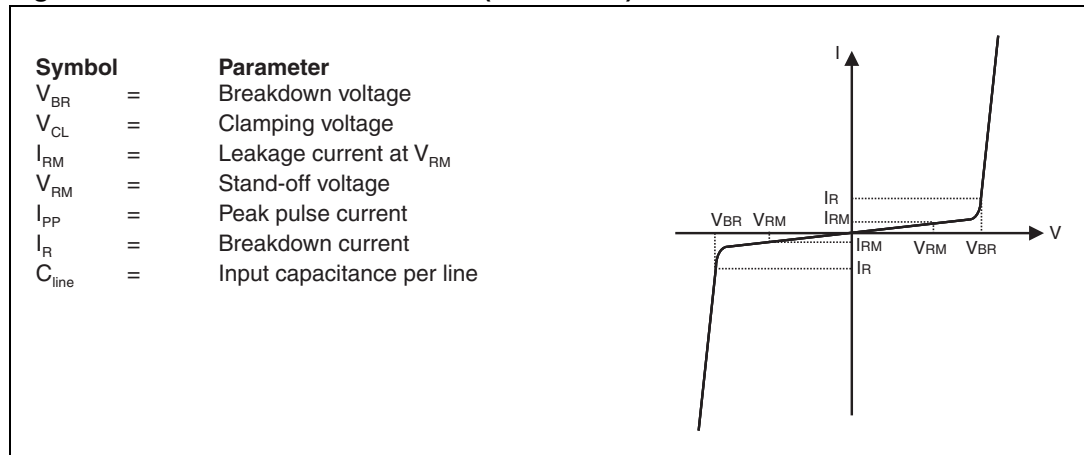

Table 2. Electrical characteristics (values, $T_{amb} = 25\text{ °C}$)

Symbol	Test condition	Min.	Typ.	Max.	Unit
V_{BR}	From pin1 to pin2, $I_R = 1\text{ mA}$	11	13		V
	From pin2 to pin1, $I_R = 1\text{ mA}$	5	8		
I_{RM}	$V_{RM} = 3\text{ V}$			10	nA
	$V_{RM} = 1\text{ V}$			1	
R_d	Square pulse, $I_{PP} = 1\text{ A}$, $t_p = 2.5\text{ }\mu\text{s}$		650		m Ω
C_{line}	$F = 1\text{ MHz}$, $V_R = 0\text{ V}$		26	30	pF

Figure 3. Relative variation of peak pulse power versus initial junction temperature

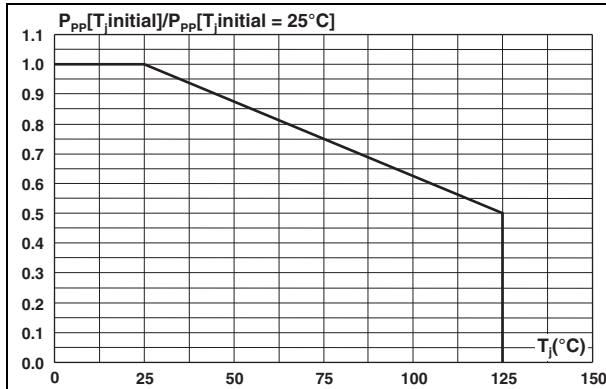

Figure 4. Leakage current versus junction temperature (typical values, $V_R = 1\text{ V}$)

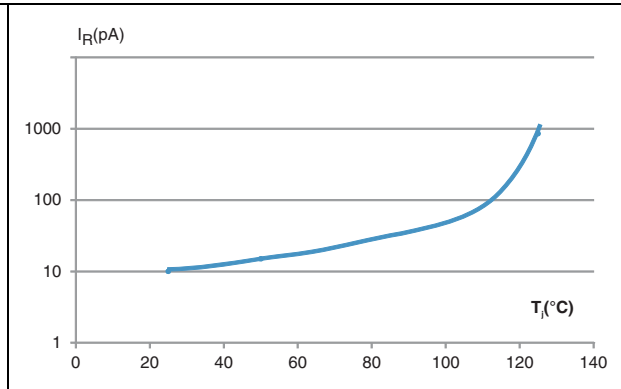

Figure 5. Leakage current versus reverse applied voltage (typical values)

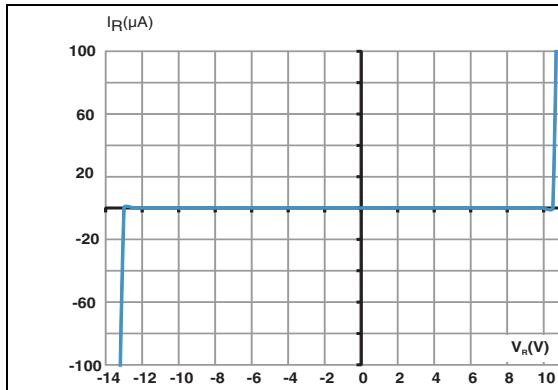

Figure 6. Peak pulse power versus exponential pulse duration (direct)

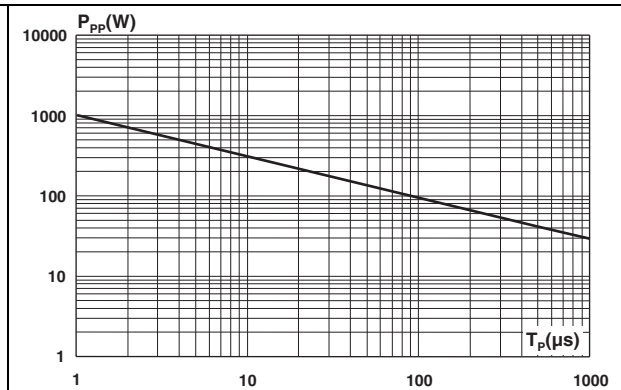

Figure 7. Peak pulse power versus exponential pulse duration (reverse)

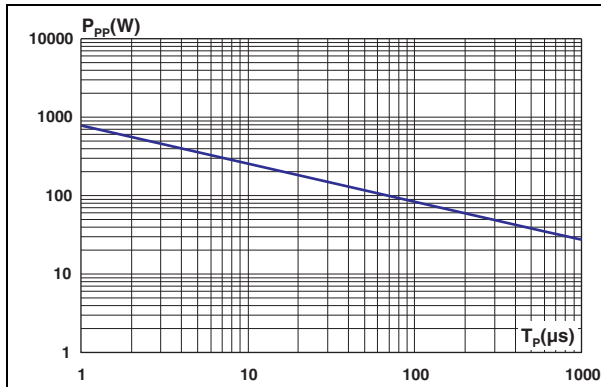

Figure 8. Clamping voltage versus peak pulse current (typical values, exponential waveform, direct)

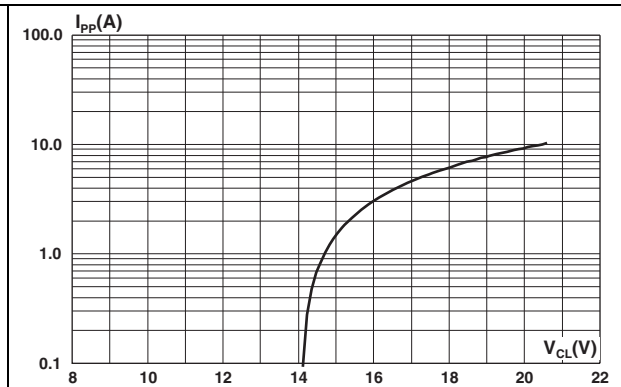

Figure 9. Clamping voltage versus peak pulse current (typical values, exponential waveform, reverse)

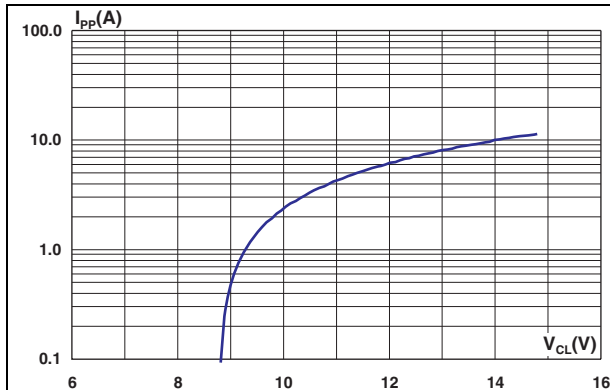

Figure 10. Junction capacitance versus reverse applied voltage (typical values, direct)

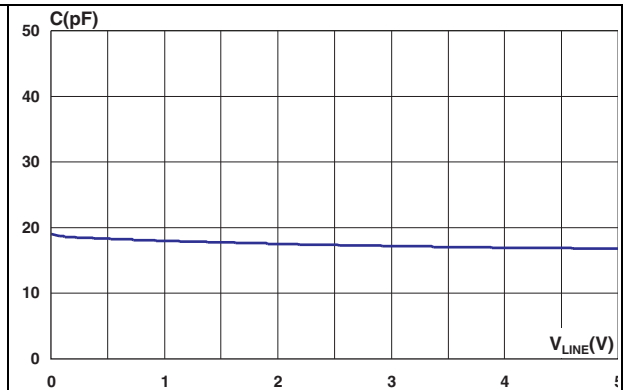

Figure 11. Junction capacitance versus reverse applied voltage (typical values, reverse)

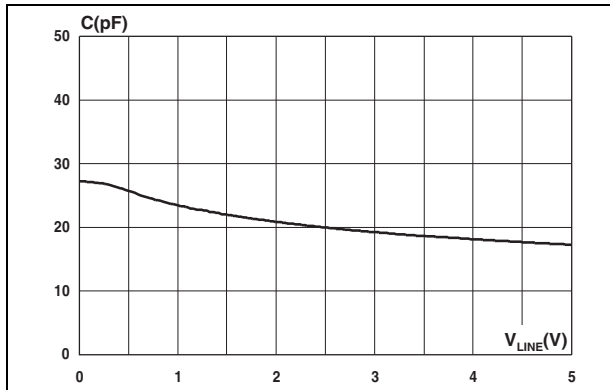

Figure 12. ESD response to IEC 61000-4-2 (+30 kV contact discharge)

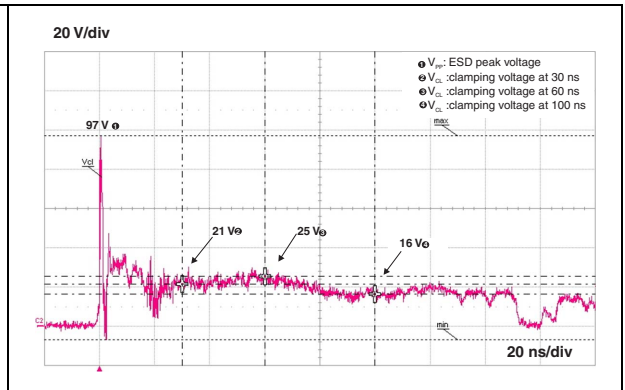

Figure 13. ESD response to IEC 61000-4-2 (-30 kV contact discharge)

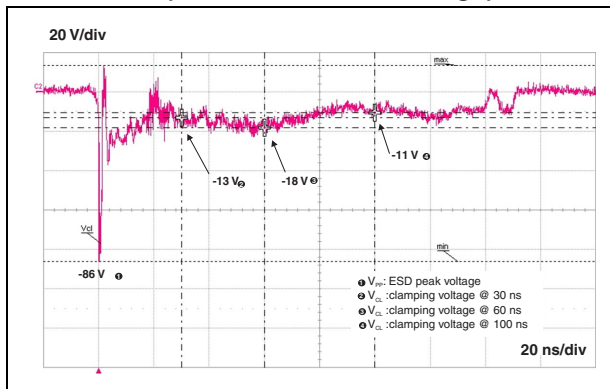
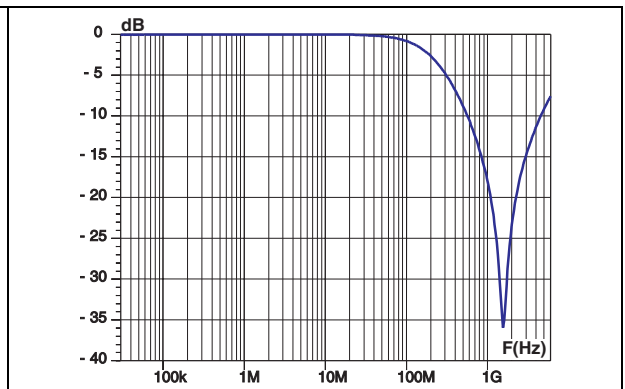
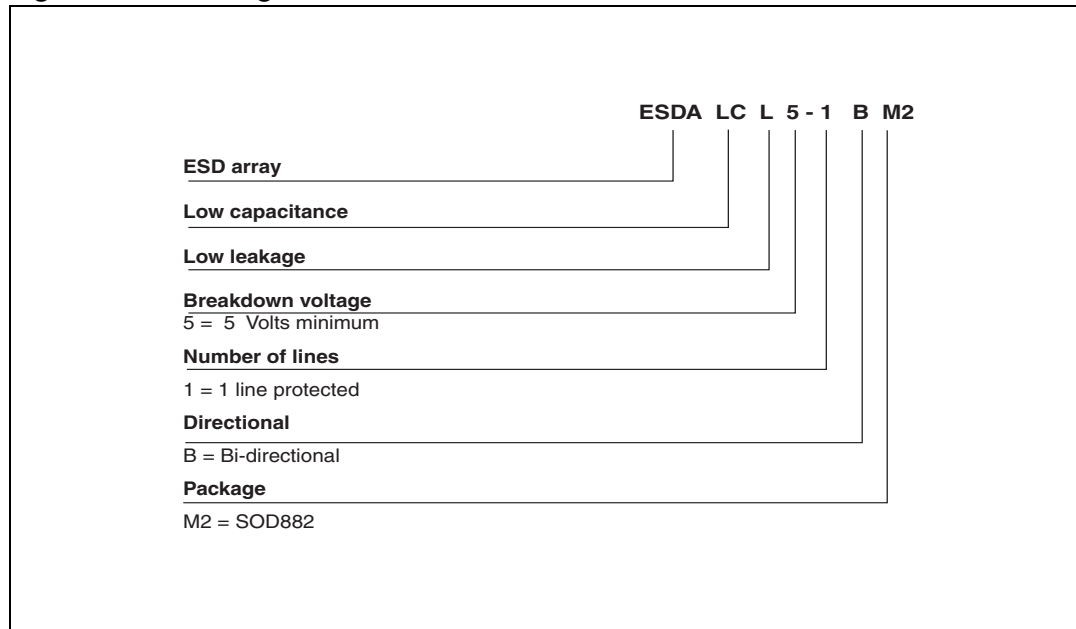

Figure 14. S21 attenuation measurement result



2 Ordering information scheme

Figure 15. Ordering information scheme



3 Package information

- Epoxy meets UL94, V0
- Lead-free package

In order to meet environmental requirements, ST offers these devices in different grades of ECOPACK® packages, depending on their level of environmental compliance. ECOPACK® specifications, grade definitions and product status are available at: www.st.com. ECOPACK® is an ST trademark.

Figure 16. SOD882 dimension definitions

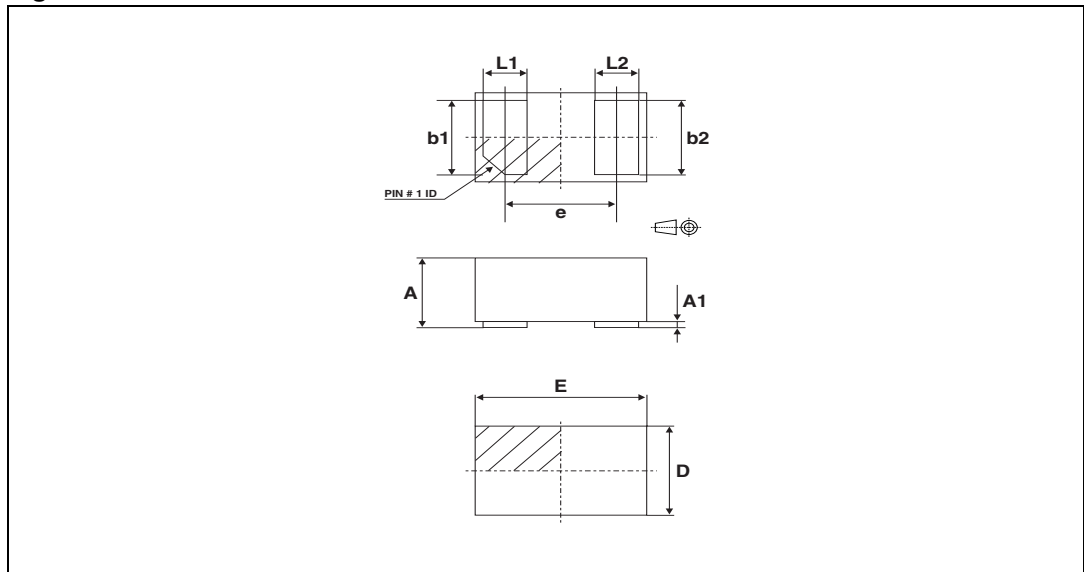

Table 3. SOD882 dimension values

Ref.	Dimensions					
	Millimeters			Inches		
	Min.	Typ.	Max.	Min.	Typ.	Max.
A	0.40	0.47	0.50	0.016	0.019	0.020
A1	0.00		0.05	0.000		0.002
b1	0.45	0.50	0.55	0.018	0.020	0.022
b2	0.45	0.50	0.55	0.018	0.020	0.022
D	0.55	0.60	0.65	0.022	0.024	0.026
E	0.95	1.00	1.05	0.037	0.039	0.041
e	0.60	0.65	0.70	0.024	0.026	0.028
L1	0.20	0.25	0.30	0.008	0.010	0.012
L2	0.20	0.25	0.30	0.008	0.010	0.012

Figure 17. SOD882 footprint in mm (inches)

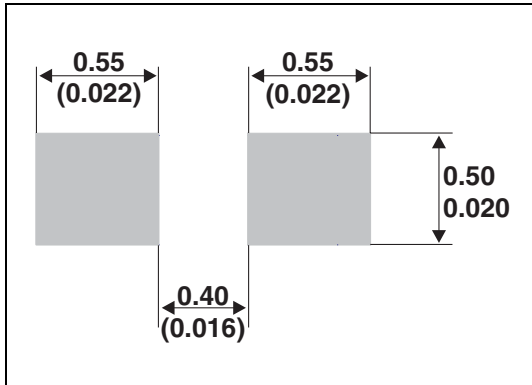
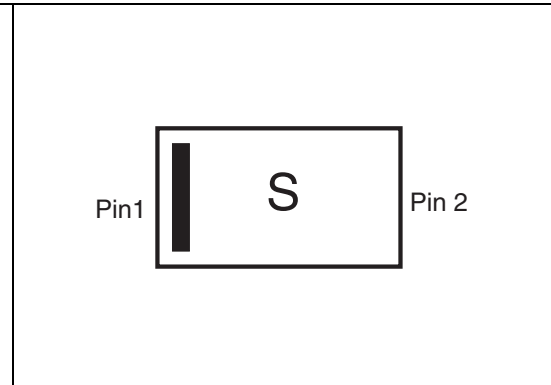
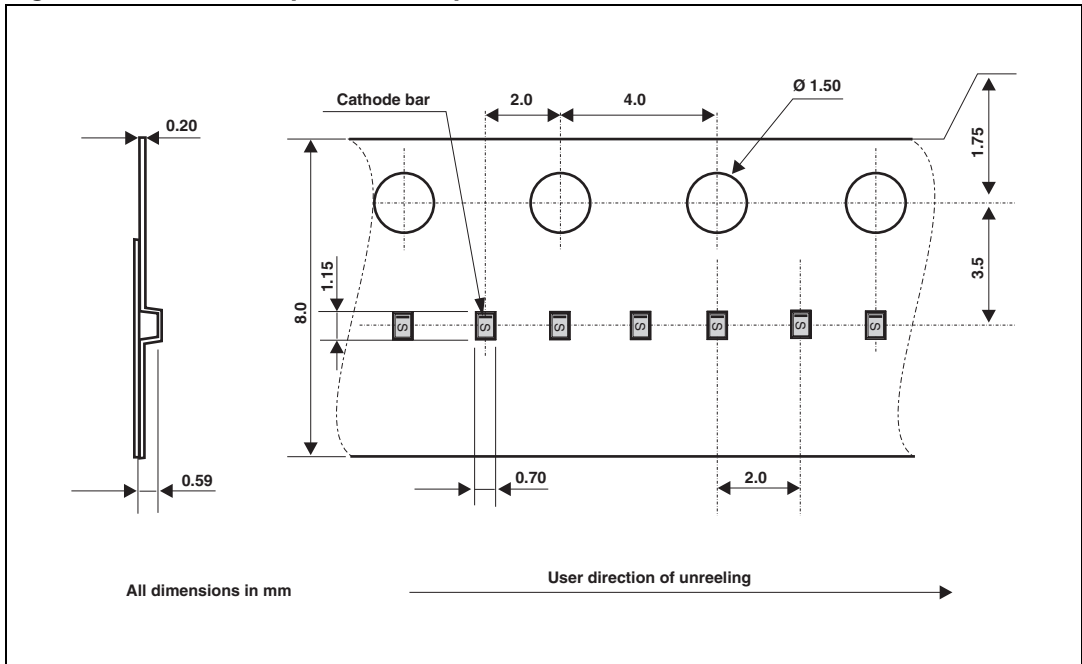

Figure 18. SOD882 marking



Note: Product marking may be rotated by multiples of 90° for assembly plant differentiation. In no case should this product marking be used to orient the component for its placement on a PCB. Only pin 1 mark is to be used for this purpose.

Figure 19. SOD882 tape and reel specifications



4 Recommendations on PCB assembly

4.1 Stencil opening design

1. General recommendation on stencil opening design
 - a) Stencil opening dimensions: L (Length), W (Width), T (Thickness).

Figure 20. Stencil opening dimensions

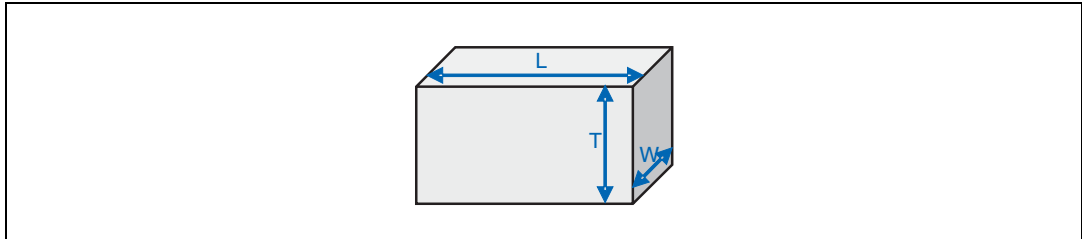

- b) General design rule
 - Stencil thickness (T) = 75 ~ 125 μm
 - Aspect Ratio = $\frac{W}{T} \geq 1.5$
 - Aspect Area = $\frac{L \times W}{2T(L + W)} \geq 0.66$

2. Reference design
 - a) Stencil opening thickness: 100 μm
 - b) Stencil opening for central exposed pad: Opening to footprint ratio is 50%.
 - c) Stencil opening for leads: Opening to footprint ratio is 90%.

Figure 21. Recommended stencil window position

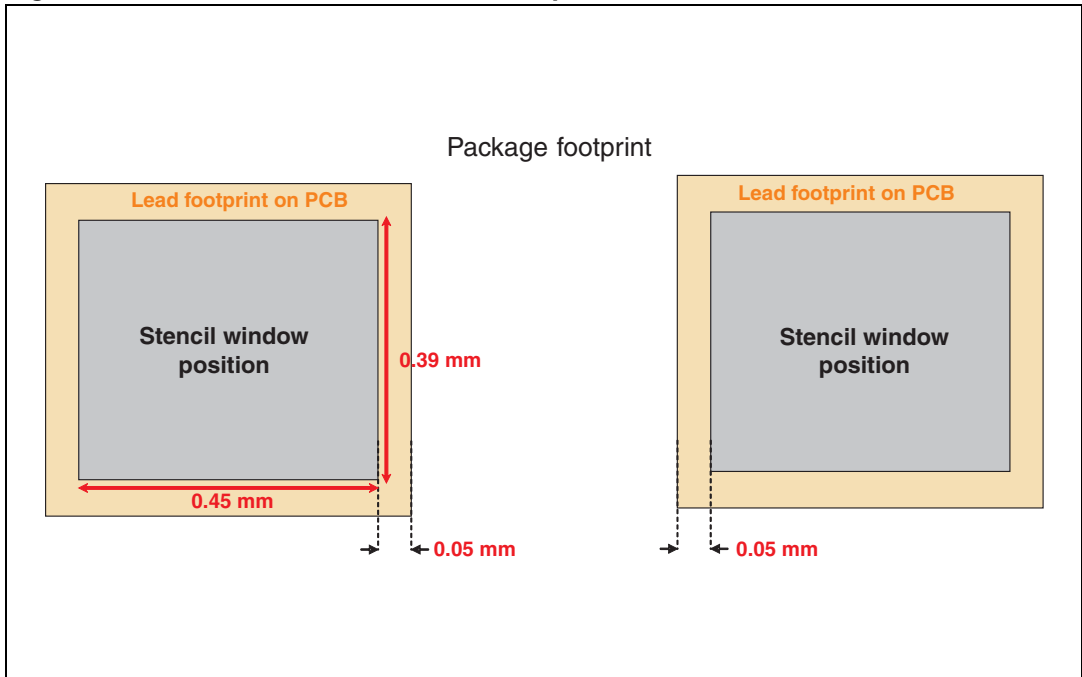

4.2 Solder paste

1. Halide-free flux qualification ROL0 according to ANSI/J-STD-004.
2. “No clean” solder paste is recommended.
3. Offers a high tack force to resist component movement during high speed.
4. Solder paste with fine particles: powder particle size is 20-45 μm .

4.3 Placement

1. Manual positioning is not recommended.
2. It is recommended to use the lead recognition capabilities of the placement system, not the outline centering.
3. Standard tolerance of ± 0.05 mm is recommended.
4. 3.5 N placement force is recommended. Too much placement force can lead to squeezed out solder paste and cause solder joints to short. Too low placement force can lead to insufficient contact between package and solder paste that could cause open solder joints or badly centered packages.
5. To improve the package placement accuracy, a bottom side optical control should be performed with a high resolution tool.
6. For assembly, a perfect supporting of the PCB (all the more on flexible PCB) is recommended during solder paste printing, pick and place and reflow soldering by using optimized tools.

4.4 PCB design preference

1. To control the solder paste amount, the closed via is recommended instead of open vias.
2. The position of tracks and open vias in the solder area should be well balanced. The symmetrical layout is recommended, in case any tilt phenomena caused by asymmetrical solder paste amount due to the solder flow away.

4.5 Reflow profile

Figure 22. ST ECOPACK[®] recommended soldering reflow profile for PCB mounting

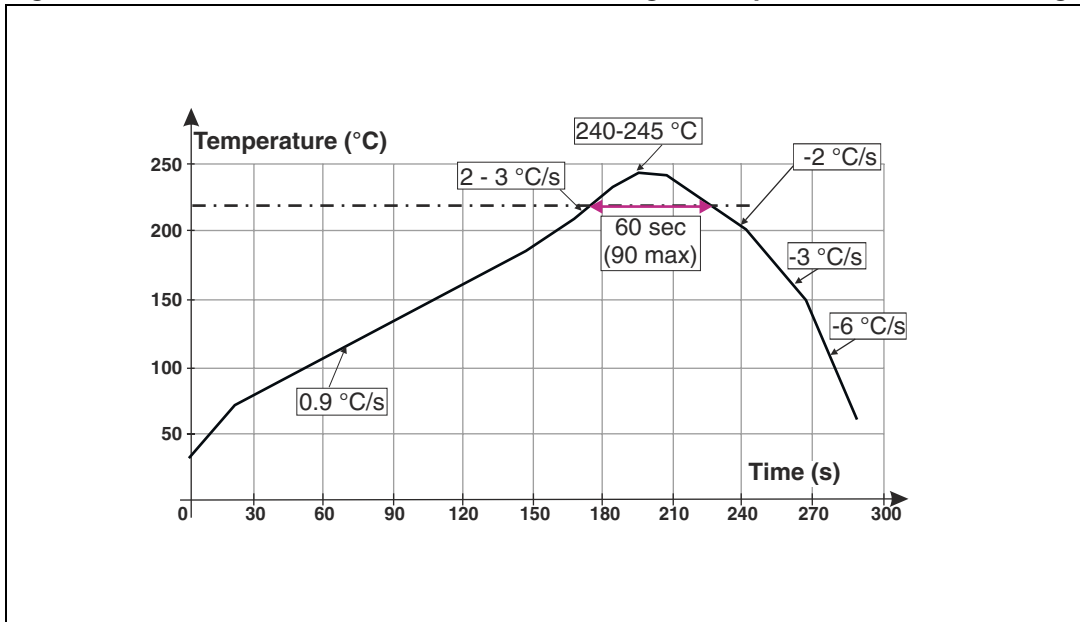

Note: Minimize air convection currents in the reflow oven to avoid component movement.

5 Ordering information

Table 4. Ordering information

Order code	Marking ⁽¹⁾	Package	Weight	Base qty	Delivery mode
ESDALCL5-1BM2	S	SOD882	0.92 mg	12,000	Tape and reel

1. The marking can be rotated by multiples of 90° to differentiate assembly location

6 Revision history

Table 5. Document revision history

Date	Revision	Changes
31-Oct-2012	1	Initial release.

Please Read Carefully:

Information in this document is provided solely in connection with ST products. STMicroelectronics NV and its subsidiaries ("ST") reserve the right to make changes, corrections, modifications or improvements, to this document, and the products and services described herein at any time, without notice.

All ST products are sold pursuant to ST's terms and conditions of sale.

Purchasers are solely responsible for the choice, selection and use of the ST products and services described herein, and ST assumes no liability whatsoever relating to the choice, selection or use of the ST products and services described herein.

No license, express or implied, by estoppel or otherwise, to any intellectual property rights is granted under this document. If any part of this document refers to any third party products or services it shall not be deemed a license grant by ST for the use of such third party products or services, or any intellectual property contained therein or considered as a warranty covering the use in any manner whatsoever of such third party products or services or any intellectual property contained therein.

UNLESS OTHERWISE SET FORTH IN ST'S TERMS AND CONDITIONS OF SALE ST DISCLAIMS ANY EXPRESS OR IMPLIED WARRANTY WITH RESPECT TO THE USE AND/OR SALE OF ST PRODUCTS INCLUDING WITHOUT LIMITATION IMPLIED WARRANTIES OF MERCHANTABILITY, FITNESS FOR A PARTICULAR PURPOSE (AND THEIR EQUIVALENTS UNDER THE LAWS OF ANY JURISDICTION), OR INFRINGEMENT OF ANY PATENT, COPYRIGHT OR OTHER INTELLECTUAL PROPERTY RIGHT.

UNLESS EXPRESSLY APPROVED IN WRITING BY TWO AUTHORIZED ST REPRESENTATIVES, ST PRODUCTS ARE NOT RECOMMENDED, AUTHORIZED OR WARRANTED FOR USE IN MILITARY, AIR CRAFT, SPACE, LIFE SAVING, OR LIFE SUSTAINING APPLICATIONS, NOR IN PRODUCTS OR SYSTEMS WHERE FAILURE OR MALFUNCTION MAY RESULT IN PERSONAL INJURY, DEATH, OR SEVERE PROPERTY OR ENVIRONMENTAL DAMAGE. ST PRODUCTS WHICH ARE NOT SPECIFIED AS "AUTOMOTIVE GRADE" MAY ONLY BE USED IN AUTOMOTIVE APPLICATIONS AT USER'S OWN RISK.

Resale of ST products with provisions different from the statements and/or technical features set forth in this document shall immediately void any warranty granted by ST for the ST product or service described herein and shall not create or extend in any manner whatsoever, any liability of ST.

ST and the ST logo are trademarks or registered trademarks of ST in various countries.

Information in this document supersedes and replaces all information previously supplied.

The ST logo is a registered trademark of STMicroelectronics. All other names are the property of their respective owners.

© 2012 STMicroelectronics - All rights reserved

STMicroelectronics group of companies

Australia - Belgium - Brazil - Canada - China - Czech Republic - Finland - France - Germany - Hong Kong - India - Israel - Italy - Japan - Malaysia - Malta - Morocco - Philippines - Singapore - Spain - Sweden - Switzerland - United Kingdom - United States of America

www.st.com