

GoldMax 300 Auto X8L HT150C, Ceramic, 1.8 uF, 10%, 50 VDC, X8L, "GoldMax, Automotive Grade", Lead Spacing = 2.54mm

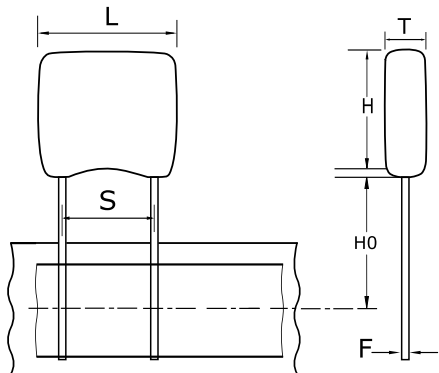

General Information	
Series:	GoldMax 300 Auto X8L HT150C
Style:	Radial
Description:	"GoldMax, Automotive Grade"
Features:	Automotive Grade
RoHS:	Yes
Termination:	Tin
Failure Rate:	N/A
Qualifications:	AEC-Q200
AEC-Q200:	Yes
Halogen Free:	Yes

Dimensions	
L	5.08mm MAX
H	5.84mm MAX
T	3.18mm MAX
S	2.54mm +/-0.78mm
H0	16mm +/-0.5mm
F	0.51mm +0.1/-0.025mm

Specifications	
Capacitance:	1.8 uF
Capacitance Tolerance:	10%
Voltage DC:	50 VDC
Dielectric Withstanding Voltage:	125 VDC
Temperature Range:	-55/+150°C
Temperature Coefficient:	X8L
Dissipation Factor:	2.5%
Aging Rate:	3% Loss/Decade Hour
Insulation Resistance:	555.6 MOhms

Packaging Specifications	
Packaging:	T&R, 305mm
Packaging Quantity:	2500

Statements of suitability for certain applications are based on our knowledge of typical operating conditions for such applications, but are not intended to constitute - and we specifically disclaim - any warranty concerning suitability for a specific customer application or use. This Information is intended for use only by customers who have the requisite experience and capability to determine the correct products for their application. Any technical advice inferred from this Information or otherwise provided by us with reference to the use of our products is given gratis, and we assume no obligation or liability for the advice given or results obtained.