

Description

The AP7353 is a low dropout regulator with high output voltage accuracy, low $R_{DS(ON)}$, high PSRR, low output noise and low quiescent current. This regulator is based on a CMOS process.

The AP7353 includes a voltage reference, error amplifier, current limit circuit and an enable input to turn it on and off. With the integrated resistor network, fixed output voltage versions can be delivered.

With its high PSRR, good line regulation and fast load transient response, the AP7353 is well suited for handheld/wearable communication equipments which require stable voltage sources.

The AP7353 is packaged in X1-WLB0707-4 (Type A1) which allows for smallest footprint and dense PCB layout.

Features

- Low V_{IN} and Wide V_{IN} Range: 2.0V to 5.5V
- Guarantee Output Current, 250mA
- V_{OUT} Accuracy $\pm 1\%$
- Ripple Rejection 90dB at 20Hz to 20kHz, $I_{OUT} = 10mA$
- Low Output Noise, 10 μ Vrms from 10Hz to 100kHz at 10mA
- Quiescent Current as Low as 18 μ A (Typ.)
- V_{OUT} Fixed 1.8V to 4.5V
- **Totally Lead-Free & Fully RoHS Compliant (Notes 1 & 2)**
- **Halogen and Antimony Free, Green Device (Note 3)**

Pin Assignments

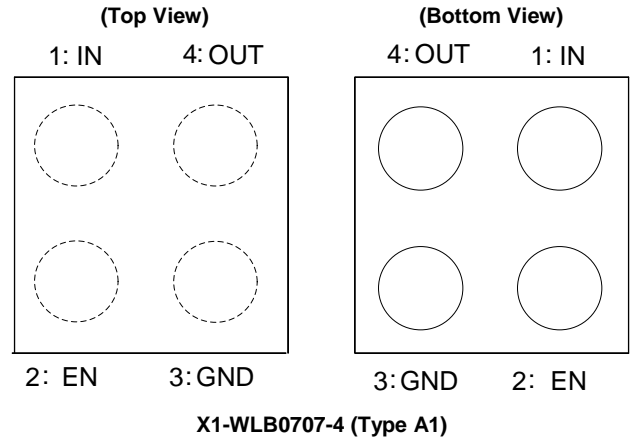

Applications

- Smart Phone/PAD
- RF Supply
- Cameras
- Portable Video
- Portable Media Player
- Wireless Adapter
- Wireless Communication

- Notes:
1. No purposely added lead. Fully EU Directive 2002/95/EC (RoHS), 2011/65/EU (RoHS 2) & 2015/863/EU (RoHS 3) compliant.
 2. See <https://www.diodes.com/quality/lead-free/> for more information about Diodes Incorporated's definitions of Halogen- and Antimony-free, "Green" and Lead-free.
 3. Halogen- and Antimony-free "Green" products are defined as those which contain <900ppm bromine, <900ppm chlorine (<1500ppm total Br + Cl) and <1000ppm antimony compounds.

Typical Applications Circuit

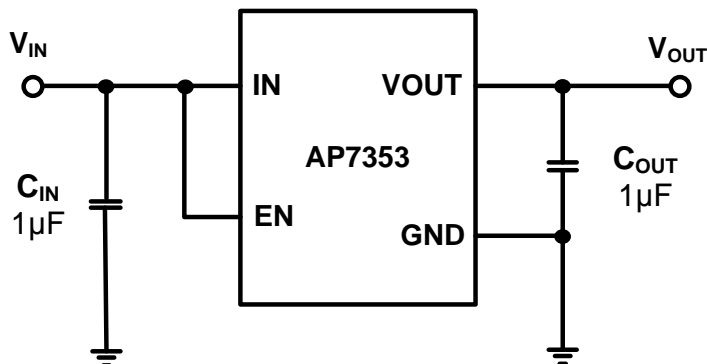

Pin Descriptions

Pin Number	Pin Name	Function
1	IN	Power Input Pin
2	EN	Enable Pin This pin should be driven either high or low and must not be floating. Driving this pin high enables the regulator, while pulling it low puts the regulator into shutdown mode
3	GND	Ground
4	OUT	Power Output Pin

Functional Block Diagram

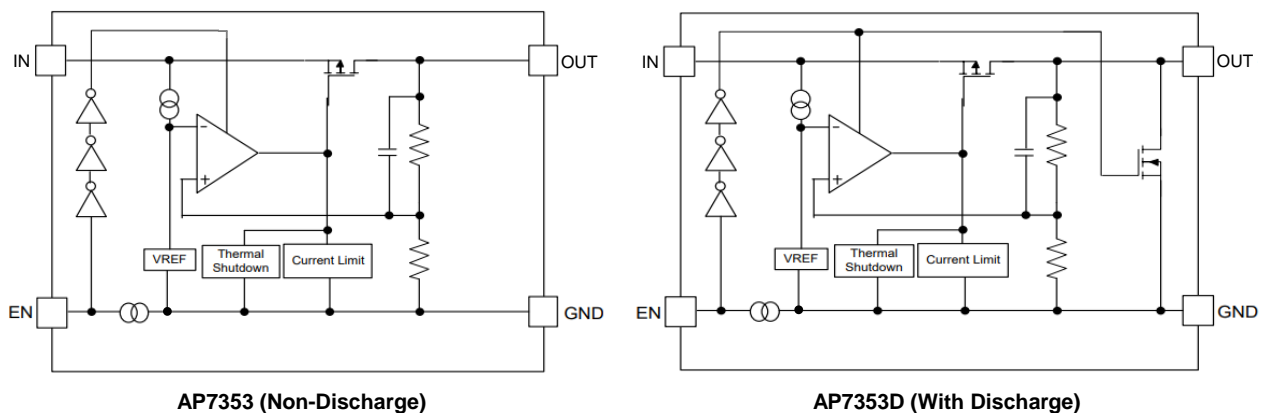
AP7353 (Non-Discharge)
AP7353D (With Discharge)

Absolute Maximum Ratings (Note 4) (@ $T_A = +25^\circ\text{C}$, unless otherwise specified.)

Symbol	Parameter	Ratings	Unit
ESD HBM	Human Body Mode ESD Protection	>2	kV
ESD CDM	Charge Device Model	± 500	V
V_{IN}	Input Voltage	6.0	V
V_{EN}	Input Voltage EN	6.0	V
V_{OUT}	Output Voltage	-0.3 to 6.0	V
I_{OUT}	Output Current	250	mA
P_D	Power Dissipation (Note 5)	800	mW
T_A	Operating Ambient Temperature	-40 to +85	$^\circ\text{C}$
T_J	Operating Junction Temperature	+125	$^\circ\text{C}$
T_{STG}	Storage Temperature	-55 to +150	$^\circ\text{C}$

- Notes:
- Stresses beyond those listed under *Absolute Maximum Ratings* can cause permanent damage to the device. These are stress ratings only and functional operation of the device at these conditions is not implied. Exposure to absolute-maximum-rated conditions for extended periods can affect device reliability.
 - Ratings apply to ambient temperature at +25 $^\circ\text{C}$. The device mounted on FR-4 substrate PC board and calculated in accordance with JEDEC 51-7.

Recommended Operating Conditions (@ $T_A = +25^\circ\text{C}$, unless otherwise specified.)

Symbol	Parameter	Min	Max	Unit
V_{IN}	Input Voltage	2.0	5.5	V
I_{OUT}	Output Current	0	250	mA
T_A	Operating Ambient Temperature	-40	+85	$^\circ\text{C}$

Electrical Characteristics (@ $V_{EN} = V_{IN} = V_{OUT} + 1.0V$, $C_{IN} = C_{OUT} = 1\mu F$, $I_{OUT} = 1.0mA$ @ $T_A = +25^\circ C$, unless otherwise specified.)

Parameter	Conditions	Min	Typ	Max	Unit	
Input Voltage	$T_A = -40^\circ C$ to $+85^\circ C$	2.0	—	5.5	V	
Output Voltage Accuracy (Note 11)	$V_{IN} = (V_{OUT_Nom} + 1.0V)$ to 5.5V, $I_{OUT} = 1mA$ to 250mA	-1	—	+1	%	
Line Regulation ($dV_{OUT}/dV_{IN}/V_{OUT}$)	$V_{IN} = (V_{OUT_Nom} + 1.0V)$ to 5.25V	—	0.02	—	%/V	
Load Regulation ($dV_{OUT}/V_{OUT}/dI_{OUT}$)	$V_{IN} = V_{OUT_Nom} + 1.0V$, $I_{OUT} = 1mA$ to 250mA	—	0.001	—	%/mA	
Quiescent Current (Note 7)	$I_{OUT} = 0mA$, $V_{EN} = 1.2V$	—	18	27	μA	
Standby Current ($I_{STANDBY}$)	$V_{EN} = 0V$ (Disabled)	—	0.1	1.0	μA	
Output Current	—	—	—	250	mA	
Output Current Limit	$V_{OUT} = 90\% V_{OUT}$	260	—	—	mA	
PSRR (Note 8)	$V_{IN} = [V_{OUT} + 1V]$ VDC + 0.2Vp-pAC, $V_{OUT} \geq 1.8V$, $I_{OUT} = 10mA$	$f = 100Hz$	—	90	—	dB
		$f = 1kHz$	—	90	—	
		$f = 10kHz$	—	70	—	
Output Noise Voltage (Note 8) (Note 9)	BW = 10Hz to 100kHz, $I_{OUT} = 10mA$	—	10	—	μV_{rms}	
Dropout Voltage (Note 6)	$I_{OUT} = 250mA$	$V_{OUT} = 1.8V$	—	115	237	mV
		$V_{OUT} = 2.5V$	—	75	166	
		$V_{OUT} = 2.8V$	—	73	152	
		$V_{OUT} = 2.85V$	—	73	152	
		$V_{OUT} = 2.9V$	—	71	150	
		$V_{OUT} = 3.0V$	—	68	147	
		$V_{OUT} = 3.1V$	—	68	147	
		$V_{OUT} = 3.2V$	—	67	142	
		$V_{OUT} = 3.3V$	—	65	138	
		$V_{OUT} = 3.6V$	—	60	119	
$V_{OUT} = 4.5V$	—	55	114			
Output Voltage Temperature Coefficient	$I_{OUT} = 30mA$, $T_A = -40^\circ C$ to $+85^\circ C$	—	± 30	—	ppm/ $^\circ C$	
Turn-On Time	90% of Typical V_{OUT}	—	180	—	μs	
EN Input Low Voltage	—	0.0	—	0.4	V	
EN Input High Voltage	—	1.2	—	5.5	V	
EN Input Leakage	$V_{EN} = 0$, $V_{IN} = 5.0V$ or $V_{EN} = 5.0V$, $V_{IN} = 0V$	-1.0	—	+1.0	μA	
On Resistance of N-Channel for Auto-Discharge (Note 10)	$V_{IN} = 4.0V$, $V_{EN} = 0V$ (Disabled)	—	35	—	Ω	

- Notes:
6. Dropout voltage is the voltage difference between the input and the output at which the output voltage drops 2% below its nominal value.
 7. Quiescent current is defined here as the difference in current between the input and the output.
 8. This specification is guaranteed by design.
 9. To make sure lowest environment noise minimizes the influence on noise measurement.
 10. AP7353 has 2 options for output, built-in discharge and non-discharge.
 11. Potential multiple grades based on following output voltage accuracy.

Typical Performance Characteristics

NEW PRODUCT

Output Voltage vs. Temperature, $V_{OUT}=1.8V$

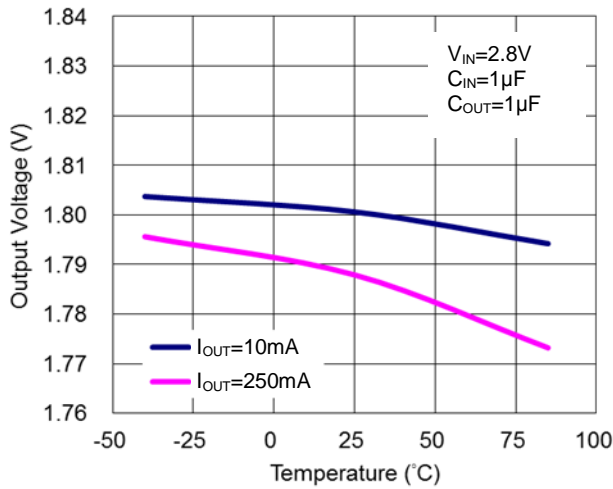

Output Voltage vs. Temperature, $V_{OUT}=3.3V$

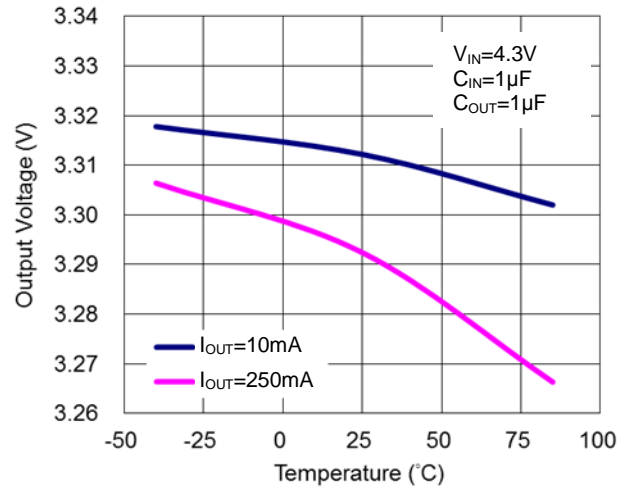

Line Regulation vs. Temperature, $V_{OUT}=1.8V$

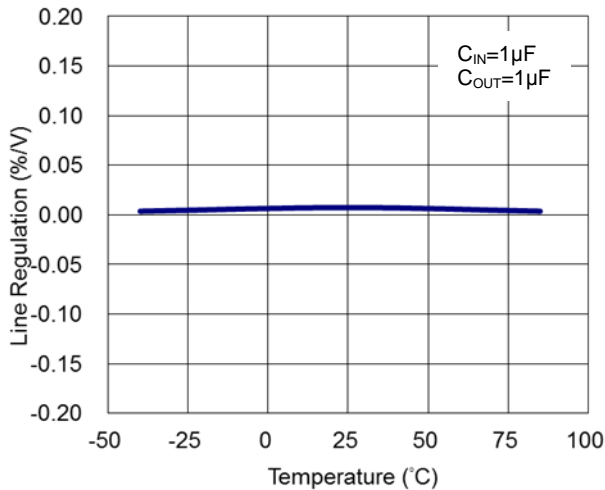

Line Regulation vs. Temperature, $V_{OUT}=3.3V$

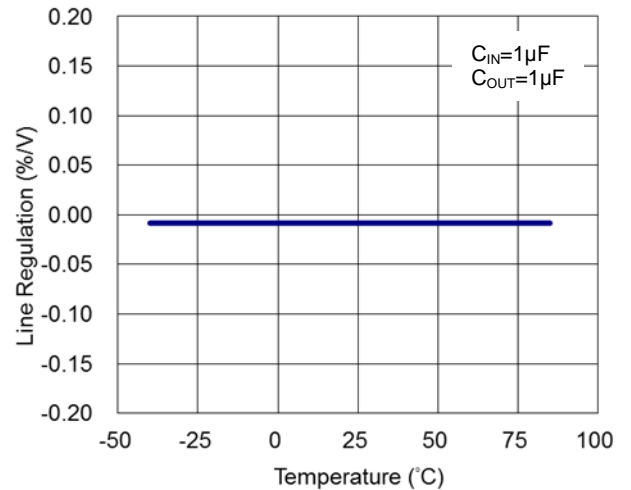

Load Regulation vs. Temperature, $V_{OUT}=1.8V$

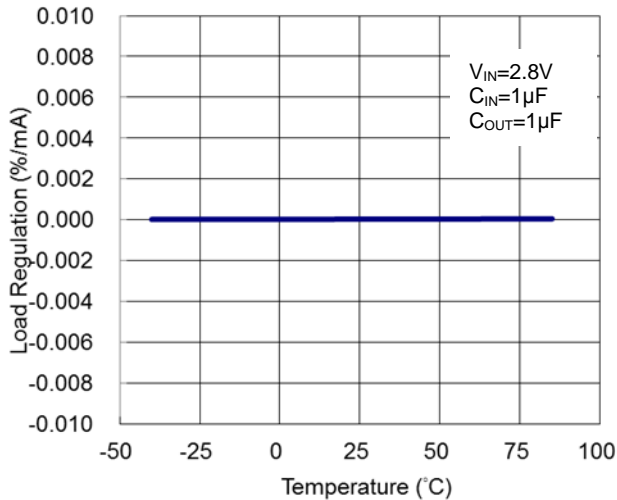

Load Regulation vs. Temperature, $V_{OUT}=3.3V$

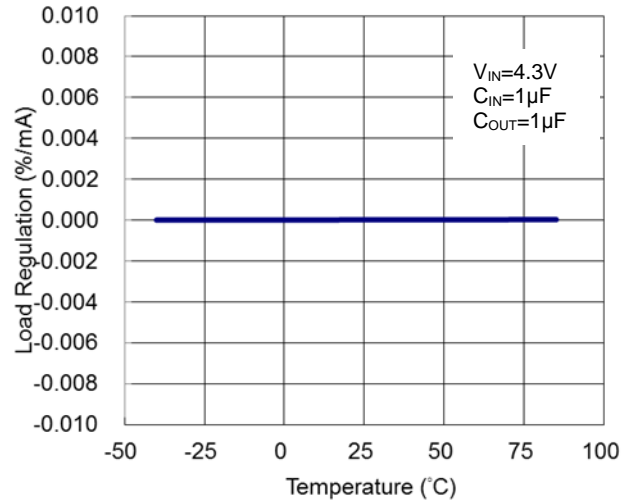

Typical Performance Characteristics (continued)

NEW PRODUCT

Dropout Voltage vs. I_{OUT} , $V_{OUT} = 1.8V$

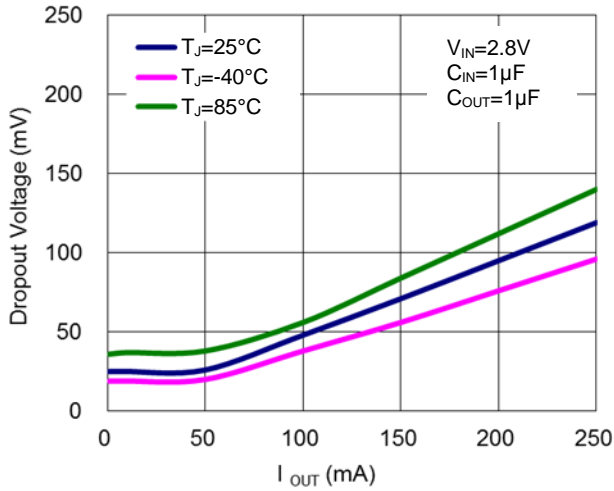

Dropout Voltage vs. I_{OUT} , $V_{OUT} = 3.3V$

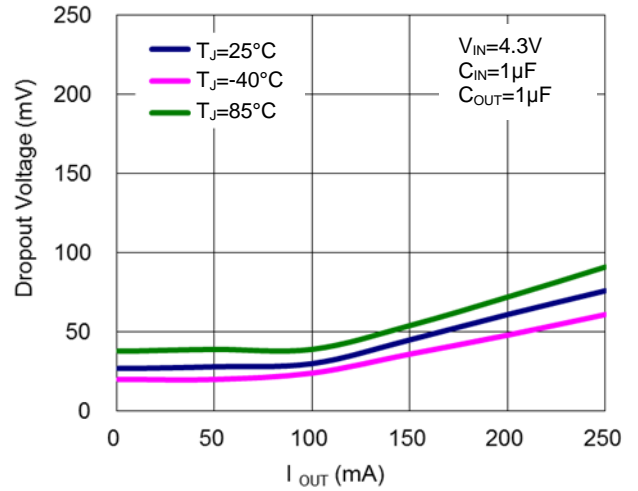

Dropout Voltage vs. Temperature, $V_{OUT} = 1.8V$

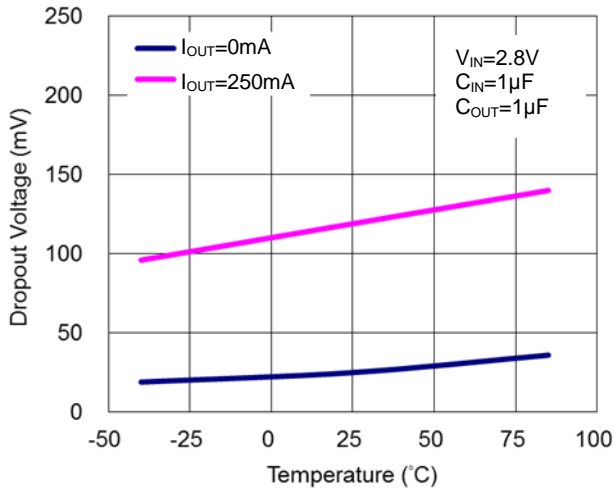

Dropout Voltage vs. Temperature, $V_{OUT} = 3.3V$

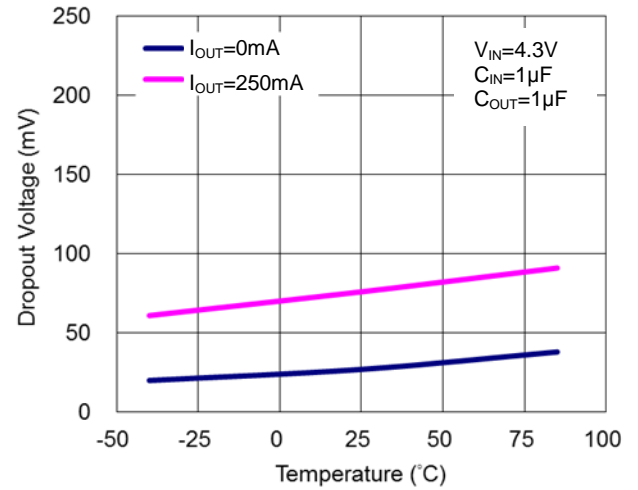

Current Limit vs. Temperature

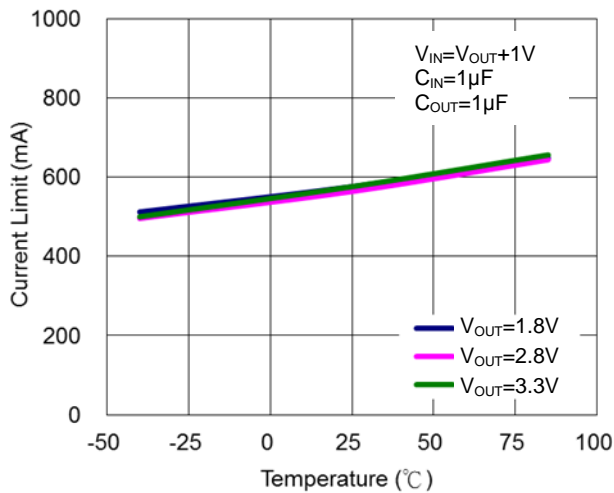

Short Circuit Current vs. Temperature

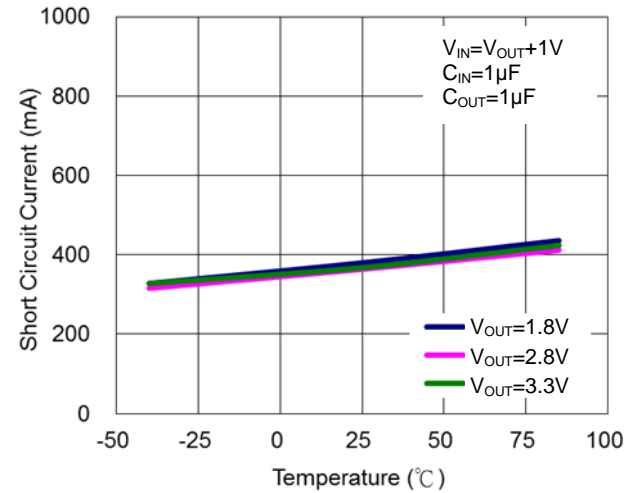

Typical Performance Characteristics (continued)

NEW PRODUCT

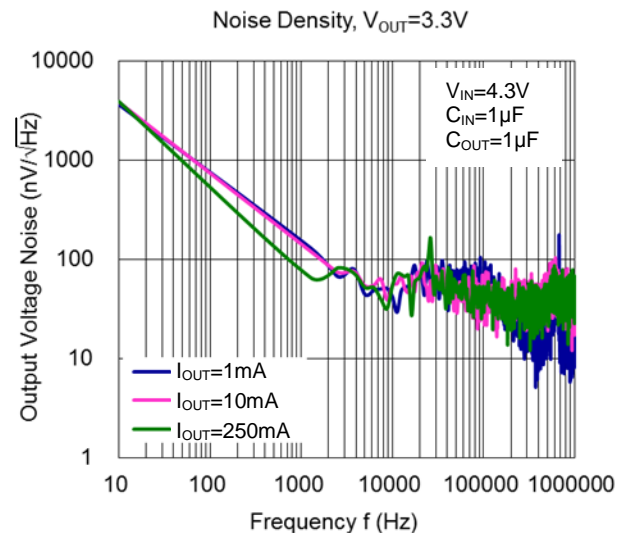
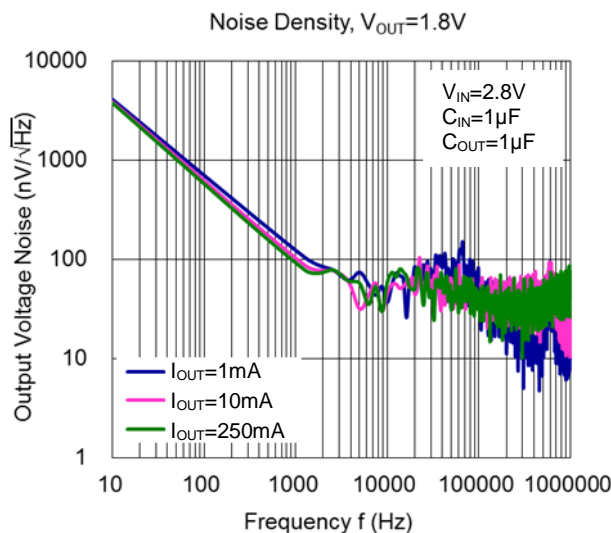
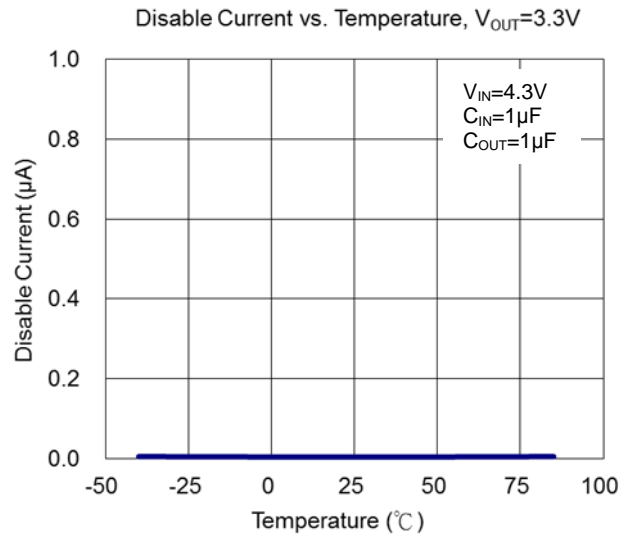
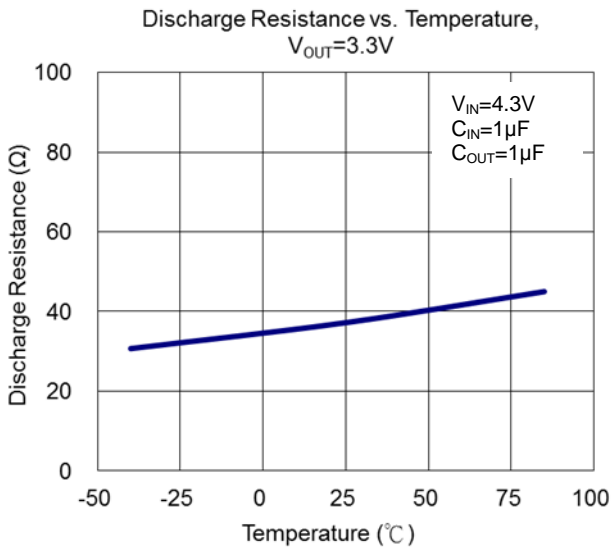
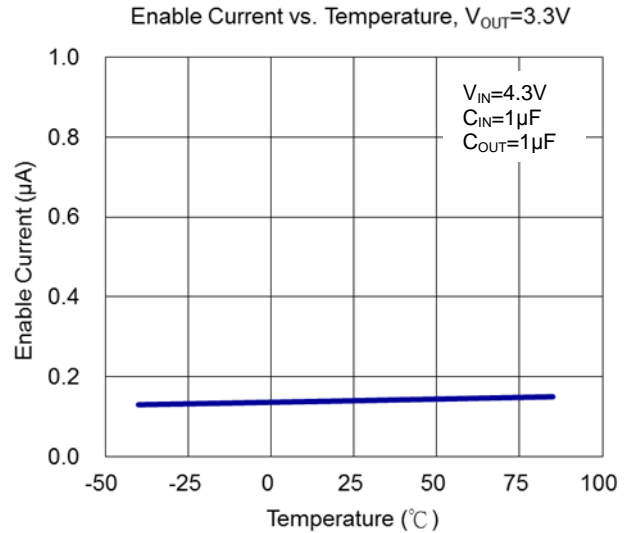
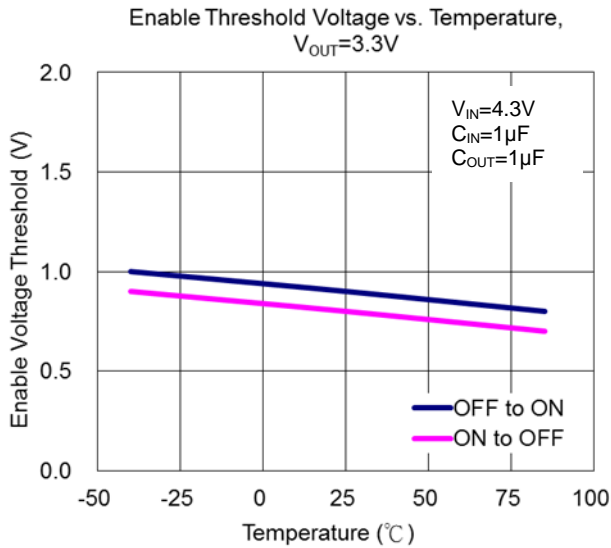

Typical Performance Characteristics (continued)

NEW PRODUCT

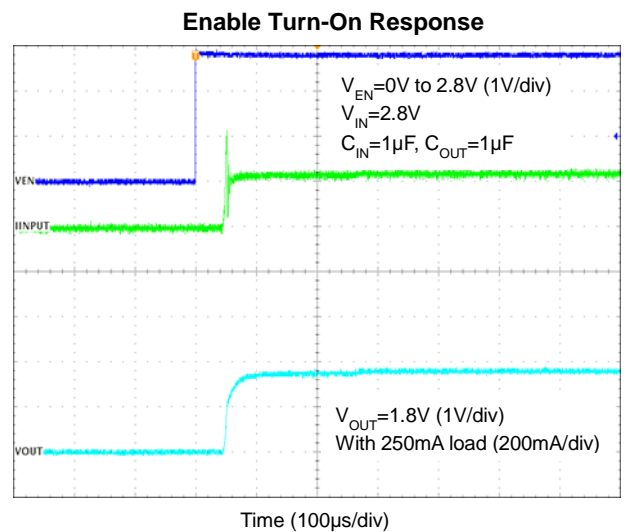
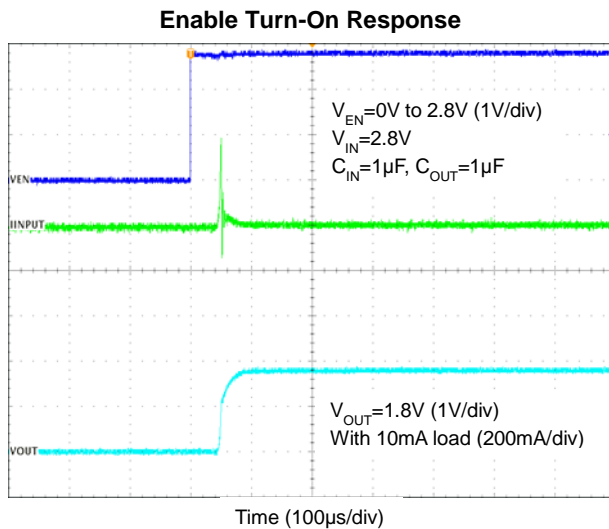
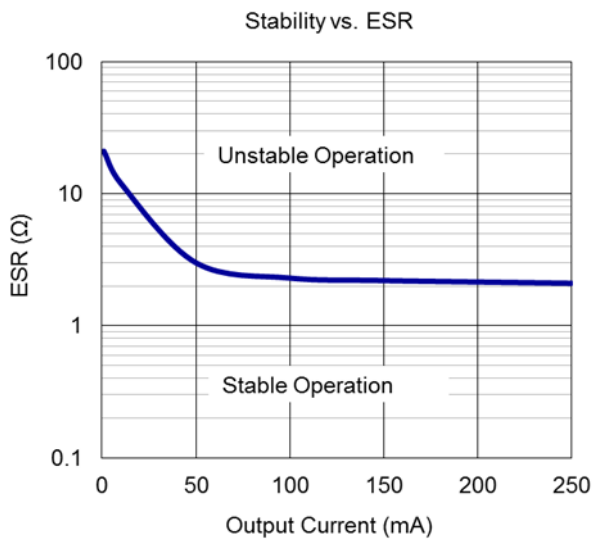
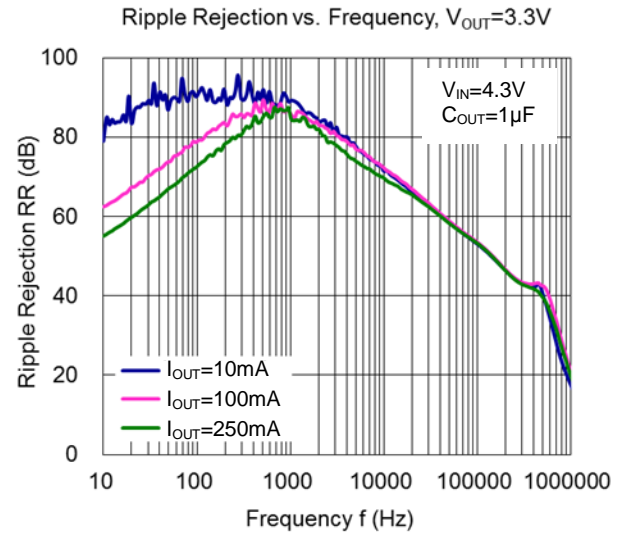
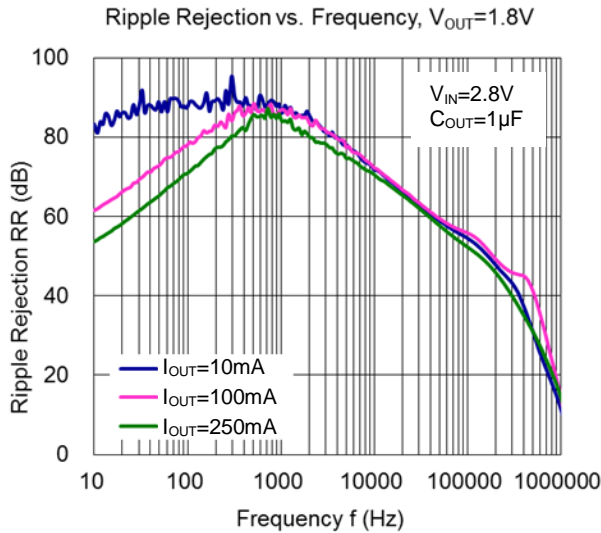

Typical Performance Characteristics (continued)

Line Transient Response

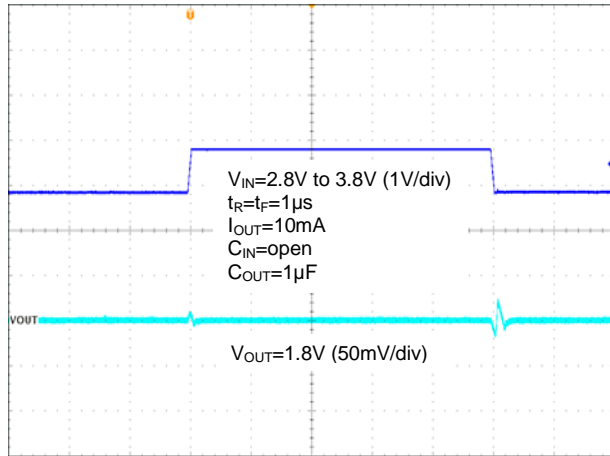

Time (40µs/div)

Line Transient Response

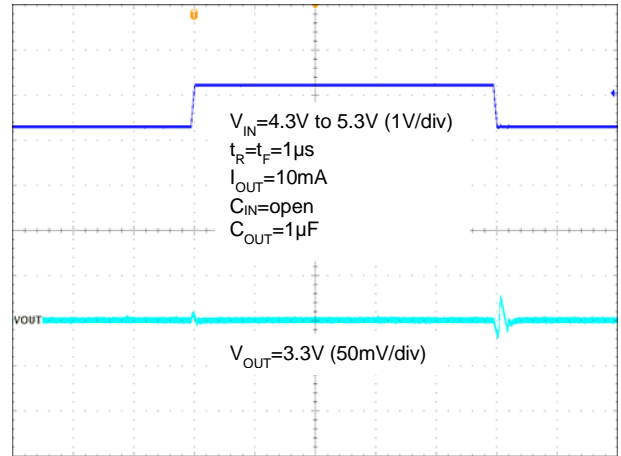

Time (40µs/div)

V_{IN} Slow Turn On

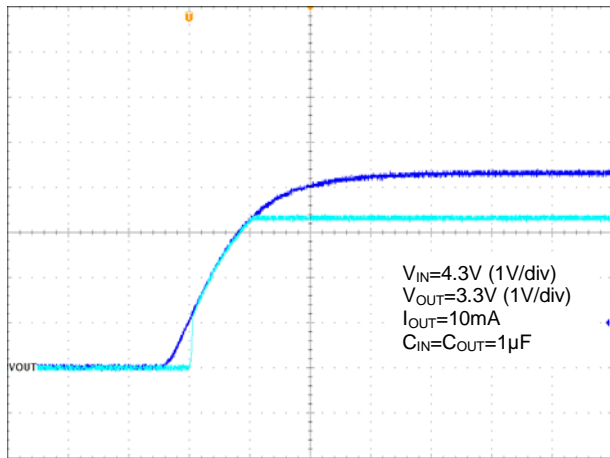

Time (4ms/div)

V_{IN} Slow Turn Off

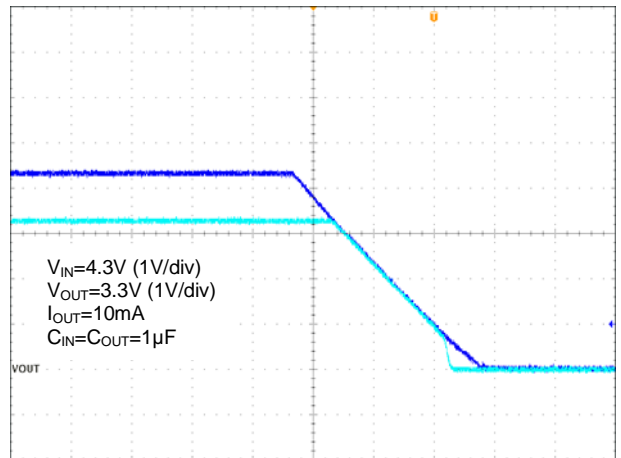

Time (4ms/div)

Load Transient Response

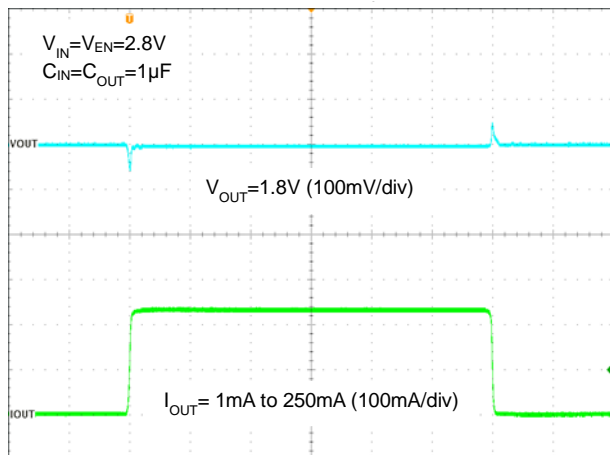

Time (20µs/div)

Load Transient Response

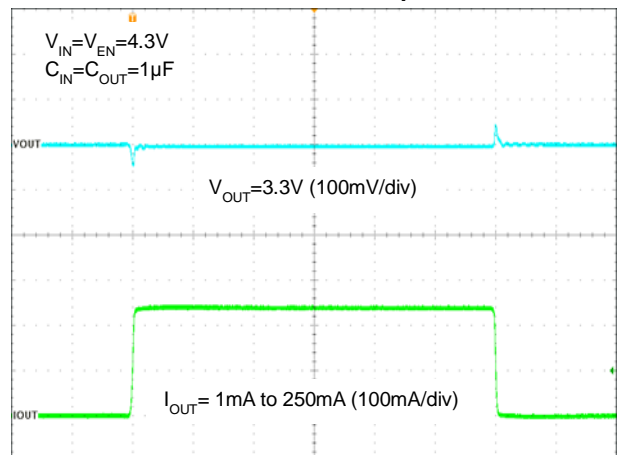

Time (20µs/div)

NEW PRODUCT

Typical Performance Characteristics (continued)

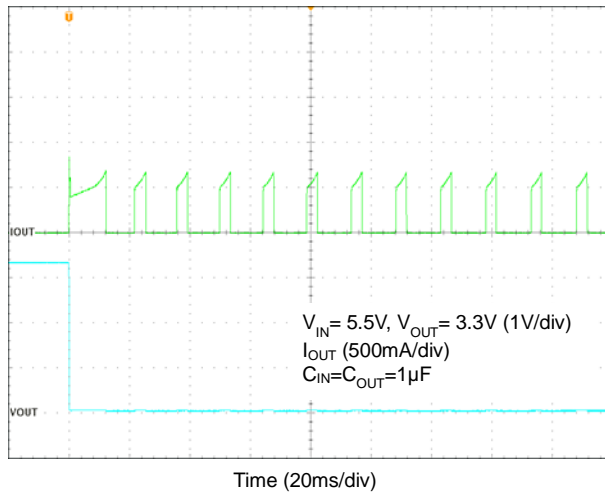
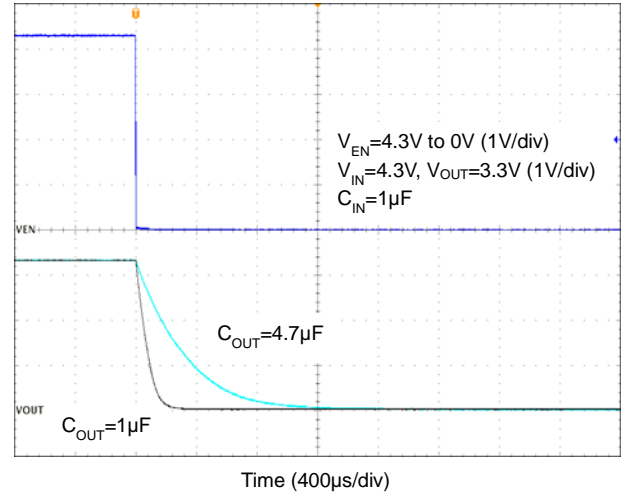
Short Circuit and Thermal Shutdown

Enable Turn-Off

NEW PRODUCT
Application Information
Over View

The AP7353 is a 250mA low dropout regulator, provides low noise, high PSRR, low quiescent current. With low quiescent current, this device is suitable for battery powered application and meets the requirements of RF applications and high performance analog circuits.

Output Capacitor

An output capacitor (C_{OUT}) is needed to improve transient response and maintain stability. The AP7353 is stable with very small ceramic output capacitors. The recommended capacitor value is 1µF with low temperature influence property such as X7R or X5R. The minimum effective capacitance to maintain AP7353 stable operation is 0.7µF which accounts for changes of temperature, DC bias and manufacturing tolerances. The ESR (equivalent series resistance) of C_{OUT} should lower than 2Ω. If the application has large load variations, it is recommended to utilize low-ESR bulk capacitors. It is recommended to place ceramic capacitors as close as possible to the OUT pin and the ground pin and care should be taken to reduce the impedance in the layout.

Input Capacitor

To prevent the input voltage from dropping during load steps, it is recommended to utilize an input capacitor (C_{IN}). A minimum 1µF ceramic capacitor is recommended between IN and GND pins to decouple input power supply glitch. This input capacitor must be located as close as possible to the device to assure input stability and reduce noise. For PCB layout, a wide copper trace is required for both IN and GND pins.

Enable Control

The AP7353 is turned on by setting the EN pin high, and is turned off by pulling it low. If this feature is not used, the EN pin should be tied to IN pin to keep the regulator output on at all time. To ensure proper operation, the signal source used to drive the EN pin must be able to swing above and below the specified turn-on/off voltage thresholds listed in the *Electrical Characteristics* section.

Short Circuit Protection

When OUT pin is short-circuit to GND, short circuit protection will be triggered and clamp the output current to approximately 350mA. This feature protects the regulator from overcurrent and damage due to overheating.

Layout Considerations

For good ground loop and stability, the input and output capacitors should be located close to the IN, OUT, and GND pins of the device. The regulator GND pin should be connected to the external circuit ground to reduce voltage drop caused by trace impedance. Ground plane is generally used to reduce trace impedance. Wide trace should be used for large current paths from V_{IN} to V_{OUT} , and load circuit.

Ordering Information

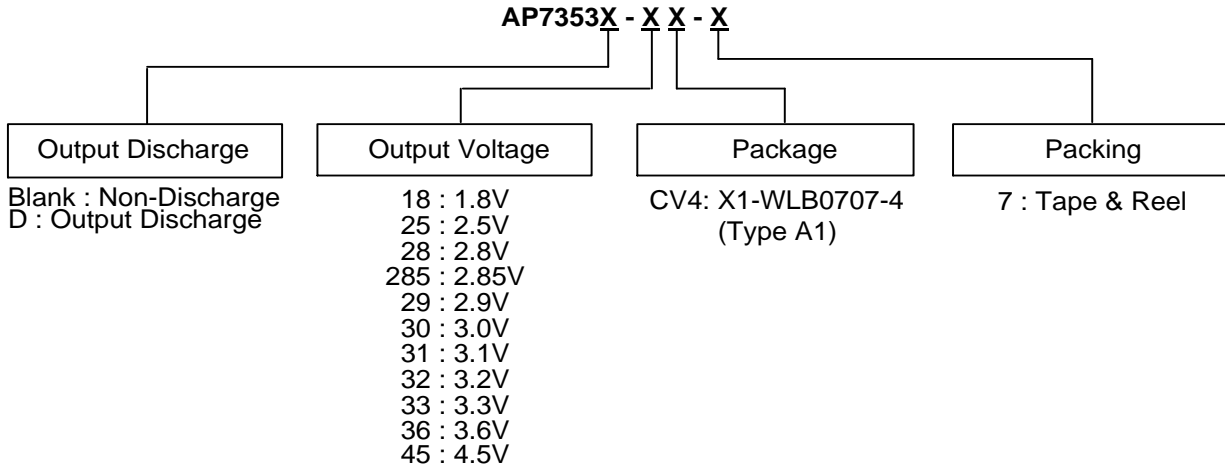

Part Number	Package Code	Packaging	7" Tape and Reel	
			Quantity	Part Number Suffix
AP7353-XXCV4-7	CV4	X1-WLB0707-4 (Type A1)	3,000/Tape & Reel	-7
AP7353-XXXCV4-7	CV4	X1-WLB0707-4 (Type A1)	3,000/Tape & Reel	-7
AP7353D-XXCV4-7	CV4	X1-WLB0707-4 (Type A1)	3,000/Tape & Reel	-7
AP7353D-XXXCV4-7	CV4	X1-WLB0707-4 (Type A1)	3,000/Tape & Reel	-7

NEW PRODUCT

Marking Information

(1) X1-WLB0707-4 (Type A1)

(Top View)

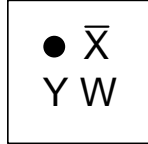

\bar{X} : Identification Code
 Y : Year : 0~9
 W : Week : A~Z : 1~26 week;
 a~z : 27~52 week; z represents
 52 and 53 week

Part Number	Package	Identification Code
AP7353-18CV4-7	X1-WLB0707-4 (Type A1)	\bar{D}
AP7353-25CV4-7	X1-WLB0707-4 (Type A1)	\bar{E}
AP7353-28CV4-7	X1-WLB0707-4 (Type A1)	\bar{F}
AP7353-285CV4-7	X1-WLB0707-4 (Type A1)	\bar{G}
AP7353-29CV4-7	X1-WLB0707-4 (Type A1)	\bar{H}
AP7353-30CV4-7	X1-WLB0707-4 (Type A1)	\bar{J}
AP7353-31CV4-7	X1-WLB0707-4 (Type A1)	\bar{K}
AP7353-32CV4-7	X1-WLB0707-4 (Type A1)	\bar{L}
AP7353-33CV4-7	X1-WLB0707-4 (Type A1)	\bar{M}
AP7353-36CV4-7	X1-WLB0707-4 (Type A1)	\bar{N}
AP7353-45CV4-7	X1-WLB0707-4 (Type A1)	\bar{P}
AP7353D-18CV4-7	X1-WLB0707-4 (Type A1)	\bar{R}
AP7353D-25CV4-7	X1-WLB0707-4 (Type A1)	\bar{S}
AP7353D-28CV4-7	X1-WLB0707-4 (Type A1)	\bar{T}
AP7353D-285CV4-7	X1-WLB0707-4 (Type A1)	\bar{U}
AP7353D-29CV4-7	X1-WLB0707-4 (Type A1)	\bar{V}
AP7353D-30CV4-7	X1-WLB0707-4 (Type A1)	\bar{W}
AP7353D-31CV4-7	X1-WLB0707-4 (Type A1)	\bar{X}
AP7353D-32CV4-7	X1-WLB0707-4 (Type A1)	\bar{Y}
AP7353D-33CV4-7	X1-WLB0707-4 (Type A1)	\bar{Z}
AP7353D-36CV4-7	X1-WLB0707-4 (Type A1)	$\bar{2}$
AP7353D-45CV4-7	X1-WLB0707-4 (Type A1)	$\bar{3}$

NEW PRODUCT

Package Outline Dimensions

Please see <http://www.diodes.com/package-outlines.html> for the latest version.

X1-WLB0707-4 (Type A1)

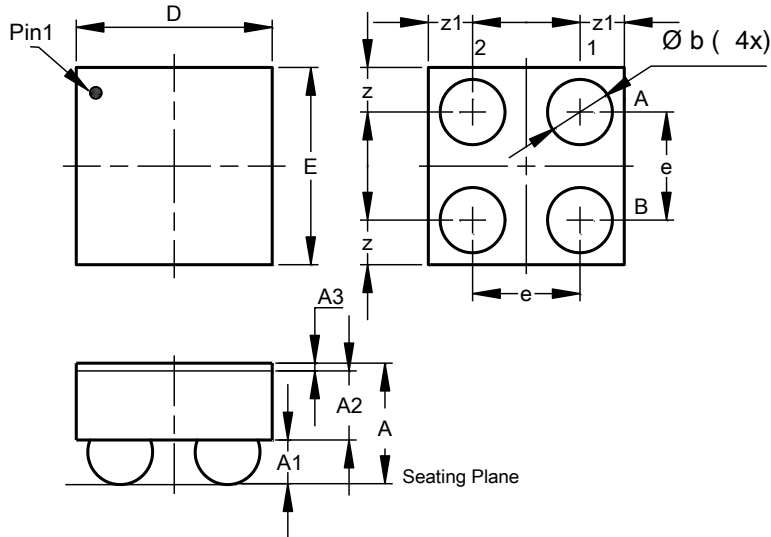

X1-WLB0707-4 (Type A1)			
Dim	Min	Max	Typ
A	0.345	0.445	0.395
A1	0.140	0.180	0.160
A2	0.185	0.235	0.210
A3	0.020	0.030	0.025
b	0.195	0.225	0.210
D	0.610	0.670	0.640
E	0.610	0.670	0.640
e	--	--	0.350
z	--	--	0.145
z1	--	--	0.145
All Dimensions in mm			

Suggested Pad Layout

Please see <http://www.diodes.com/package-outlines.html> for the latest version.

X1-WLB0707-4 (Type A1)

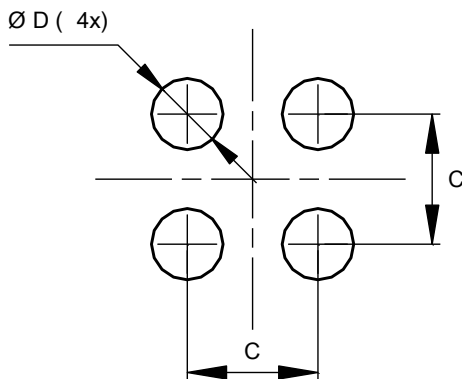

Dimensions	Value (in mm)
C	0.350
D	0.180

NEW PRODUCT

IMPORTANT NOTICE

DIODES INCORPORATED MAKES NO WARRANTY OF ANY KIND, EXPRESS OR IMPLIED, WITH REGARDS TO THIS DOCUMENT, INCLUDING, BUT NOT LIMITED TO, THE IMPLIED WARRANTIES OF MERCHANTABILITY AND FITNESS FOR A PARTICULAR PURPOSE (AND THEIR EQUIVALENTS UNDER THE LAWS OF ANY JURISDICTION).

Diodes Incorporated and its subsidiaries reserve the right to make modifications, enhancements, improvements, corrections or other changes without further notice to this document and any product described herein. Diodes Incorporated does not assume any liability arising out of the application or use of this document or any product described herein; neither does Diodes Incorporated convey any license under its patent or trademark rights, nor the rights of others. Any Customer or user of this document or products described herein in such applications shall assume all risks of such use and will agree to hold Diodes Incorporated and all the companies whose products are represented on Diodes Incorporated website, harmless against all damages.

Diodes Incorporated does not warrant or accept any liability whatsoever in respect of any products purchased through unauthorized sales channel. Should Customers purchase or use Diodes Incorporated products for any unintended or unauthorized application, Customers shall indemnify and hold Diodes Incorporated and its representatives harmless against all claims, damages, expenses, and attorney fees arising out of, directly or indirectly, any claim of personal injury or death associated with such unintended or unauthorized application.

Products described herein may be covered by one or more United States, international or foreign patents pending. Product names and markings noted herein may also be covered by one or more United States, international or foreign trademarks.

This document is written in English but may be translated into multiple languages for reference. Only the English version of this document is the final and determinative format released by Diodes Incorporated.

LIFE SUPPORT

Diodes Incorporated products are specifically not authorized for use as critical components in life support devices or systems without the express written approval of the Chief Executive Officer of Diodes Incorporated. As used herein:

A. Life support devices or systems are devices or systems which:

1. are intended to implant into the body, or
2. support or sustain life and whose failure to perform when properly used in accordance with instructions for use provided in the labeling can be reasonably expected to result in significant injury to the user.

B. A critical component is any component in a life support device or system whose failure to perform can be reasonably expected to cause the failure of the life support device or to affect its safety or effectiveness.

Customers represent that they have all necessary expertise in the safety and regulatory ramifications of their life support devices or systems, and acknowledge and agree that they are solely responsible for all legal, regulatory and safety-related requirements concerning their products and any use of Diodes Incorporated products in such safety-critical, life support devices or systems, notwithstanding any devices- or systems-related information or support that may be provided by Diodes Incorporated. Further, Customers must fully indemnify Diodes Incorporated and its representatives against any damages arising out of the use of Diodes Incorporated products in such safety-critical, life support devices or systems.

Copyright © 2019, Diodes Incorporated

www.diodes.com