

Sealed Industrial Circular Ethernet IP67 Duplex LC Connector System Assembly Instructions

CONEC Industrial Ethernet Circular Sealed LC Connector System consists of a **Duplex LC Plug Kit**, a **Protective Cap Assembly** for Duplex LC Plug, a **Duplex LC Receptacle Kit**, and a **Protective Cover Assembly** for Duplex LC Adaptor.

1. The Duplex LC Plug Kit

1.1 Introduction

The Duplex LC plug kit consists of 2 **Duplex LC Connectors with Dust Caps**, 2 **Crimp Barrels**, a **Duplex LC Clip** and a **Plug Housing Assembly (Bayonet)**. There are 2 different versions available for the **Plug Housing Assembly**, plastic and Zinc Die-cast. See Figure 1-1 for details.

Figure 1-1: Duplex LC Plug Kit

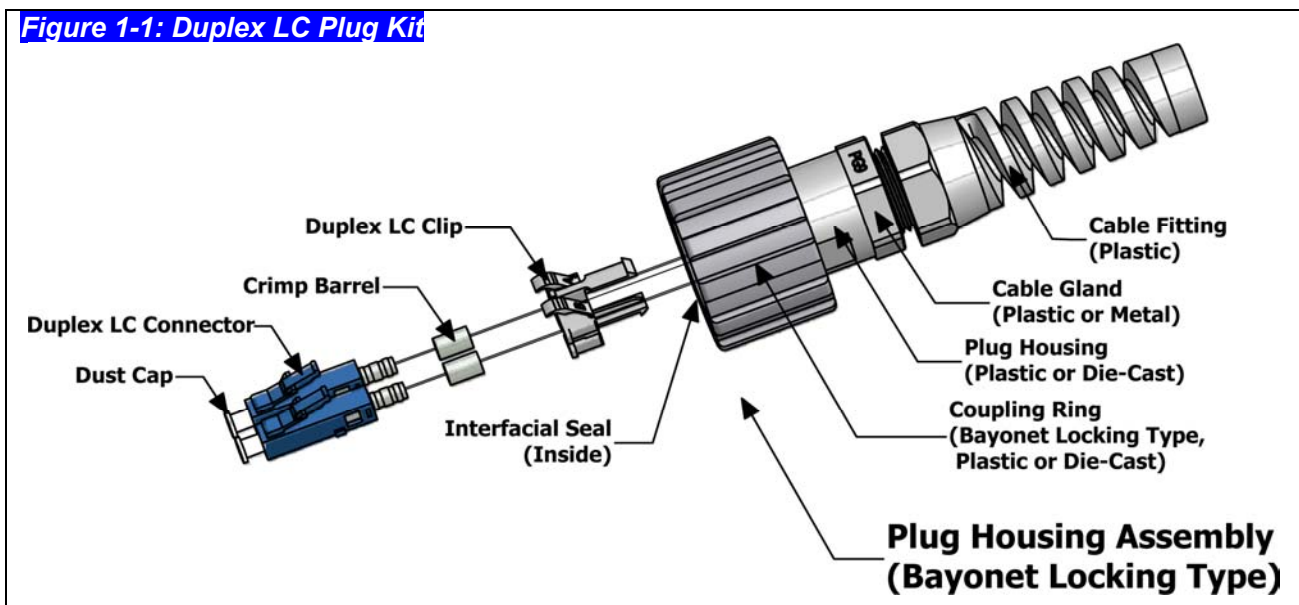

Plastic Version Single Mode (SM)	P/N: 17-300030
Plastic Version Multi Mode (MM)	P/N: 17-300040
Zinc Die-cast Version Single Mode (SM)	P/N: 17-300080
Zinc Die-cast Version Multi Mode (MM)	P/N: 17-300090

1.2 Assembly Procedure

The sealed circular LC connector accepts outdoor fiber optical cable, with a 4.5mm – 8.0mm outside diameter and a pair of 2.0mm jacketed subunits.

1.2.1 Cable Preparation

Step1: Slide the plug assembly over the fiber optic cable as shown in Figure 1-2-1.

Figure 1-2-1: Slide the Plug Assembly over the Cable Jacket



Step3: Cable should be stripped and cut with the proper tools to the correct length as shown in Figure 1-2-2.

Figure 1-2-2: Recommended Dimensions of the Stripped Cable

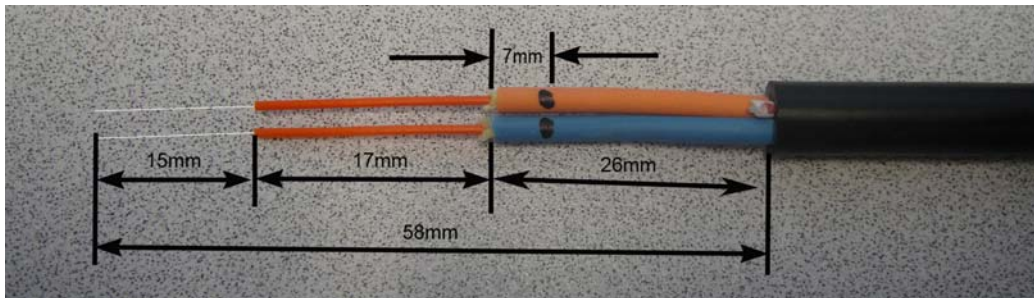

Step2: Using sharp scissors carefully cut 2 slits on each jacket of the subunit see Figure 1-2-3.

Figure 1-2-3: Cut the jacket of the subunits

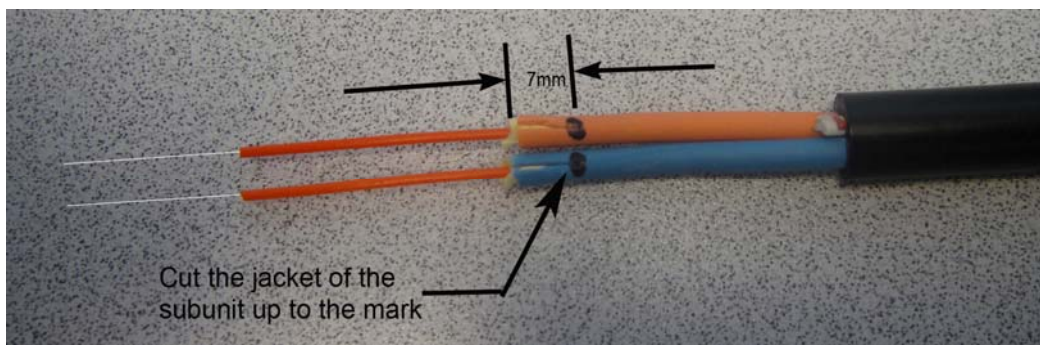

1.2.2 Connector Termination

Step1: Prepare the Epoxy according to the manufacturer's instructions.

Step2: Fill the syringe with epoxy and remove any air bubbles.

Note: Do not exceed the pot life of the epoxy recommended by the manufacturer.

Step3: Wipe clean the needle tip before applying the epoxy.

Step4: Inject epoxy into the body by inserting the epoxy needle up to the back of the ferrule inside the body.

Note: Hold the body with the ferrule pointing up.

Step5: Press the syringe plunger gently until a very small bead of epoxy appears on the tip of the ferrule.

Step6: Wipe Excess epoxy off the tip with a wipe.

Note: Be careful not to get excess epoxy between the plastic guide tube and the body, as this will cure in the oven and stop the spring from compressing.

Step7: Slightly pull back the needle inside the body by 1mm and inject another small amount of epoxy to the back of the ferrule.

Step8: Place the crimp barrel over the subunit cables. See Figure 1-2-4.

Step9: Insert the optical fiber into the back of the body.

Note: Be careful not to break the fiber, insert the fiber slowly until the fiber guide tube is located, and then fully insert the fiber into the body.

Step10: After the fiber has been inserted into the connector ferrule, carefully slide the crimp barrel rearward to unfurl the slit jacket and the strength members, making sure the aramid strength member is evenly distributed. See Figure 1-2-4.

Figure 1-2-4: Place the crimp barrel on the proper position

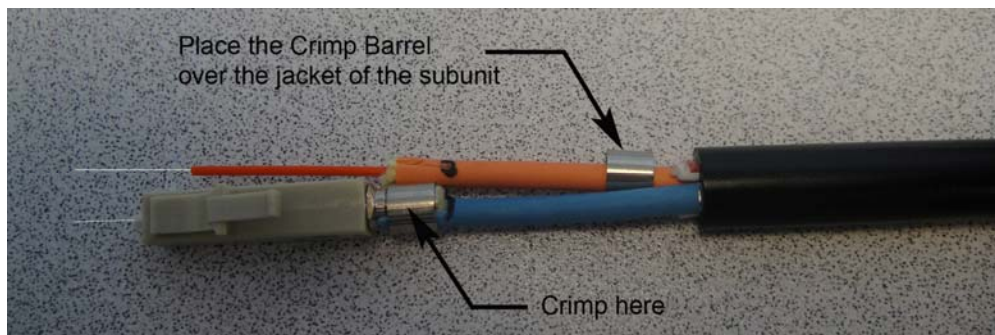

Step11: Properly crimp the crimp barrel using size 3.6mm crimp tool set see Figure 1-2-5.

Figure 1-2-5: Crimp the barrel over the slit jacket of the subunit

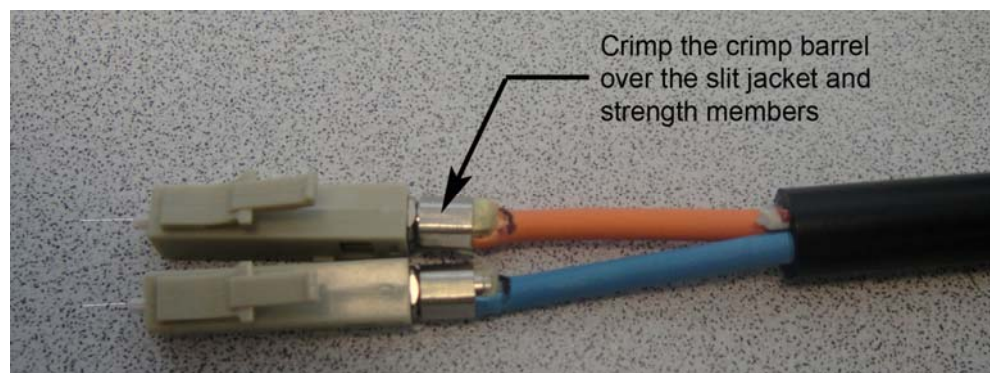

1.2.3 Curing the Epoxy

Step1: Using a suitable curing oven to cure the epoxy.

Step2: Gently place the assembly into the oven and cure for the specified time described by the manufacturer.

Step3: When connectors are fully cured, remove from the oven, cool down to room temperature.

1.2.4 Cleaving of the Fiber

Step1: After connectors have cooled to room temperature, use a suitable cleave tool e.g. (Diamond tip, Sapphire, Tungsten Carbide Pen type), remove the excess fiber protruding the tip of the ferrule.

Note: This is achieved by holding the ferrule with the fiber pointing upwards.

Step2: Rest the blade of the cleave tool against the fiber just on top of the epoxy bead on the surface of the ferrule.

Step3: Gently run the full length of the blade over one side of the fiber.

Note: Be careful not to knock the fiber off with the cleave tool.

Step4: Remove the excess fiber by running your thumb and finger up the length of the fiber, without forcing the fiber to break off. The fiber should fall away from the assembly.

Step5: Place fiber off-cuts in a suitable sharps bin for proper disposal.

Step6: When all fiber has been removed, check the sides of the ferrule for any excess epoxy that may have cured. If this is the case, use a scalpel or stanley blade to remove the excess.

Note: Please do not break the exposed fiber when processing steps given above.

1.2.5 Polishing

If Telcordia GR-326-CORE type end face criteria and performance are to be achieved it is advisable to use proper polishing machine and polishing consumables. For polishing procedures.

1.2.6 End Face Inspection

Caution: Optical fibers may emit radiation if the far end is connected with a working laser or light emitting diode (LED). Never view the fiber end of the cable or plug with the naked eye or any optical instrument until absolute verification is established that the

fiber is disconnected from any laser or LED source. Check the polished end face of the ferrule using a microscope or a magnifier.

Note: There should be no scratches or cracks. See Figure 1-2-6.

Figure 1-2-6: Fiber Polishing Inspection

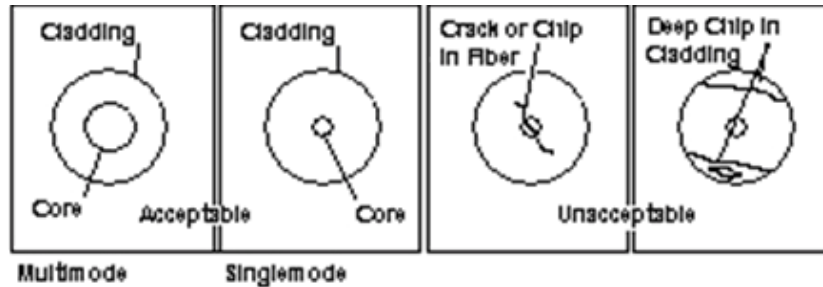

1.2.7 Cleaning Procedure

Step1: Wipe the ferrule surface with IPA (Isopropyl Alcohol) soaked Kimwipes.

Step2: Clean the inside of the dust cap before putting it on the ferrule.

Note: Cleaning should be done thoroughly, since it affects the connection characteristics of plugs.

Step3: Place the dust cap over the ferrule. See Figure 1-2-7.

Figure 1-2-7: Place the Dust Cap over the Ferrule

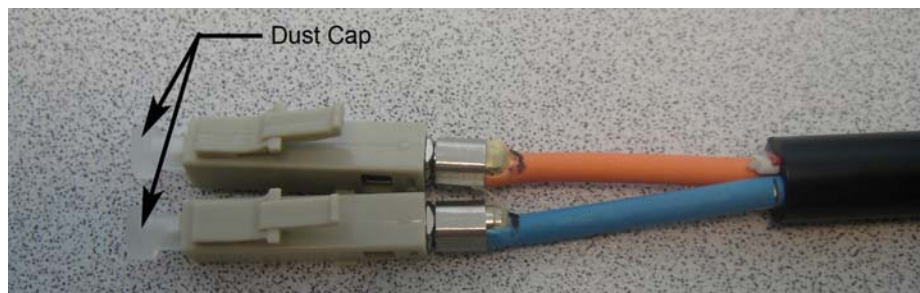

1.2.7 Assembly of duplex LC connector and the LC clip

Figure 1-2-8: Inside Edges of the Duplex LC Clip

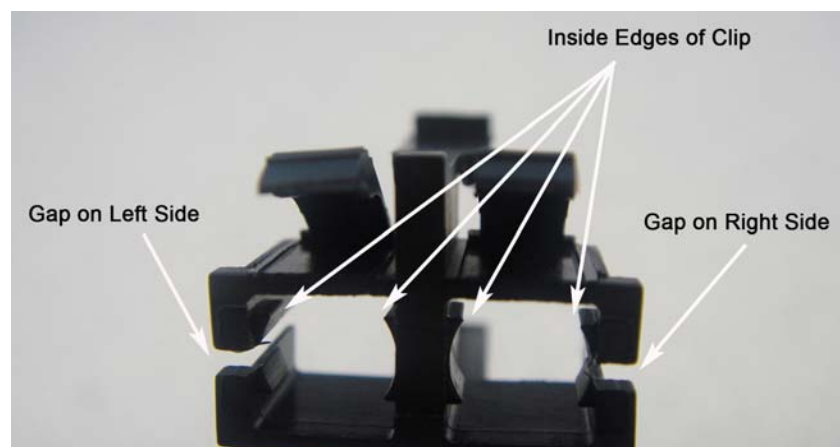

Step1: Push the subunits of the fiber optic cable into the duplex LC clip through the gap (shown on Figure 1-2-8) on both sides of the clip as shown on Figure 1-2-9.

Figure 1-2-9: Push the Subunit into the Clip through the gap

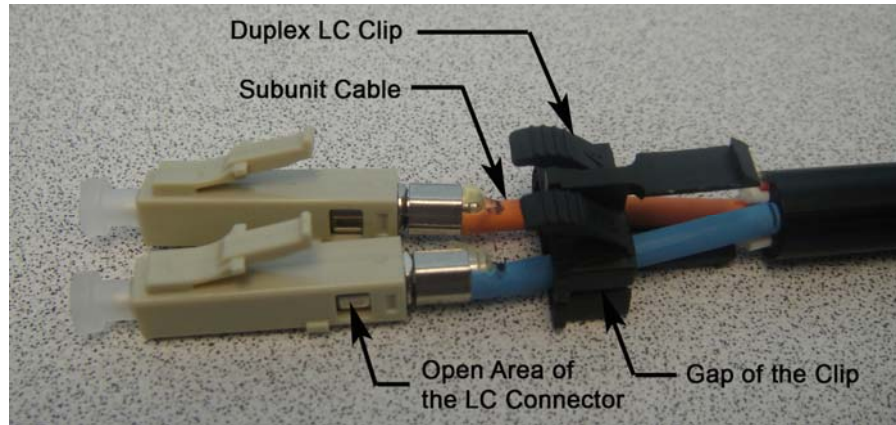

Step2: Gently rotate the LC connector (see Figure 1-2-10) slightly in both directions to place the LC connector into the proper position of the cavity of the duplex LC clip, make sure that all edges of inside clip (see Figure 1-2-8) are completely seated into the open area of the duplex LC connector. Figure 1-2-11 shows the assembled LC connector.

Figure 1-2-10: Gently Rotate the LC Connector to place it into the LC Clip

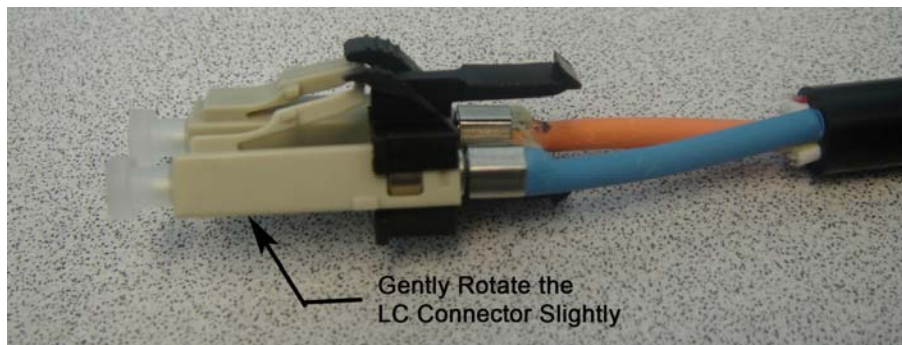
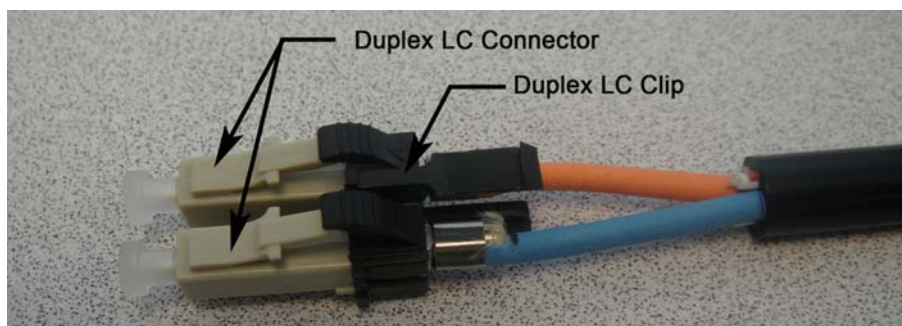

Figure 1-2-11: The Assembled LC Connector



1.2.3 Push the Assembled Duplex LC Connector into the Plug Housing

Line up the top latch of the LC clip to the latch slot of the plug housing (see Figure 1-2-9 for details). Depress both latches of the clip and push the assembled LC connector into the plug housing. An audible “click” is heard when the assembled connector is seated properly into the plug housing as shown in Figure 1-2-14.

Figure 1-2-12: Line up the top latch of the Clip to Latch Slot of the Plug Housing

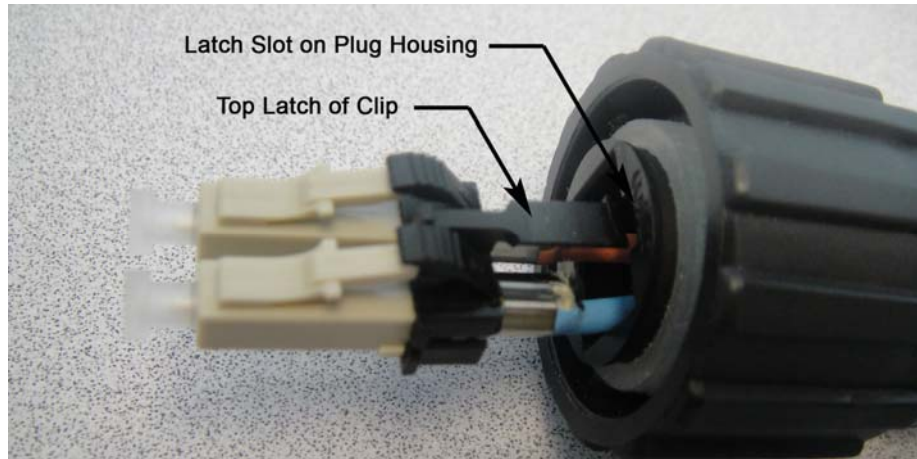

1.2.4 Tightening the Cable Fitting

Using two 19mm wrenches tighten the cable fitting to a torque value of 0.68 – 0.90 Nm (6.0 – 8.0 lb-in). See Figure 1-2-13. The finished Plug assembly is shown in Figure 1-2-14.

Figure 1-2-13: Tight the Cable Fitting



Figure 1-2-14: Finished Assembly of Duplex LC Plug

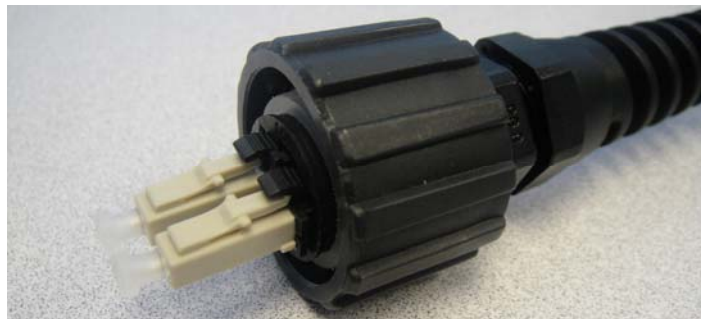

2. The Plug Protective Cover Assembly

2.1 Introduction

The Plug Protective Cover Assembly consists of a **Plug Protective Cover** and a **Tether**. There are 2 different versions available for the Plug Protective Cover Assembly; a plastic version and a metallized plastic version. Figure 2-1 shows the details.

Figure 2-1: The Plug Protective Cover Assembly

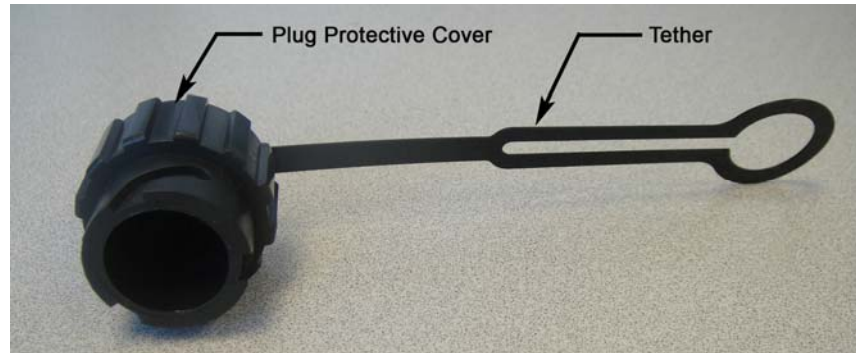

Plastic Version	P/N: 17-300050
Metallized Plastic Version	P/N: 17-300100

2.2 Assembly of the Plug Protective Cover Assembly

Step1: Open the loop on the tether and slid it over the Coupling Ring.

Step2: push the tether over the Coupling Ring and place the tether into the groove between the cable gland and cable fitting.

Step3: Engage the Plug Protective Cover with the Plug Assembly properly as shown on Figure 2-2

Figure 2-2: Engagement of the Plug Protective Cover and Plug Assembly

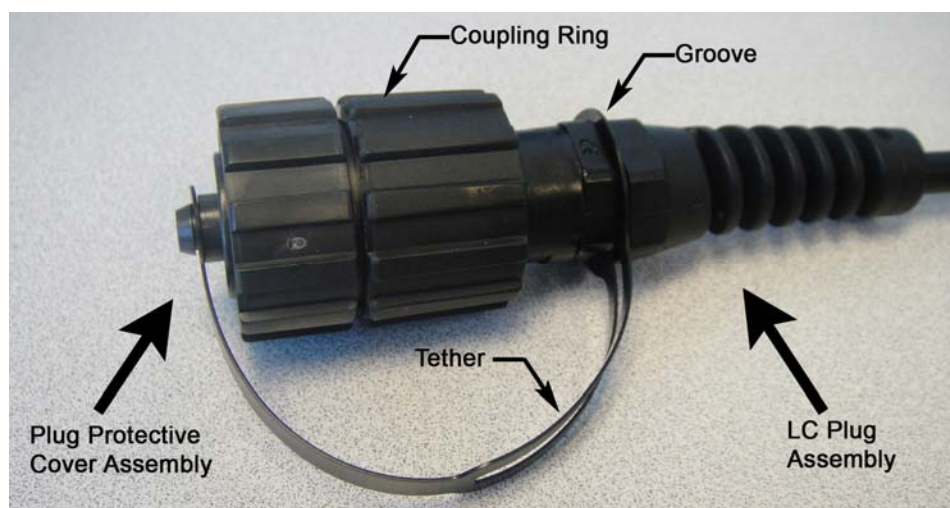

3. The Duplex LC Receptacle Assembly Kit

3.1 Introduction

The Duplex LC Receptacle Assembly Kit consists of a **Duplex LC Receptacle Assembly**, a **Panel Gasket** and a **Panel Nut**. There are 2 different versions available for the LC receptacle assembly kit, plastic version and Zinc Die-cast version. Details are shown in Figure 3-1.

Figure 3-1: Duplex LC Receptacle Assembly Kit

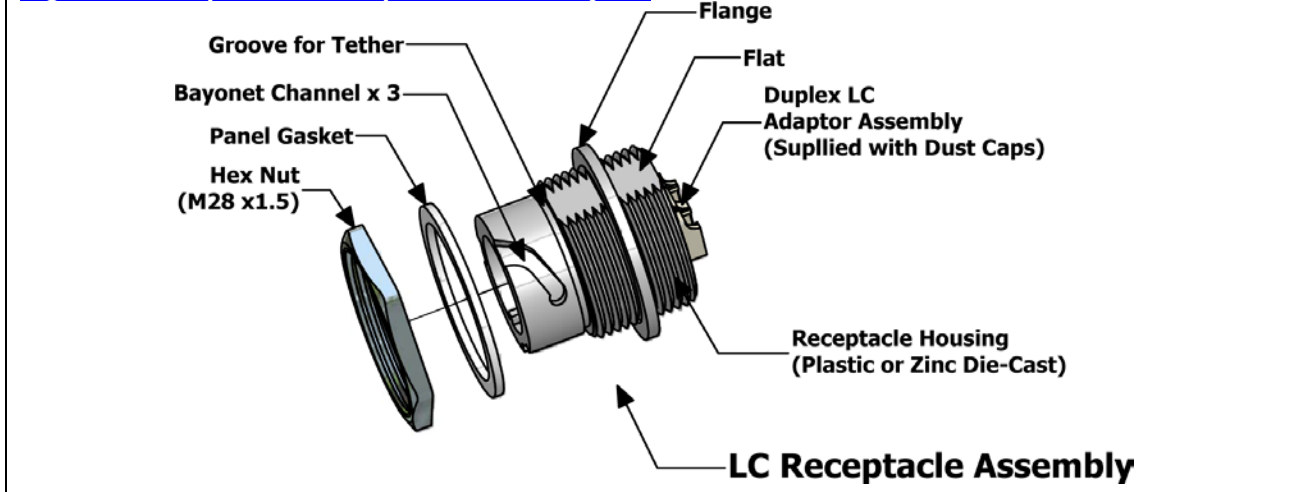

Plastic Version Single Mode (SM)	P/N: 17-300010
Plastic Version Multi Mode (MM)	P/N: 17-300020
Zinc Die-cast Version Single Mode (SM)	P/N: 17-300060
Zinc Die-cast Version Multi Mode (MM)	P/N: 17-300070

4. The Receptacle Protective Cover Assembly

4.1 Introduction

The Protective Cover Assembly consists of a **Receptacle Protective Cover**, a **Cover Gasket** and a **Tether** or a **Ball Chain with Metal Ring**. There are 2 different versions available for the **Protective Cover Assembly**, plastic version (shown on Figure 4-1) and Zinc Die-Cast version (shown on Figure 4-2).

Figure 4-1: The Plastic Version Receptacle Protective Cover Assembly



Plastic Version Receptacle Protective Cover Assembly	P/N: 17-10002
--	---------------

Figure 4-2: The Zinc Die-Cast Version Receptacle Protective Cover Assembly

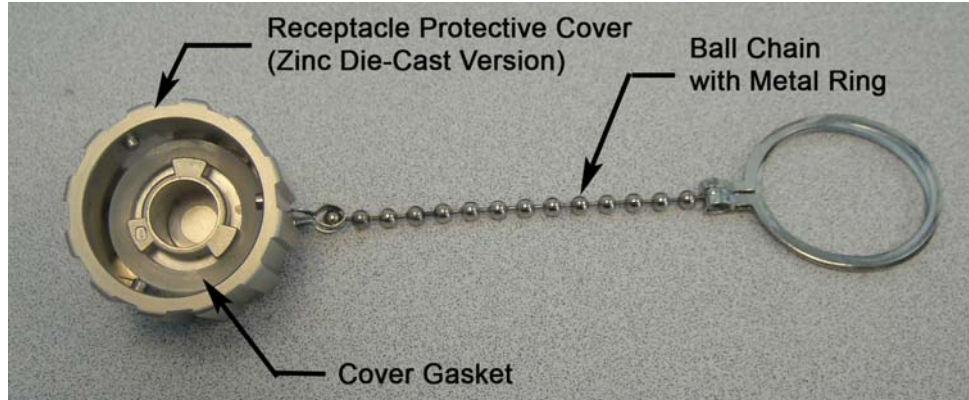

Zinc Die-Cast Version Receptacle Protective Cover Assembly

P/N: 17-101800

5 Panel Cutout

5.1 Introduction

A panel thickness of up to 3.20 mm may be used. The recommended panel cutout dimension for plastic, metallized plastic and metal versions are shown in Figure 5-1 while Figure 5-2 is the recommended panel cutout dimension for zinc die-cast version and Figure 5-3 is the recommended panel cutout dimension for flange mount zinc die-cast version.

Figure 5-1: Recommended Panel Cutout for Plastic, Metallized Plastic and Metal Version

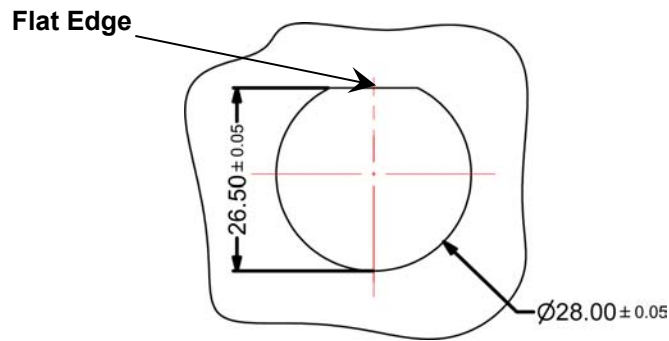

Figure 5-2: Recommended Panel Cutout for Zinc Die-Cast Version

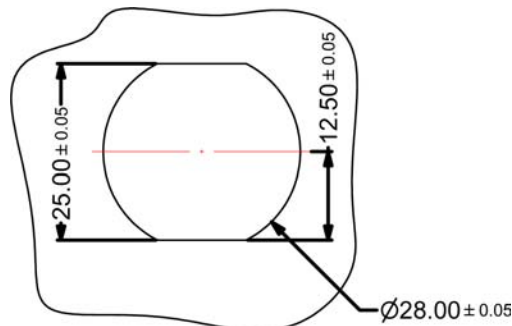
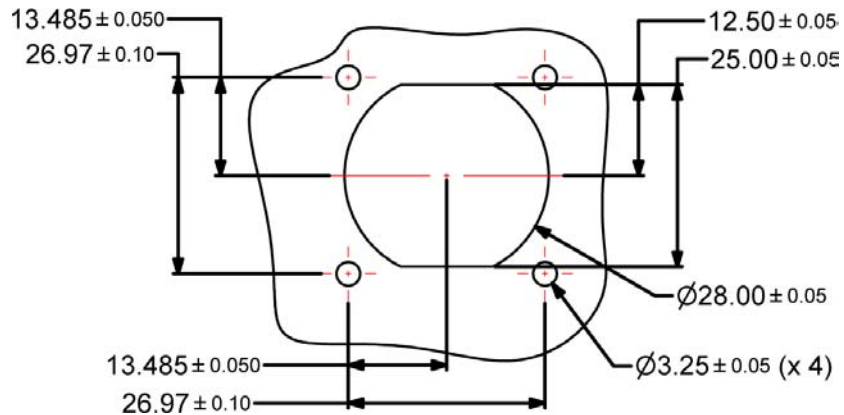

Figure 5-3: Recommended Panel Cutout for Flange Mount Zinc Die-Cast Version



5.2 Panel Mounting

The receptacle is designed for front or rear panel mounting as shown in Figure 5-2 and Figure 5-3. The panel nut should be tightened to a torque of 2.27 Nm (20 lb-in).

The **Protective Cover** must be installed onto the **Receptacle Assembly** to ensure IP67 sealing performance after the **Plug Assembly** has been removed from the receptacle.

Figure 5-2: The Rear Panel mount



Figure 5-3: The Front Panel mount



6 The Connector Engagement

6.1 Duplex LC Plug and Receptacle Adaptor Engagement (Bayonet)

Gently insert the assembled LC plug (Bayonet) into the LC receptacle adaptor, align the 3 keys of the bayonet coupling ring with 3 bayonet channels of the receptacle and rotate the bayonet coupling ring until the 3 keys “click” into the bayonet channels. See Figure 6-1.

Figure 6-1: The LC Plug and Receptacle Adaptor Engagement

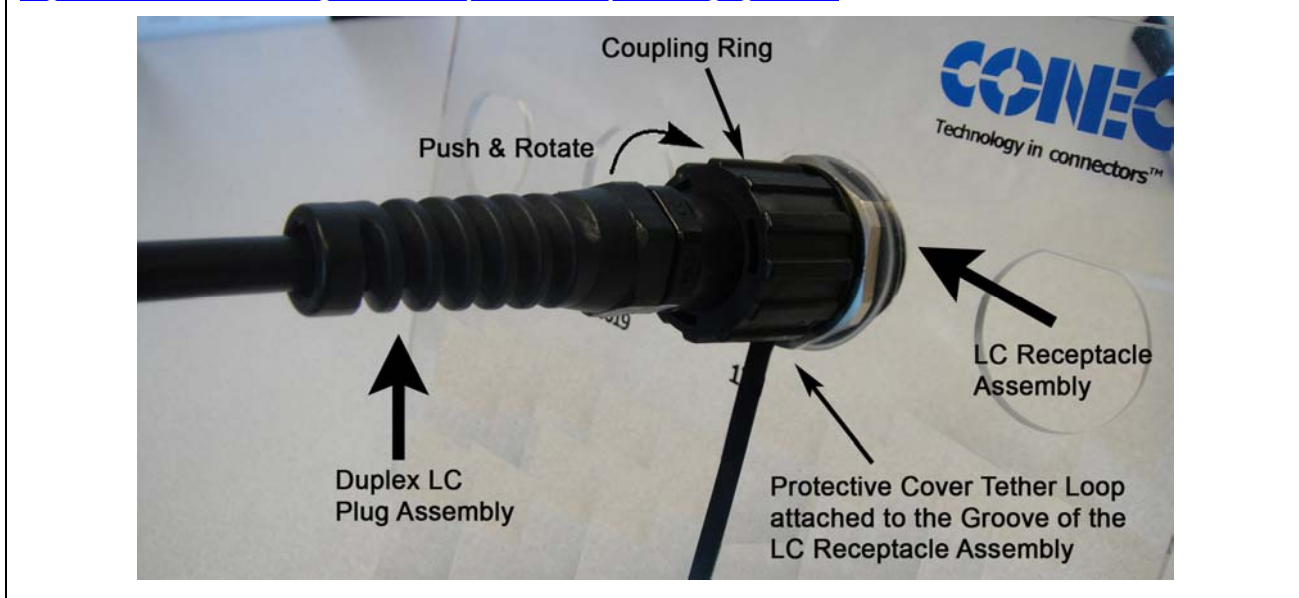

6.2 Receptacle Protective Cover Engagement

The Receptacle protective cover must be installed onto the **LC Receptacle Assembly** and engaged with the receptacle immediately for insuring IP67 sealing performance whenever the **LC Plug Assembly (Bayonet)** is removed from the **LC Receptacle Assembly**.

The tether of the receptacle protective cover should be attached to the **LC Receptacle Assembly** if it is to be used. Place the loop of the tether in the groove (located between the end of the bayonet channels and the hex nut) of the **LC Receptacle Assembly**. See Figure 6-2.

Figure 6-2: The Cover and Receptacle Adaptor Engagement

