

POLARIZATION OPTION A
P/N: 31372-1000

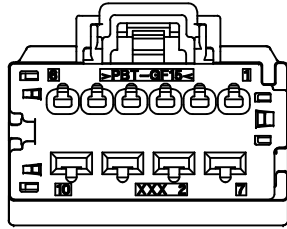

POLARIZATION OPTION B
P/N: 31372-1100

MOLEX ASSEMBLY PART NO.'S	MATING COMPONENT	
	VERTICAL HEADER	RIGHT ANGLE HEADER
31372-1000	34695-0100	34696-0100
31372-1100	34695-0101	34696-0101

ITEM	DESCRIPTION	COLOR	MOLEX COMPONENTS PART NO.	RECYCLING CODE	WEIGHT	NO OF ITEMS REQUIRED
1	FEMALE HOUSING POL A	BLACK	31372-2000	SPS/PA66-GF30	6.74g	1
2	FEMALE HOUSING POL B	GRAY	31372-2100	SPS/PA66-GF30	6.73g	1
3	TPA	NATURAL	31372-3000	PBT-GF15	1.39g	1

APPLICABLE COMPONENTS			APPLICABLE WIRE SIZE		
ITEM	DESCRIPTION	TYPE	SUPPLIER COMPONENTS PART NO.	WIRE GAGE	MAXIMUM INSULATION DIAMETER
1	MOLEX MX150 TERMINAL	Sn	33012-2001	14/16 AWG	2.70mm
2		Sn	33012-2002	18/20 AWG	2.54mm
3		Sn	33012-2003	22 AWG	1.70mm
4		Sn	33012-3001	14/16 AWG	2.70mm
5		Sn	33012-3002	18/20 AWG	2.54mm
6		Sn	33012-3003	22 AWG	1.70mm
7	TYCO 2.8 TERMINAL	Sn	1326030-4	10/12 AWG	4.04mm
8		Sn	1326030-3	14/16 AWG	2.69mm
9		Sn	1326030-2	18/20 AWG	2.06mm
10	YAZAKI 2.8 TERMINAL	Sn	1326030-1	22 AWG	1.65mm
8		Sn	7116-4112-02	14 AWG	2.69mm
9		Sn	7116-4111-02	16/18 AWG	2.34mm
10	Sn	7116-4110-02	20/22 AWG	1.85mm	

NOTES: VALID UNLESS OTHERWISE SPECIFIED

1. GENERAL:

- a. APPLICATION SPECIFICATION SEE: AS-31372-100
- b. PRODUCT SPECIFICATION SEE: PS-31372-100
- c. PACKAGING SPECIFICATION PER MOLEX DRAWING: PK-31300-931
- d. PARTS MUST BE IN COMPLIANCE TO MOLEX CHEMICAL SUBSTANCES FOR PRODUCTS AND PACKAGING SPECIFICATION: PS-40000-5015
- e. DATA MUST BE SUBMITTED UNDER THE MOLEX PART NUMBER TO IMDS (COMPANY ID#13255)

2. DESIGN - MATERIALS:

- a. SEE BOM TABLE

3. DESIGN - GEOMETRY:

- a. THIS IS A 100% CAD GENERATED PART. THE CAD MATHEMATICAL DATA IS THE MASTER FOR THIS PART. FOR DIMENSIONAL OR ANY INFORMATION NOT SHOWN ON THIS DRAWING, ANALYZE THE CAD MODEL.
- b. GEOMETRIC DIMENSIONS AND TOLERANCES PER ASME Y14.5M - 1994
- c. EDGES AND UNDIMENSIONED DETAILS PER ISO13715
- d. CORNERS SHOWN AS SHARP TO BE R 0.2 MAX.
- e. LETTERING SHALL BE 0.15 MAX RAISED IN 0.25 MAX RECESS PAD. THIS INCLUDES RECYCLING CODE, CAVITY ID, VENDOR IDENTIFICATION, AND CUSTOMER MATERIAL NUMBER.
- f. VISUAL DEFECTS SHALL MEET COSMETIC STANDARD PS-45499-002 (Class B)

4. DESIGN - MANUFACTURING:

- a. TPAs MAY BECOME SEATED DURING TRANSIT. IF THIS OCCURS, REFERENCE MOLEX PRODUCT SPECIFICATION PS-34646-001

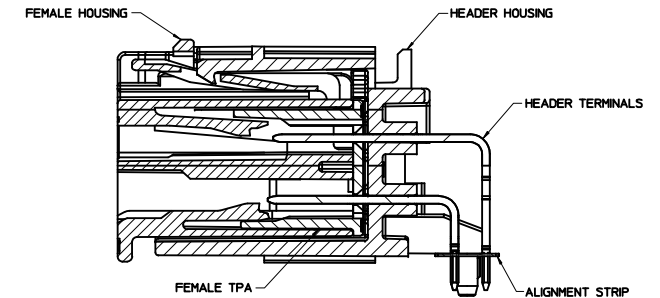

ASSEMBLY SECTION

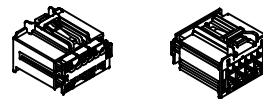

ISOMETRIC VIEWS
SCALE 1:1
(POLARITY A SHOWN)

CAPACITY TOOLING EC NO: UAU2009-1196 2009/06/04 DRAWN/DANIELE CHKD/BOICK 2009/06/04 APPR/SMARCEAU 2009/06/04	QUALITY SYMBOLS ▽=0 ▽=0	GENERAL TOLERANCES (UNLESS SPECIFIED) mm INCH 4 PLACES ±--- ±--- 3 PLACES ±--- ±--- 2 PLACES ±0.13 ±--- 1 PLACE ±0.25 ±--- ANGULAR ± 1°	DIMENSION STYLE MM ONLY DRAWN BY DATE SKAROLEW 04/07/2003 CHECKED BY DATE MDANIELS 04/07/2003 APPROVED BY DATE BBWILSON 04/08/2003	SCALE 4:1 DESIGN UNITS METRIC THIRD ANGLE PROJECTION	TITLE 10 CIRCUIT HYBRID RECEPTACLE ASSEMBLY
	DRAFT WHERE APPLICABLE MUST REMAIN WITHIN DIMENSIONS		MATERIAL NO. SEE CHART	DOCUMENT NO. SD-31372-900	SHEET NO. 1 OF 2
	THIS DRAWING CONTAINS INFORMATION THAT IS PROPRIETARY TO MOLEX INCORPORATED AND SHOULD NOT BE USED WITHOUT WRITTEN PERMISSION				
	MOLEX INCORPORATED				

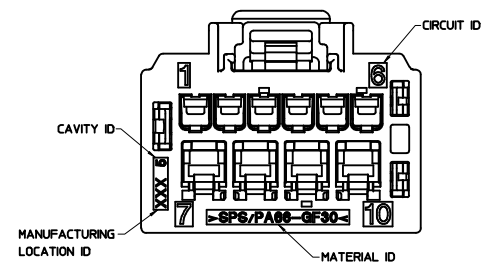
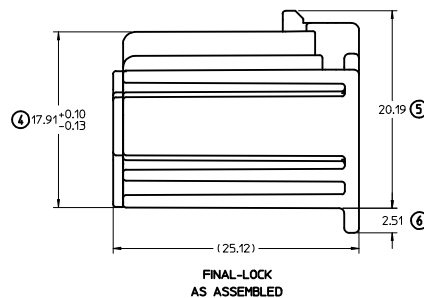
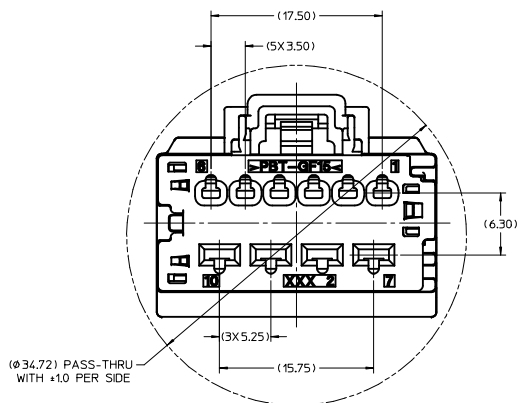
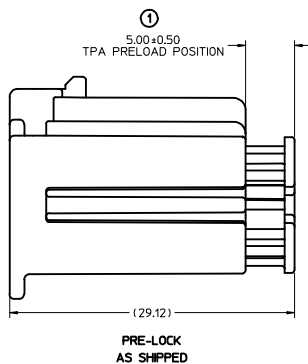
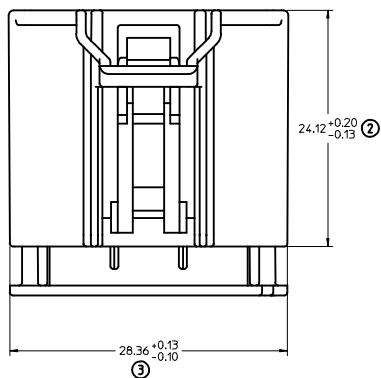

CAPACITY TOOLING IEC NO. UAU2009-1196 DRAWN/DANIELE 2009/06/04 CHECK/BOICK 2009/06/04 APPR./SMARCEAU 2009/06/04	QUALITY SYMBOLS	GENERAL TOLERANCES (UNLESS SPECIFIED)		DIMENSION STYLE	SCALE	DESIGN UNITS	THIRD ANGLE PROJECTION
	▽=0 ▽=0	mm	INCH	MM ONLY	4:1	METRIC	☉ THIRD ANGLE □ PROJECTION
		4 PLACES ± ---	± ---				
		3 PLACES ± ---	± ---				
		2 PLACES ± 0.13	± ---				
		1 PLACE ± 0.25	± ---				
		ANGULAR ± 1°					
	DRAFT WHERE APPLICABLE MUST REMAIN WITHIN DIMENSIONS		SEE CHART		MATERIAL NO. DOCUMENT NO.		SHEET NO.
					SD-31372-900		2 OF 2