

Power Metal Film Leaded Resistors



FEATURES

- High power in small packages (1 W / 0207 size to 3 W / 0617 size)
- Defined fusing characteristics
- Technology: metal film
- Meets active and passive flammability requirements as defined in IEC 60115-1
- AEC-Q200 qualified (PR01 and PR02)
- Material categorization: for definitions of compliance please see www.vishay.com/doc?99912



RoHS
COMPLIANT
HALOGEN
FREE

DESIGN SUPPORT TOOLS

[click logo to get started](#)

3D
Models
Available

DESCRIPTION

A homogeneous film of metal alloy is deposited on a high grade ceramic body. After a helical groove has been cut in the resistive layer, tinned connecting wires of electrolytic copper or copper-clad iron are welded to the end-caps. The resistors are coated with a red, non-flammable lacquer which provides electrical, mechanical and climatic protection. This coating is not resistant to aggressive fluxes and cleaning solvents. The encapsulation is resistant to all cleaning solvents in accordance with IEC 60068-2-45.

APPLICATIONS

- All general purpose power applications
- Automotive electronics
- Lighting ballast

| TECHNICAL SPECIFICATIONS | | | | | |
|--------------------------------------|---------------------------------------|-----------------|-------------------|-----------------|-------------------|
| DESCRIPTION | PR01 | PR02 Cu-lead | PR02 FeCu-lead | PR03 Cu-lead | PR03 FeCu-lead |
| DIN size | 0207 | 0411 | 0411 | 0617 | 0617 |
| Resistance range ⁽¹⁾ | 0.22 Ω to 1 MΩ | 0.33 Ω to 1 MΩ | 1 Ω to 1 MΩ | 0.68 Ω to 1 MΩ | 1 Ω to 1 MΩ |
| Resistance tolerance ⁽²⁾ | ± 1 %; ± 5 % | ± 1 %; ± 5 % | ± 1 %; ± 5 % | ± 1 %; ± 5 % | ± 1 %; ± 5 % |
| Temperature coefficient | ± 250 ppm/K | ± 250 ppm/K | ± 250 ppm/K | ± 250 ppm/K | ± 250 ppm/K |
| Rated dissipation, P_{70} | | | | | |
| $1 \Omega \leq R$ | 1 W | 2 W | 1.3 W | 3 W | 2.5 W |
| $R < 1 \Omega$ | 0.6 W | 1.2 W | - | 1.6 W | - |
| Thermal resistance (R_{th}) | 135 K/W | 75 K/W | 115 K/W | 60 K/W | 75 K/W |
| Operating voltage, U_{max} . AC/DC | 350 V | 500 V | 500 V | 750 V | 750 V |
| E-series | E24, E96 (± 1 %); E24 (± 5 %) | | | | |
| Basic specification | IEC 60115-1 | | | | |
| Stability after: | | | | | |
| Endurance test (1000 h, P_{70}) | ΔR max.: ± (5 % R + 0.1 Ω) | | | | |
| Damp heat test (56 days) | ΔR max.: ± (3 % R + 0.1 Ω) | | | | |
| Soldering (10 s, 260 °C) | ΔR max.: ± (1 % R + 0.05 Ω) | | | | |

Notes

⁽¹⁾ R value is measured with probe distance of 24 mm ± 1 mm using 4-terminal method

⁽²⁾ 1 % tolerance is available for R_n -range from 1 Ω upwards



| TERMINATION WIRE TYPES | | | | | |
|------------------------|----------------|--------|----------|---------------|---------|
| PRODUCT TYPE | PACKAGING CODE | STYLE | MATERIAL | WIRE DIAMETER | PITCH |
| PR01 | A1, A5, R5 | Axial | Cu | 0.58 mm | n/a |
| | N4 | Radial | Cu | 0.58 mm | 4.8 mm |
| | L1 | Radial | Cu | 0.58 mm | 17.8 mm |
| | L1 | Radial | FeCu | 0.58 mm | 17.8 mm |
| | K1 | Radial | FeCu | 0.58 mm | 12.5 mm |
| PR02 | A1, R5 | Axial | Cu | 0.78 mm | n/a |
| | A1 | Axial | FeCu | 0.58 mm | n/a |
| | N3, R2 | Radial | Cu | 0.78 mm | 4.8 mm |
| | L1 | Radial | Cu | 0.78 mm | 17.8 mm |
| | L1 | Radial | FeCu | 0.58 mm | 17.8 mm |
| | B1 | Radial | FeCu | 0.78 mm | 15 mm |
| PR03 | AC | Axial | Cu | 0.78 mm | n/a |
| | AC | Axial | FeCu | 0.58 mm | n/a |
| | DC | Radial | Cu | 0.78 mm | 25.4 mm |
| | DC | Radial | FeCu | 0.58 mm | 25.4 mm |
| | PC | Radial | FeCu | 0.78 mm | 20 mm |

APPLICATION INFORMATION

The power dissipation on the resistor generates a temperature rise against the local ambient, depending on the heat flow support of the printed-circuit board (thermal resistance). The rated dissipation applies only if the permitted film temperature is not exceeded. Furthermore, a high level of ambient temperature or of power dissipation may raise the temperature of the solder joint, hence special solder alloys or board materials may be required to maintain the reliability of the assembly.

These resistors do not feature a limited lifetime when operated within the permissible limits. However, resistance value drift increasing over operating time may result in exceeding a limit acceptable to the specific application, thereby establishing a functional lifetime. The designer may estimate the performance of the particular resistor application or set certain load and temperature limits in order to maintain a desired stability.

| OPERATION MODE | | POWER |
|---|--------|-------------------------------|
| | | P_{70} |
| Rated dissipation | PR01 | 1 W |
| | PR02 | 2 W |
| | PR03 | 3 W |
| Applied maximum film temperature, $\vartheta_{F \max.}$ | | 250 °C |
| Max. resistance change at rated dissipation for resistance range: | PR01 | 0.22 Ω to 1 M Ω |
| | PR02 | 0.33 Ω to 1 M Ω |
| | PR03 | 0.68 Ω to 1 M Ω |
| $ \Delta R/R _{\max.}$ (at P_{70}) after: | 1000 h | 5.0 % R + 0.1 Ω |



| PART NUMBER AND PRODUCT DESCRIPTION | | | | | | | | | | | | | | | | | |
|--------------------------------------|---|--|---|---|--|---|--|------------------------------|---|------------------------|---|--|---|---------------|---|---|---|
| Part Number: PR02000201001JA100 | | | | | | | | | | | | | | | | | |
| P | R | 0 | 2 | 0 | 0 | 0 | 2 | 0 | 1 | 0 | 0 | 1 | J | A | 1 | 0 | 0 |
| TYPE/SIZE | VARIANT | WIRE TYPES | | | TCR/MATERIAL | | RESISTANCE | | | TOLERANCE | | PACKAGING | | SPECIAL | | | |
| PR0100 PR0200 PR0300 | 0 = neutral Z = value overflow (special) | 1 = Cu 0.58 (PR01) 2 = Cu 0.78 (PR02, PR03) 3 = FeCu 0.58 (PR01, PR02, PR03) 4 = FeCu 0.78 (PR02, PR03) | | | 0 = standard | | 3 digit value 1 digit multiplier Multiplier 7 = *10 ⁻³ 8 = *10 ⁻² 9 = *10 ⁻¹ 0 = *10 ⁰ 1 = *10 ¹ 2 = *10 ² 3 = *10 ³ 4 = *10 ⁴ | | | F = ± 1 % J = ± 5 % | | N4 R2 N3 L1 A5 DC A1 K1 AC B1 R5 PC | | 00 = standard | | | |
| Product Description: PR02 5 % A1 1K0 | | | | | | | | | | | | | | | | | |
| PR02 | | 5 % | | | A1 | | | 1K0 | | | | | | | | | |
| TYPE | | TOLERANCE | | | PACKAGING | | | RESISTANCE VALUE | | | | | | | | | |
| PR01 PR02 PR03 | | 1 % 5 % | | | N4 R2 N3 L1 A5 DC A1 K1 AC B1 R5 PC | | | 1K0 = 1 kΩ 4K75 = 4.75 kΩ | | | | | | | | | |

Note

- The products can be ordered using either the PRODUCT DESCRIPTION or the PART NUMBER

| PACKAGING | | | | | | |
|--------------|------|----------|-------------------------------|-------|------------|--------------------------|
| PRODUCT TYPE | CODE | QUANTITY | DESCRIPTION | PITCH | TAPE WIDTH | DIMENSION |
| PR01 | A5 | 5000 | Ammo pack acc. to IEC 60286-1 | 5 mm | 52 mm | 75 mm x 114 mm x 260 mm |
| | A1 | 1000 | Ammo pack acc. to IEC 60286-1 | 5 mm | 52 mm | 78 mm x 31 mm x 260 mm |
| | N4 | 4000 | Ammo pack acc. to IEC 60286-2 | - | - | 45 mm x 262 mm x 330 mm |
| | L1 | 1000 | Loose in bulk | - | - | 105 mm x 70 mm x 205 mm |
| | K1 | 1000 | Loose in bulk | - | - | 105 mm x 70 mm x 205 mm |
| | R5 | 5000 | Reel pack acc. to IEC 60286-1 | 5 mm | 52 mm | 93 mm x 300 mm x 298 mm |
| PR02 | A1 | 1000 | Ammo pack acc. to IEC 60286-1 | 5 mm | 52 mm | 72 mm x 60 mm x 258 mm |
| | N3 | 3000 | Ammo pack acc. to IEC 60286-2 | - | - | 45 mm x 262 mm x 330 mm |
| | L1 | 1000 | Loose in bulk | - | - | 105 mm x 70 mm x 205 mm |
| | B1 | 1000 | Loose in bulk | - | - | 105 mm x 70 mm x 205 mm |
| | R5 | 5000 | Reel pack acc. to IEC 60286-1 | 5 mm | 52 mm | 100 mm x 375 mm x 375 mm |
| | R2 | 2000 | Reel pack acc. to IEC 60286-2 | - | - | 90 mm x 375 mm x 375 mm |
| PR03 | AC | 500 | Ammo pack acc. to IEC 60286-1 | 10 mm | 63 mm | 83 mm x 58 mm x 256 mm |
| | DC | 500 | Loose in bulk | - | - | 105 mm x 70 mm x 205 mm |
| | PC | 500 | Loose in bulk | - | - | 105 mm x 70 mm x 205 mm |



DESCRIPTION

Production is strictly controlled and follows an extensive set of instructions established for reproducibility. A homogeneous film of metal alloy is deposited on a high grade ceramic body and conditioned to achieve the desired temperature coefficient. Plated steel termination caps are firmly pressed on the metalized rods. Mostly, a special laser is used to achieve the target value by smoothly cutting a helical groove in the resistive layer without damaging the ceramics. Connecting wires of electrolytic copper plated with 100 % pure tin are welded to the termination caps. The resistor elements are covered by a red, non-flammable lacquer protective coating designed for electrical, mechanical, and climatic protection. Four or five color code rings designate the resistance value and tolerance in accordance with **IEC 60062**.

The result of the determined production is verified by an extensive testing procedure performed on 100 % of the individual resistors. Only accepted products are stuck directly on the adhesive tapes in accordance with **IEC 60286-1** or for the radial versions in accordance to **IEC 60286-2**.

MATERIALS

Vishay acknowledges the following systems for the regulation of hazardous substances:

- IEC 62474, Material Declaration for Products of and for the Electrotechnical Industry, with the list of declarable substances given therein ⁽¹⁾
- The Global Automotive Declarable Substance List (GADSL) ⁽²⁾
- The REACH regulation (1907/2006/EC) and the related list of substances with very high concern (SVHC) ⁽³⁾ for its supply chain

The products do not contain any of the banned substances as per IEC 62474, GADSL, or the SVHC list, see www.vishay.com/how/leadfree.

Hence the products fully comply with the following directives:

- 2000/53/EC End-of-Life Vehicle Directive (ELV) and Annex II (ELV II)
- 2011/65/EU Restriction of the Use of Hazardous Substances Directive (RoHS) with amendment 2015/863/EU
- 2012/19/EU Waste Electrical and Electronic Equipment Directive (WEEE)

Vishay pursues the elimination of conflict minerals from its supply chain, see the Conflict Minerals Policy at www.vishay.com/doc?49037.

Notes

- (1) The IEC 62474 list of declarable substances is maintained in a dedicated database, which is available at <http://std.iec.ch/iec62474>
- (2) The Global Automotive Declarable Substance List (GADSL) is maintained by the American Chemistry Council, and available at www.gadsl.org
- (3) The SVHC list is maintained by the European Chemical Agency (ECHA) and available at <http://echa.europa.eu/candidate-list-table>

ASSEMBLY

The resistors are suitable for processing on automatic insertion equipment and cutting and bending machines. Excellent solderability is proven, even after extended storage. They are suitable for automatic soldering using wave or dipping.

The resistors are completely lead (Pb)-free, the pure tin plating provides compatibility with lead (Pb)-free and lead-containing soldering processes. The immunity of the plating against tin whisker growth, in compliance with IEC 60068-2-82, has been proven under extensive testing.

The encapsulant is resistant to cleaning solvent specified in IEC 60115-1. The suitability of conformal coatings, if applied, shall be qualified by appropriate means to ensure the long-term stability of the whole system.

RELATED PRODUCTS

For a correlated range of Metal Film Resistors see the datasheet:

“High Ohmic / High Voltage Metal Film Leaded Resistors”, www.vishay.com/doc?30260

For product that offers high power dissipation and metal oxide film technology see the datasheet:

“High Power Metal Oxide Leaded Resistors”, www.vishay.com/doc?20128

FUNCTIONAL PERFORMANCE

The power that the resistor can dissipate depends on the operating temperature.

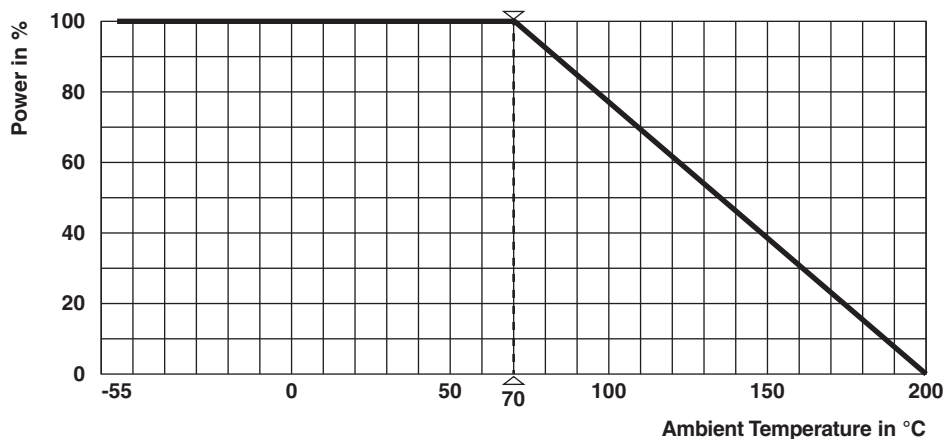

Derating

Maximum dissipation ($P_{max.}$) in percentage of rated power as a function of the ambient temperature (T_{amb})

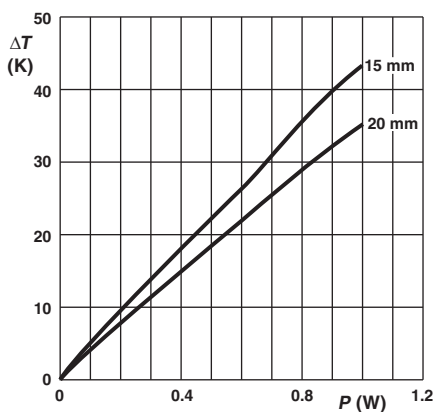

Ø 0.58 mm Cu-leads

Minimum distance from resistor body to PCB = 1 mm

PR01 Temperature rise (ΔT) at the lead end (soldering point) as a function of dissipated power at various lead lengths after mounting.

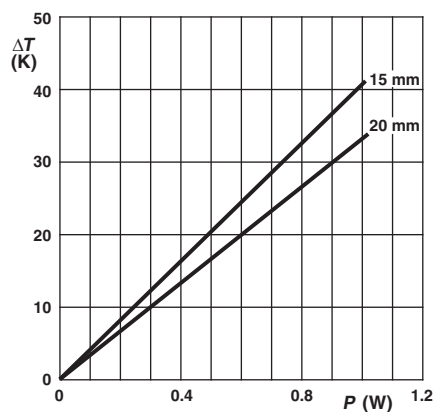

Ø 0.58 mm FeCu-leads

Minimum distance from resistor body to PCB = 1 mm

PR01 Temperature rise (ΔT) at the lead end (soldering point) as a function of dissipated power at various lead lengths after mounting.

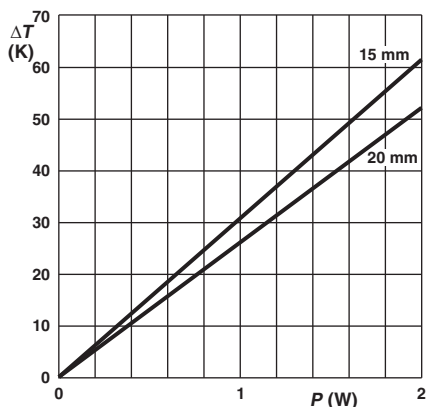

Ø 0.58 mm FeCu-leads

Minimum distance from resistor body to PCB = 1 mm

PR02 Temperature rise (ΔT) at the lead end (soldering point) as a function of dissipated power at various lead lengths after mounting.

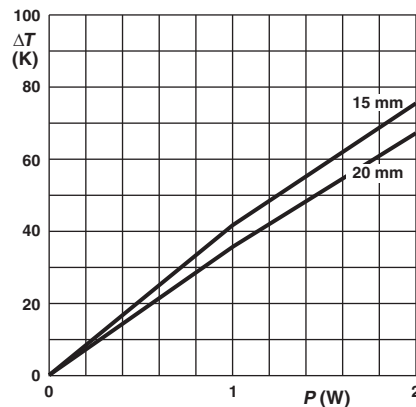

Ø 0.78 mm Cu-leads

Minimum distance from resistor body to PCB = 1 mm

PR02 Temperature rise (ΔT) at the lead end (soldering point) as a function of dissipated power at various lead lengths after mounting.



Ø 0.78 mm FeCu-leads
Minimum distance from resistor body to PCB = 1 mm

PR02 Temperature rise (ΔT) at the lead end (soldering point) as a function of dissipated power at various lead lengths after mounting.



Ø 0.78 mm Cu-leads
Minimum distance from resistor body to PCB = 1 mm

PR03 Temperature rise (ΔT) at the lead end (soldering point) as a function of dissipated power at various lead lengths after mounting.



Ø 0.58 mm FeCu-leads
Minimum distance from resistor body to PCB = 1 mm

PR03 Temperature rise (ΔT) at the lead end (soldering point) as a function of dissipated power at various lead lengths after mounting.



Ø 0.78 mm FeCu-leads
Minimum distance from resistor body to PCB = 1 mm

PR03 Temperature rise (ΔT) at the lead end (soldering point) as a function of dissipated power at various lead lengths after mounting.



Ø 0.58 mm Cu-leads

PR01 Hot-spot temperature rise (ΔT) as a function of dissipated power.

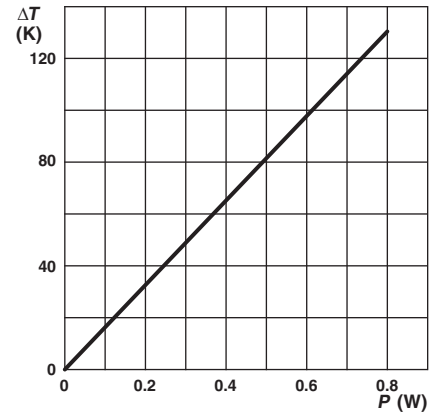

Ø 0.58 mm FeCu-leads

PR01 Hot-spot temperature rise (ΔT) as a function of dissipated power.



Ø 0.78 mm Cu-leads

PR02 Hot-spot temperature rise (ΔT) as a function of dissipated power.

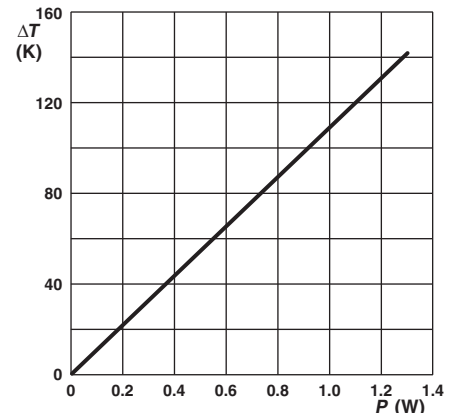

Ø 0.78 mm FeCu-leads

PR02 Hot-spot temperature rise (ΔT) as a function of dissipated power.



Ø 0.58 mm FeCu-leads

PR02 Hot-spot temperature rise (ΔT) as a function of dissipated power.

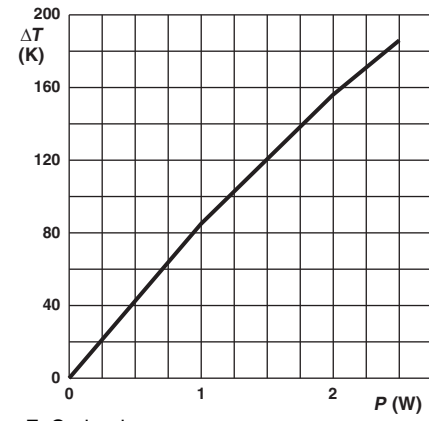

Ø 0.58 mm FeCu-leads

PR03 Hot-spot temperature rise (ΔT) as a function of dissipated power.



Ø 0.78 mm Cu-leads

PR03 Hot-spot temperature rise (ΔT) as a function of dissipated power.

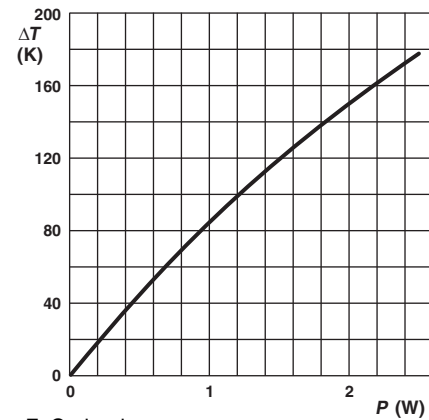

Ø 0.78 mm FeCu-leads

PR03 Hot-spot temperature rise (ΔT) as a function of dissipated power.



The maximum permissible hot-spot temperature is 205 °C for PR01, 220 °C for PR02 and 250 °C for PR03.



PR01 Drift nomogram



PR02 Drift nomogram



PR03 Drift nomogram



PR01 Pulse on a regular basis; maximum permissible peak pulse power (\hat{P}_{max}) as a function of pulse duration (t_i)



PR01 Pulse on a regular basis; maximum permissible peak pulse voltage (\hat{U}_{max}) as a function of pulse duration (t_i)



PR02 Pulse on a regular basis; maximum permissible peak pulse power (\hat{P}_{max}) as a function of pulse duration (t_i)



PR02 Pulse on a regular basis; maximum permissible peak pulse voltage (\hat{U}_{max}) as a function of pulse duration (t_i)

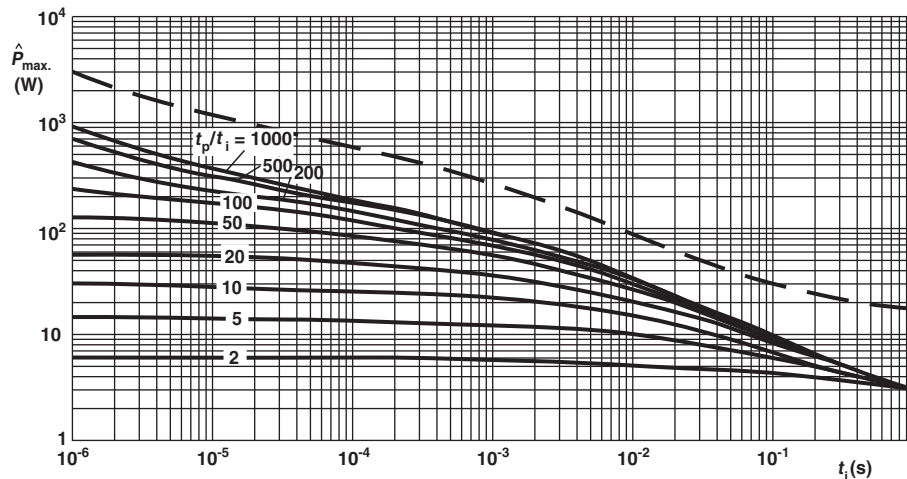

PR03 Pulse on a regular basis; maximum permissible peak pulse power (\hat{P}_{max}) as a function of pulse duration (t_i)



PR03 Pulse on a regular basis; maximum permissible peak pulse voltage (\hat{U}_{max}) as a function of pulse duration (t_i)



PR01 Time to interruption as a function of overload power for range: $0.22 \Omega \leq R_n < 1 \Omega$
 This graph is based on measured data under constant voltage conditions; the data may deviate according to the applications.



PR01 Time to interruption as a function of overload power for range: $16 \Omega \leq R_n \leq 560 \Omega$
 This graph is based on measured data under constant voltage conditions; the data may deviate according to the applications.



PR01 Time to interruption as a function of overload power for range: $1 \Omega \leq R_n \leq 15 \Omega$
 This graph is based on measured data under constant voltage conditions; the data may deviate according to the applications.



PR02 Time to interruption as a function of overload power for range: $0.33 \Omega \leq R_n \leq 5 \Omega$
 This graph is based on measured data under constant voltage conditions; the data may deviate according to the applications.



PR02 Time to interruption as a function of overload power for range: $5 \Omega \leq R_n \leq 68 \Omega$
 This graph is based on measured data under constant voltage conditions; the data may deviate according to the applications.



PR02 Time to interruption as a function of overload power for range: $68 \Omega \leq R_n \leq 560 \Omega$
 This graph is based on measured data under constant voltage conditions; the data may deviate according to the applications.



PR03 Time to interruption as a function of overload power for range: $0.68 \Omega \leq R_n \leq 560 \Omega$

This graph is based on measured data under constant voltage conditions; the data may deviate according to the applications.



PR01 Impedance as a function of applied frequency



PR02 Impedance as a function of applied frequency



PR03 Impedance as a function of applied frequency



TESTS PROCEDURES AND REQUIREMENTS

All tests are carried out in accordance with the following specifications:

- IEC 60115-1, generic specification (includes tests)

The test and requirements table contains only the most important tests. For the full test schedule refer to the documents listed above.

The tests are carried out in accordance with IEC 60068-2-xx test method and under standard atmospheric conditions in accordance with IEC 60068-1, 5.3.

Climatic category LCT / UCT / 56 (rated temperature range: lower category temperature, upper category temperature; damp heat, steady state, test duration: 56 days) is valid.

Unless otherwise specified the following values apply:

- Temperature: 15 °C to 35 °C
- Relative humidity: 45 % to 75 %
- Air pressure: 86 kPa to 106 kPa (860 mbar to 1060 mbar).

For performing some of the tests, the components are mounted on a test board in accordance with IEC 60115-1, 4.31.

In test procedures and requirements table, only the tests and requirements are listed with reference to the relevant clauses of IEC 60115-1 and IEC 60068-2-xx test methods. A short description of the test procedure is also given.

| TEST PROCEDURES AND REQUIREMENTS | | | | |
|----------------------------------|-------------------------------|------------------------------|---|--|
| IEC 60115-1 CLAUSE | IEC 60068-2-TEST METHOD | TEST | PROCEDURE | REQUIREMENTS PERMISSIBLE CHANGE ($\Delta R_{max.}$) |
| 4.4.1 | - | Visual examination | | No holes; clean surface; no damage |
| 4.4.2 | - | Dimensions (outline) | Gauge (mm) | See Straight and Kinked Dimensions tables |
| 4.5 | - | Resistance | | $\pm 5 \% R$ |
| 4.6.1.1 | - | Insulation resistance | Maximum voltage (DC) after 1 min; metal block method | $R_{ins \text{ min.}}: 10^4 \text{ M}\Omega$ |
| 4.7 | - | Voltage proof | $U_{RMS} = U_{ins}; 60 \text{ s}$ | No breakdown or flashover |
| 4.8 | - | Temperature coefficient | At (20 / -55 / 20) °C and (20 / 155 / 20) °C | $\leq \pm 250 \text{ ppm/K}$ |
| 4.16 | 21 (Ja) 21 (Ub) 21 (Uc) | Robustness of terminations | Tensile, bending, and torsion | No damage $\Delta R_{max.}: \pm (0.5 \% R + 0.05 \Omega)$ |
| 4.17 | 20 (Ta) | Solderability | +235 °C; 2 s; solder bath method; SnPb40 | Good tinning ($\geq 95 \%$ covered, no visible damage) |
| | | | +245 °C; 3 s; solder bath method; SnAg3Cu0.5 | Good tinning ($\geq 95 \%$ covered, no visible damage) |
| 4.18.2 | 20 (Tb) | Resistance to soldering heat | Unmounted components (260 \pm 5) °C; (10 \pm 1) s | $\Delta R_{max.}: \pm (1 \% R + 0.05 \Omega)$ |
| 4.19 | 14 (Na) | Rapid change of temperature | 30 min at -55 °C and 30 min at +200 °C; 5 cycles | No visual damage PR01: $\Delta R_{max.}: \pm (1 \% R + 0.05 \Omega)$ PR02: $\Delta R_{max.}: \pm (1 \% R + 0.05 \Omega)$ PR03: $\Delta R_{max.}: \pm (2 \% R + 0.05 \Omega)$ |
| 4.20 | 29 (Eb) | Bump | 3 x 1500 bumps in three directions; 40 g | No damage $\Delta R_{max.}: \pm (0.5 \% R + 0.05 \Omega)$ |
| 4.22 | 6 (Fc) | Vibration | 10 sweep cycles per direction; 10 Hz to 2000 Hz; 1.5 mm or 200 m/s ² | No damage $\Delta R_{max.}: \pm (0.5 \% R + 0.05 \Omega)$ |

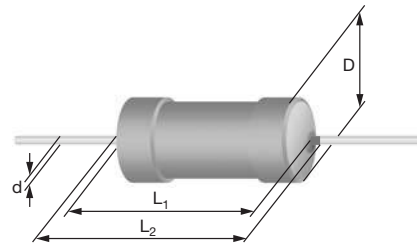

| TEST PROCEDURES AND REQUIREMENTS | | | | |
|----------------------------------|-------------------------|------------------------------|--|--|
| IEC 60115-1 CLAUSE | IEC 60068-2-TEST METHOD | TEST | PROCEDURE | REQUIREMENTS PERMISSIBLE CHANGE ($\Delta R_{max.}$) |
| 4.23 | | Climatic sequence: | | |
| 4.23.2 | 2 (Ba) | Dry heat | 200 °C; 16 h | $R_{ins \text{ min.}}: 10^3 \text{ M}\Omega$ $\Delta R_{max.}: \pm (1.5 \% R + 0.1 \Omega)$ |
| 4.23.3 | 30 (Db) | Damp heat, cyclic | 55 °C; 24 h; 90 % to 100 % RH; 1 cycle | |
| 4.23.4 | 1 (Aa) | Cold | -55 °C; 2 h | |
| 4.23.5 | 13 (M) | Low air pressure | 8.5 kPa; 2 h; 15 °C to 35 °C | |
| 4.23.6 | 30 (Db) | Damp heat, cyclic | 55 °C; 5 days; 95 % to 100 % RH; 5 cycles | |
| 4.24 | 78 (Cab) | Damp heat (steady state) | (40 ± 2) °C; 56 days; (93 ± 3) % RH | |
| 4.25.1 | - | Endurance (at 70 °C) | $U = \sqrt{P_{70}} \times \bar{R}$ or $U = U_{max.}$; 1.5 h on; 0.5 h off; 70 °C; 1000 h | $\Delta R_{max.}: \pm (5 \% R + 0.1 \Omega)$ |
| 4.26 | - | Active flammability | Accidental overload test | No damage, no flaming of gauze cylinder |
| 4.29 | 45 (Xa) | Component solvent resistance | Isopropyl alcohol (used in industrial application) +23 °C; toothbrush method | Marking legible; no visible damage |
| 4.35 | - | Passive flammability | Needle flame test | No ignition of product, no ignition of under layer burning time is less than 30 s |

DIMENSIONS

Type with straight leads

| DIMENSIONS - Straight lead type and relevant physical dimensions; see straight leads outline | | | | | | |
|---|--------------------------|--------------------------|--------------------------|--|-------------|-----------|
| TYPE | Ø D _{MAX.} (mm) | L ₁ MAX. (mm) | L ₂ MAX. (mm) | TERMINATION WIRE MATERIAL (Cu OR FeCu) AND WIRE DIAMETER (Ø d) | | MASS (mg) |
| | | | | MATERIAL | Ø d (mm) | |
| PR01 | 2.5 | 6.5 | 8.0 | Cu | 0.58 ± 0.05 | 212 |
| | | | | FeCu | 0.58 ± 0.05 | 207 |
| PR02 | 3.9 | 10.0 | 12.0 | Cu | 0.78 ± 0.05 | 504 |
| | | | | FeCu | 0.58 ± 0.05 | 455 |
| | | | | FeCu | 0.78 ± 0.05 | 496 |
| PR03 | 5.2 | 16.7 | 19.5 | Cu | 0.78 ± 0.05 | 1192 |
| | | | | FeCu | 0.58 ± 0.05 | 1079 |
| | | | | FeCu | 0.78 ± 0.05 | 1185 |

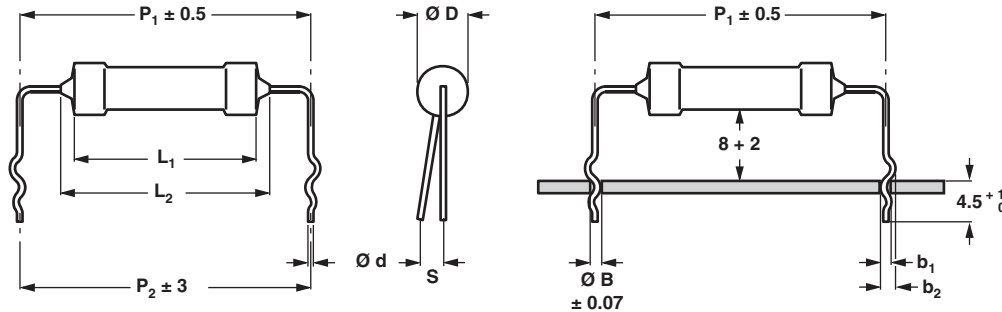

Type with double kink

Dimensions in millimeters

| DIMENSIONS - Double kink lead type and relevant physical dimensions; see double kinked outline | | | | | | | | | | | | | |
|---|--------------------------|--------------------------|--------------------------|--|-------------|-----------|------------|---------------------|---------------------|----------------------|----------------------|------------------------|------------|
| TYPE | Ø D _{MAX.} (mm) | L ₁ MAX. (mm) | L ₂ MAX. (mm) | TERMINATION WIRE MATERIAL (Cu OR FeCu) AND WIRE DIAMETER (Ø d) | | MASS (mg) | PITCH (mm) | P ₁ (mm) | P ₂ (mm) | b ₁ (mm) | b ₂ (mm) | S _{MAX.} (mm) | Ø B (mm) |
| | | | | MATERIAL | Ø d (mm) | | | | | | | | |
| PR01 | 2.5 | 6.5 | 8.0 | Cu | 0.58 ± 0.05 | 212 | 17.8 | 17.8 ± 0.5 | 17.8 ± 3 | 1.10 + 0.25 / - 0.20 | 1.45 + 0.25 / - 0.20 | 2 | 0.8 ± 0.07 |
| | | | | FeCu | 0.58 ± 0.05 | 207 | 12.5 | 12.5 ± 0.5 | 12.5 ± 3 | 1.10 + 0.25 / - 0.20 | 1.45 + 0.25 / - 0.20 | 2 | 0.8 ± 0.07 |
| | | | | FeCu | 0.58 ± 0.05 | 207 | 17.8 | 17.8 ± 0.5 | 17.8 ± 3 | 1.10 + 0.25 / - 0.20 | 1.45 + 0.25 / - 0.20 | 2 | 0.8 ± 0.07 |
| PR02 | 3.9 | 10.0 | 12.0 | Cu | 0.78 ± 0.05 | 504 | 17.8 | 17.8 ± 0.5 | 17.8 ± 3 | 1.10 + 0.25 / - 0.20 | 1.45 + 0.25 / - 0.20 | 2 | 1.0 ± 0.07 |
| | | | | FeCu | 0.58 ± 0.05 | 455 | 17.8 | 17.8 ± 0.5 | 17.8 ± 3 | 1.10 + 0.25 / - 0.20 | 1.45 + 0.25 / - 0.20 | 2 | 0.8 ± 0.07 |
| | | | | FeCu | 0.78 ± 0.05 | 496 | 15.0 | 15.0 ± 0.5 | 15.0 ± 3 | 1.30 + 0.25 / - 0.20 | 1.65 + 0.25 / - 0.20 | 2 | 1.0 ± 0.07 |
| PR03 | 5.2 | 16.7 | 19.5 | Cu | 0.78 ± 0.05 | 1192 | 25.4 | 25.4 ± 0.5 | 25.4 ± 3 | 1.10 + 0.25 / - 0.20 | 1.65 + 0.25 / - 0.20 | 2 | 1.0 ± 0.07 |
| | | | | FeCu | 0.58 ± 0.05 | 1079 | 25.4 | 25.4 ± 0.5 | 25.4 ± 3 | 1.10 + 0.25 / - 0.20 | 1.65 + 0.25 / - 0.20 | 2 | 1.0 ± 0.07 |
| | | | | FeCu | 0.78 ± 0.05 | 1185 | 20 | 22.0 ± 0.5 | 20.0 ± 3 | 1.30 + 0.25 / - 0.20 | 2.15 + 0.25 / - 0.20 | 2 | 1.0 ± 0.07 |

PR01, PR02 WITH RADIAL TAPING
PR01 - Height for insertion (max.) = 32 mm

| DIMENSIONS in millimeters | | |
|---|----------------|-------------|
| Pitch of components | P | 12.7 ± 1.0 |
| Feed-hole pitch | P ₀ | 12.7 ± 0.2 |
| Feed-hole centre to lead at topside at the tape | P ₁ | 3.85 ± 0.5 |
| Feed-hole center to body center | P ₂ | 6.35 ± 1.0 |
| Lead spacing | F | 4.8 +0.7/-0 |
| Width of carrier tape | W | 18.0 ± 0.5 |
| Minimum hold down tape width | W ₀ | 5.5 |
| Height for insertion (max.) | H ₁ | 32 |
| Lead wire clinch height | H ₀ | 16.5 ± 0.5 |
| Body to hole center | H | 19.5 ± 1 |
| Feed-hole diameter | D ₀ | 4.0 ± 0.2 |
| Height for cutting (max.) | L | 11.0 |
| Minimum lead wire (tape portion) shortest lead | L ₁ | 2.5 |

PR02 - Height for insertion (max.) = 29 mm

| DIMENSIONS in millimeters | | |
|---|----------------|-------------|
| Pitch of components | P | 12.7 ± 1.0 |
| Feed-hole pitch | P ₀ | 12.7 ± 0.2 |
| Feed-hole centre to lead at topside at the tape | P ₁ | 3.85 ± 0.5 |
| Feed-hole center to body center | P ₂ | 6.35 ± 1.0 |
| Lead spacing | F | 4.8 +0.7/-0 |
| Width of carrier tape | W | 18.0 ± 0.5 |
| Minimum hold down tape width | W ₀ | 5.5 |
| Height for insertion (max.) | H ₁ | 29 |
| Lead wire clinch height | H ₀ | 16.5 ± 0.5 |
| Body to hole center | H | 19.5 ± 1 |
| Feed-hole diameter | D ₀ | 4.0 ± 0.2 |
| Height for cutting (max.) | L | 11.0 |
| Minimum lead wire (tape portion) shortest lead | L ₁ | 2.5 |

MARKING

The nominal resistance and tolerance are marked on the resistor using four or five colored bands in accordance with IEC 60062, marking codes for resistors and capacitors.



12NC INFORMATION FOR HISTORICAL CODING REFERENCE

The resistors have a 12-digit numeric code starting with 23

For 5 % tolerance:

- The next 7 digits indicate the resistor type and packing
- The remaining 3 digits indicate the resistance value:
 - The first 2 digits indicate the resistance value
 - The last digit indicates the resistance decade

For 1 % tolerance:

- The next 6 digits indicate the resistor type and packing
- The remaining 4 digits indicate the resistance value:
 - The first 3 digits indicate the resistance value
 - The last digit indicates the resistance decade

Last Digit of 12NC Indicating Resistance Decade

| RESISTANCE DECADE | LAST DIGIT |
|-------------------|------------|
| 0.22 Ω to 0.91 Ω | 7 |
| 1 Ω to 9.76 Ω | 8 |
| 10 Ω to 97.6 Ω | 9 |
| 100 Ω to 976 Ω | 1 |
| 1 Ω to 9.76 kΩ | 2 |
| 10 Ω to 97.6 kΩ | 3 |
| 100 Ω to 976 kΩ | 4 |
| 1 MΩ | 5 |

12NC Example

The 12NC for resistor type PR02 with Cu leads and a value of 750 Ω with 5 % tolerance, supplied on a bandolier of 1000 units in ammopack, is: 2306 198 53751.

| 12NC - Resistor Type and Packaging ⁽¹⁾ | | | | | | | | | |
|--|------------|-----------|-------------------------|--------------|---------------------|---------------------|---------------------|---------------------|-----------------------|
| TYPE | LEAD Ø mm | TOL. (%) | 23.. (BANDOLIER) | | | | | | |
| | | | AMMOPACK | | | | REEL | | |
| | | | RADIAL TAPED | | STRAIGHT LEADS | | | RADIAL TAPED | |
| | | | 4000 UNITS | 3000 UNITS | 52 mm | 52 mm | 63 mm | | 52 mm |
| 5000 UNITS | 1000 UNITS | 500 UNITS | 5000 UNITS | 2000 UNITS | | | | | |
| PR01 | Cu 0.58 | 1 | - | - | 22 196 1... | 06 191 2... | - | 06 191 5... | - |
| | | 5 | 06 197 03... | - | 22 193 14... | 06 197 53... | - | 06 197 23... | - |
| PR02 | Cu 0.78 | 1 | - | 22 197 2... | - | 22 197 1... | - | - | 2322 197 5... |
| | | 5 | - | 06 198 03... | - | 06 198 53... | - | - | 2322 198 04... |
| | FeCu 0.58 | 5 | - | - | - | 22 194 54... | - | - | - |
| PR03 | Cu 0.78 | 5 | - | - | - | - | 22 195 14... | - | - |
| | | 1 | - | - | - | - | 06 199 6... | - | - |
| | FeCu 0.58 | 5 | - | - | - | - | 22 195 54... | - | - |

Notes

- Preferred types in bold
- (1) Other packaging versions are available on request

| 12NC - Resistor Type and Packaging | | | | | | | | |
|---|-----------|----------|----------------------------|--------------|------------------------------------|------------------------------------|----------------------------|--|
| TYPE | LEAD Ø mm | TOL. (%) | 23.. (LOOSE IN BOX) | | | | | |
| | | | DOUBLE KINK | | | | | |
| | | | PITCH = 17.8 mm | | PITCH = 25.4 mm | | PITCH ⁽²⁾⁽³⁾⁽⁴⁾ | |
| | | | 1000 UNITS | | 500 UNITS | | 500 UNITS | |
| PR01 | Cu 0.58 | 5 | 22 193 03... | - | - | - | | |
| | FeCu 0.58 | 5 | 22 193 43... | - | 22 193 53... ⁽²⁾ | - | | |
| PR02 | Cu 0.78 | 5 | 22 194 23... | - | - | - | | |
| | FeCu 0.58 | 5 | 22 194 83... | - | - | - | | |
| | FeCu 0.78 | 5 | - | - | 22 194 63... ⁽³⁾ | - | | |
| PR03 | Cu 0.78 | 5 | - | 22 195 23... | - | - | | |
| | FeCu 0.58 | 5 | - | 22 195 83... | - | - | | |
| | FeCu 0.78 | 5 | - | - | - | 22 195 63... ⁽⁴⁾ | | |

Notes

- Preferred types in bold
- (2) PR01 pitch 12.5 mm
- (3) PR02 pitch 15.0 mm
- (4) PR03 pitch 20.0 mm, with reversed kinking direction as opposed to the drawing for the type with double kink figure



Disclaimer

ALL PRODUCT, PRODUCT SPECIFICATIONS AND DATA ARE SUBJECT TO CHANGE WITHOUT NOTICE TO IMPROVE RELIABILITY, FUNCTION OR DESIGN OR OTHERWISE.

Vishay Intertechnology, Inc., its affiliates, agents, and employees, and all persons acting on its or their behalf (collectively, "Vishay"), disclaim any and all liability for any errors, inaccuracies or incompleteness contained in any datasheet or in any other disclosure relating to any product.

Vishay makes no warranty, representation or guarantee regarding the suitability of the products for any particular purpose or the continuing production of any product. To the maximum extent permitted by applicable law, Vishay disclaims (i) any and all liability arising out of the application or use of any product, (ii) any and all liability, including without limitation special, consequential or incidental damages, and (iii) any and all implied warranties, including warranties of fitness for particular purpose, non-infringement and merchantability.

Statements regarding the suitability of products for certain types of applications are based on Vishay's knowledge of typical requirements that are often placed on Vishay products in generic applications. Such statements are not binding statements about the suitability of products for a particular application. It is the customer's responsibility to validate that a particular product with the properties described in the product specification is suitable for use in a particular application. Parameters provided in datasheets and / or specifications may vary in different applications and performance may vary over time. All operating parameters, including typical parameters, must be validated for each customer application by the customer's technical experts. Product specifications do not expand or otherwise modify Vishay's terms and conditions of purchase, including but not limited to the warranty expressed therein.

Hyperlinks included in this datasheet may direct users to third-party websites. These links are provided as a convenience and for informational purposes only. Inclusion of these hyperlinks does not constitute an endorsement or an approval by Vishay of any of the products, services or opinions of the corporation, organization or individual associated with the third-party website. Vishay disclaims any and all liability and bears no responsibility for the accuracy, legality or content of the third-party website or for that of subsequent links.

Except as expressly indicated in writing, Vishay products are not designed for use in medical, life-saving, or life-sustaining applications or for any other application in which the failure of the Vishay product could result in personal injury or death. Customers using or selling Vishay products not expressly indicated for use in such applications do so at their own risk. Please contact authorized Vishay personnel to obtain written terms and conditions regarding products designed for such applications.

No license, express or implied, by estoppel or otherwise, to any intellectual property rights is granted by this document or by any conduct of Vishay. Product names and markings noted herein may be trademarks of their respective owners.