



*DC COMPONENTS CO., LTD.*

RECTIFIER SPECIALISTS

SS52F  
THRU  
SS520F

**TECHNICAL SPECIFICATIONS OF SCHOTTKY BARRIER RECTIFIER**

**VOLTAGE RANGE - 20 to 200 Volts**

**CURRENT - 5.0 Amperes**

**FEATURES**

- \* Ideal for surface mounted applications
- \* Glass passivated junction
- \* Low leakage current
- \* Low power loss
- \* High efficiency

**MECHANICAL DATA**

- \* Case: Molded plastic
- \* Epoxy: UL 94V-0 rate flame retardant
- \* Terminals: Solder plated solderable per MIL-STD-750, Method 2026
- \* Polarity: As marked
- \* Mounting position: Any
- \* Weight: 0.03 gram

**MAXIMUM RATINGS AND ELECTRICAL CHARACTERISTICS**

Ratings at 25 °C ambient temperature unless otherwise specified.  
Single phase, half wave, 60 Hz, resistive or inductive load.  
For capacitive load, derate current by 20%.



SMAFL

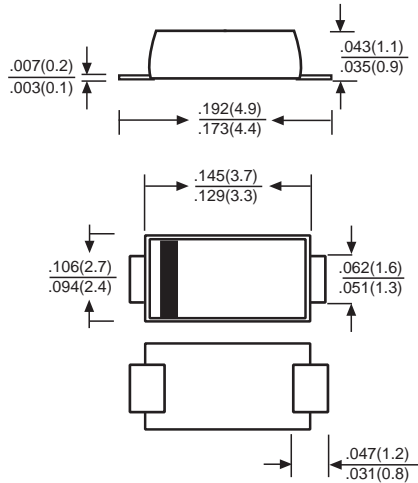

	SYMBOL	SS52F	SS54F	SS56F	SS58F	SS510F	SS512F	SS515F	SS520F	UNITS	
Maximum Recurrent Peak Reverse Voltage	VRRM	20	40	60	80	100	120	150	200	Volts	
Maximum RMS Voltage	VRMS	14	28	42	56	70	84	105	140	Volts	
Maximum DC Blocking Voltage	Vbc	20	40	60	80	100	120	150	200	Volts	
Maximum Average Forward Rectified Current at Derating Lead Temperature at TA = 75 °C	IO	5.0								Amps	
Peak Forward Surge Current 8.3 ms single half sine-wave superimposed on rated load (JEDEC Method)	IFSM	150								Amps	
Maximum Instantaneous Forward Voltage at 5.0A DC	VF	0.45	0.55	0.70		0.85				Volts	
Maximum DC Reverse Current at Rated DC Blocking Voltage	IR	@ TA = 25°C	1.0								mAmps
		@ TA = 100°C	50								
Typical Thermal Resistance (Note 1)	RθJA	45								°C/W	
Typical Junction Capacitance (Note 2)	CJ	800			500					pF	
Operating Temperature Range	TJ	-55 to +125								°C	
Storage Temperature Range	TSTG	-55 to +150								°C	

- NOTES : 1. Thermal Resistance (Junction to Ambient)  
2. Measured at 1 MHz and applied reverse voltage of 4.0 volts.  
3. P.C.B. mounted with 0.5x0.5"(12.7x12.7mm<sup>2</sup>) copper pad area.

# RATING AND CHARACTERISTIC CURVES ( SS52F THRU SS520F )

FIG.1 - TYPICAL FORWARD CURRENT DERATING CURVE

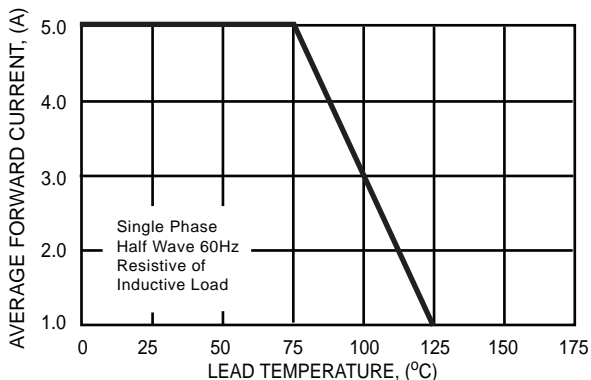

FIG.2 - TYPICAL INSTANTANEOUS FORWARD CHARACTERISTICS

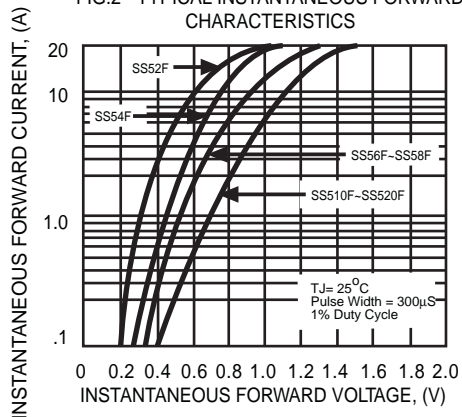

FIG.3 - TYPICAL REVERSE CHARACTERISTICS

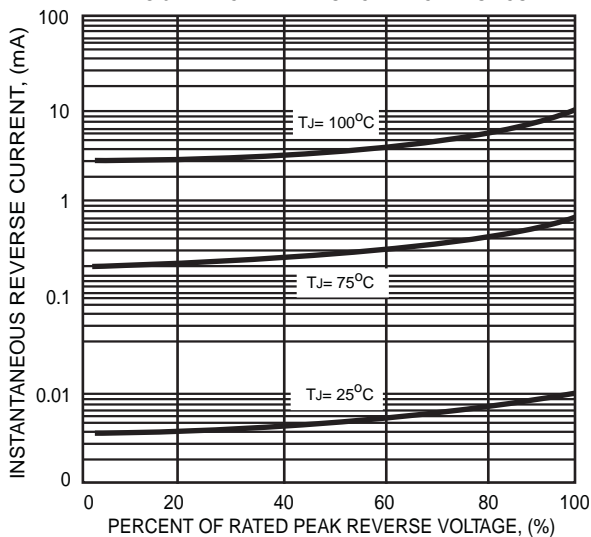

FIG.4 - TYPICAL TRANSIENT THERMAL IMPEDANCE

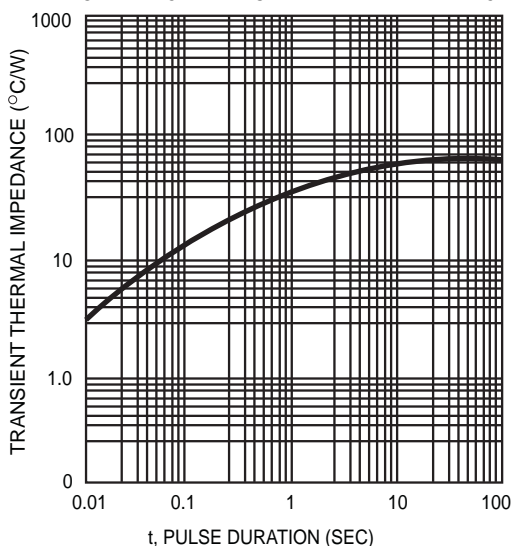

FIG.5 - TYPICAL JUNCTION CAPACITANCE

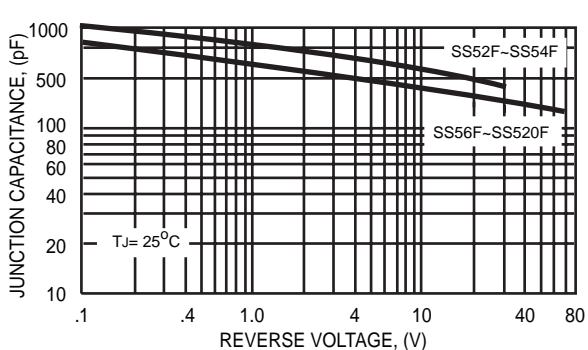
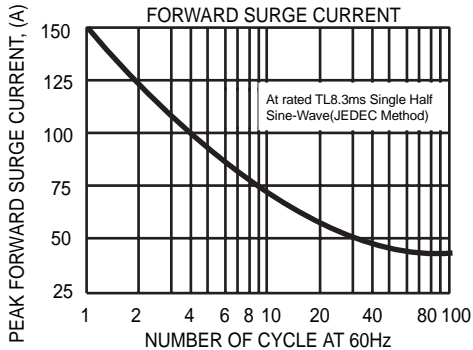

FIG.6 - MAXIMUM NON-REPETITIVE FORWARD SURGE CURRENT



## Disclaimer

Any Customer or user of this document or products described herein in such applications shall assume all risks of such use and will agree to hold *DC COMPONENTS* harmless against all damages.

*DC COMPONENTS* disclaims any and all liability arising out of the application or use of any product, including consequential or incidental damages. It is the customer's responsibility to validate that a particular product with the properties described in the product specification is suitable for use in a particular application.

*DC COMPONENTS* reserve the right to make modifications, enhancements, improvements, corrections or other changes without further notice to this document and any product described herein, and disclaim any and all liability for any errors, inaccuracies or incompleteness contained in any datasheet or in any other disclosure relating to any product.

Unless otherwise in writing, *DC COMPONENTS* products are intended for use as general electronic components in standard applications ( eg: Consumer electronic, Computer equipment, Office equipment, etc.), and not recommended for use in a high specific application where a failure or malfunction of the device could result in human injury or death ( eg: Aerospace equipment, Submarine cables, Combustion equipment, Safety devices, Life support systems, etc.)

Customers using or selling *DC COMPONENTS* products not expressly indicated for use in such applications do so at their own risk. If customer intended to use *DC COMPONENTS* standard quality grade devices for applications not envisioned by *DC COMPONENTS*, please contact our sales representatives in advance.



*DC COMPONENTS CO., LTD.*