



COAXIAL, BUILT-IN RF SWITCH

High Power Amplifier

ZHL-20W-13SW+ ZHL-20W-13SWX+

50Ω 20W 20 to 1000 MHz

FEATURES

- High power, 20 Watt
- Protected against overheat - shuts off automatically at about +100°C case temperature
- Protected against over voltage - shuts off automatically at about +29V(excluding fan)
- Excellent gain flatness, ±1.2 dB typ.
- RF built-in switch with TTL/CMOS control
- Class A amplifier
- Protected by US patent 7,348,854

APPLICATIONS

- VHF/UHF transmitters
- Defense
- Amateur radio, FM, TV



Generic photo used for illustration purposes only

Model No.	ZHL-20W-13SW+	ZHL-20W-13SWX+▲
Option	With heatsink & fan	Without heatsink & fan
Case Style	CP1683	
Connectors	SMA	

+RoHS Compliant
The +Suffix identifies RoHS Compliance.
See our website for methodologies and qualifications

ELECTRICAL SPECIFICATIONS AT 25°C

Parameter	Condition (MHz)	ZHL-20W-13SW+ ZHL-20W-13SWX+▲			Units
		Min.	Typ.	Max.	
Frequency range		20		1000	MHz
Gain	20-1000	46	50	55	dB
Gain Flatness	20-1000	—	—	±1.8	dB
Output Power at 1dB compression	20-1000	39	41	—	dBm
Output Power at 3dB compression	20-1000	40	43	—	dBm
Noise Figure	20-1000	—	3.5	—	dB
Output third order intercept point	20-1000	—	50	—	dBm
Input VSWR	20-1000	—	1.7	—	:1
Output VSWR	20-1000	—	2.5	—	:1
DC Supply Voltage		—	24*	—	V
Supply Current		—	—	2.8	A
SW Low (V _{IL}), RF ON		—	—	0.5	V
SW High (V _{IH}), RF OFF		2.7	5.0	—	V
SW Current		—	5	—	μA
Rise Time (SW ON to 90% RF)		—	—	50	μsec
Fall Time (SW OFF to 10% RF)		—	—	5	μsec

*Recommended Operating Voltage.

▲ Heat sink and fan not included. Alternative heat sinking and heat removal must be provided by the user to limit maximum base-plate temperature to 85°C, in order to ensure proper performance. For reference, this requires thermal resistance of user's external heat sink to be 0.3°C/W max.

MAXIMUM RATINGS

Parameter	Ratings
Operating Temperature	-20°C to 65°C
Storage Temperature	-55°C to 100°C
Base Plate Temperature	85°C
DC Voltage	28V
SW Voltage	10V
Input RF Power ¹ (no damage)	-3dBm

Permanent damage may occur if any of these limits are exceeded.

1. At nominal 50 Ohms RF load. Amplifier can withstand a full mismatch (short or open) across all phases at RF output, if the input RF power does not exceed -13dBm. Maximum RF input power is defined as a peak envelope power (PEP). See the application note AN-60-037 for PEP calculation.





COAXIAL, BUILT-IN RF SWITCH

High Power Amplifier

ZHL-20W-13SW+ ZHL-20W-13SWX+

50Ω 20W 20 to 1000 MHz

OUTLINE DRAWING FOR MODELS WITH HEATSINK AND FAN (ZHL-20W-13SW+)

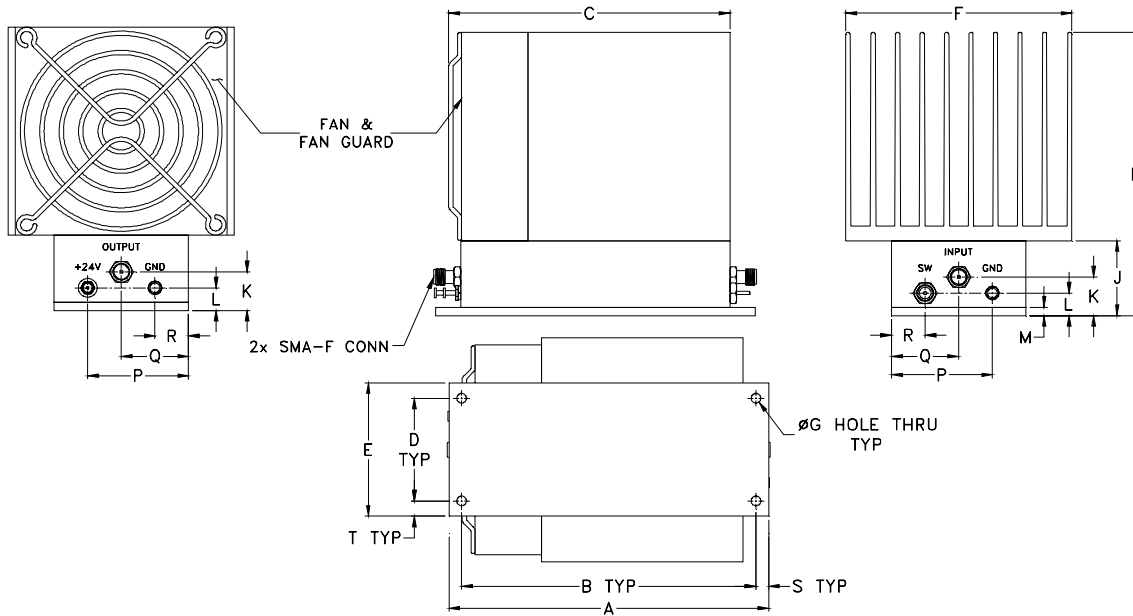

OUTLINE DRAWING FOR MODELS WITHOUT HEATSINK AND FAN (ZHL-20W-13SWX+)

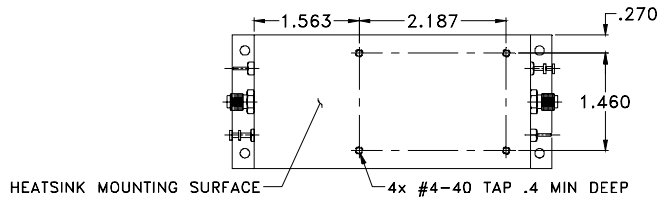

OUTLINE DIMENSIONS (MM/INCH)

A	B	C	D	E	F	G	H	J	K	L	M	P	Q	R	S	T	wt
4.75	4.375	4.18	1.540	2.00	3.36	.144	4.25	1.12	0.58	0.34	.13	1.50	1.00	.50	.19	.23	grams*
120.65	111.13	106.17	39.12	50.80	85.34	3.66	107.95	28.45	14.73	8.636	3.30	38.10	25.40	12.70	4.83	5.84	750

*290 grams without heatsink





COAXIAL, BUILT-IN RF SWITCH

High Power Amplifier

ZHL-20W-13SW+ ZHL-20W-13SWX+

50Ω 20W 20 to 1000 MHz

TYPICAL PERFORMANCE DATA/CURVES

Frequency (MHz)	Gain (dB)		VSWR (:1)		Noise Figure (dB)	Pout at 1 dB Compr. (dBm)	OIP3 (dBm)
	SW Low or Open ON	SW High OFF	IN	OUT	24V	24V	24V
20	51.98	-16.71	1.31	2.20	3.84	42.41	52.67
40	51.82	-11.19	1.27	2.21	3.76	42.89	53.14
60	51.75	-8.11	1.26	2.27	3.92	42.81	53.13
80	51.65	-6.21	1.28	2.36	3.91	42.96	53.25
100	51.60	-4.81	1.29	2.48	4.06	43.04	53.29
200	51.30	-1.08	1.36	3.09	4.34	43.19	52.59
250	51.28	0.14	1.38	3.24	4.12	42.81	51.99
300	51.33	1.27	1.39	3.20	3.95	42.54	51.58
350	51.50	2.40	1.38	2.99	3.77	42.34	51.68
450	51.96	4.51	1.37	2.30	3.90	42.14	52.77
500	52.21	5.48	1.34	2.00	3.74	42.30	51.70
550	52.41	6.35	1.33	1.80	3.83	42.30	50.53
600	52.61	7.17	1.29	1.73	3.85	42.22	49.93
650	52.77	7.95	1.25	1.76	3.89	42.10	49.41
750	52.77	9.22	1.16	1.96	3.90	41.93	48.86
800	52.45	9.45	1.12	2.11	3.84	41.78	48.44
850	51.95	9.73	1.11	2.27	3.78	41.72	48.10
900	51.26	9.83	1.10	2.40	3.76	41.64	47.73
950	50.78	10.09	1.09	2.32	3.74	41.32	47.13
1000	50.81	10.74	1.08	2.12	3.72	41.03	47.53

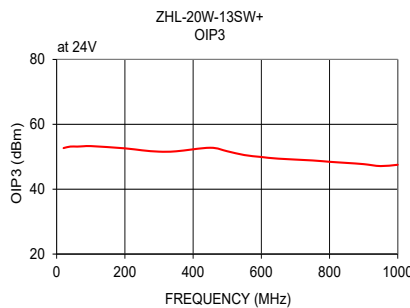
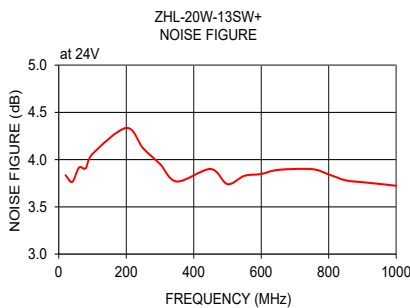
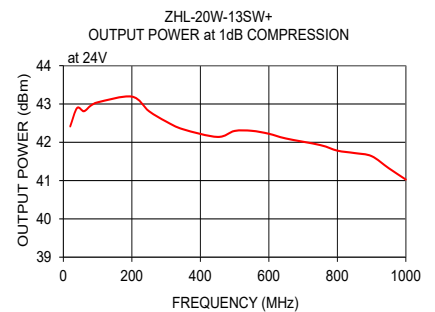
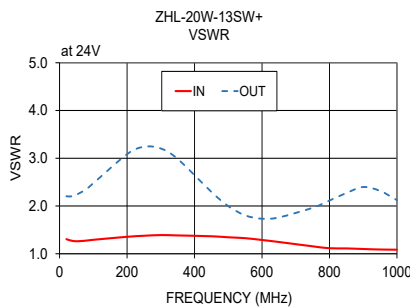
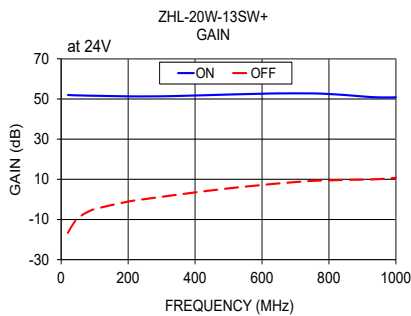

NOTES

- A. Performance and quality attributes and conditions not expressly stated in this specification document are intended to be excluded and do not form a part of this specification document.
- B. Electrical specifications and performance data contained in this specification document are based on Mini-Circuit's applicable established test performance criteria and measurement instructions.
- C. The parts covered by this specification document are subject to Mini-Circuits standard limited warranty and terms and conditions (collectively, "Standard Terms"); Purchasers of this part are entitled to the rights and benefits contained therein. For a full statement of the standard. Terms and the exclusive rights and remedies thereunder, please visit Mini-Circuits' website at www.minicircuits.com/terms/viewterm.html



Mouser Electronics

Authorized Distributor

Click to View Pricing, Inventory, Delivery & Lifecycle Information:

[Mini-Circuits:](#)

[ZHL-20W-13SW+](#)