

PT 2,5/ 3-5,0-H - PCB terminal block

1935789

<https://www.phoenixcontact.com/us/products/1935789>

Please be informed that the data shown in this PDF document is generated from our online catalog. Please find the complete data in the user documentation. Our general terms of use for downloads are valid.

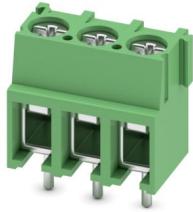

PCB terminal block, nominal current: 32 A, rated voltage (III/2): 400 V, nominal cross section: 2.5 mm², number of potentials: 3, number of rows: 1, number of positions per row: 3, product range: PT 2,5/..-H, pitch: 5 mm, connection method: Screw connection with wire protector, mounting: Wave soldering, conductor/PCB connection direction: 0 °, color: green, Pin layout: Linear pinning, Solder pin [P]: 4.1 mm, number of solder pins per potential: 1, type of packaging: packed in cardboard. When using ferrules, 250 V are only achieved in combination with overvoltage category/degree of pollution II/2.

Your advantages

- Well-known connection principle allows worldwide use
- Low temperature rise, thanks to maximum contact force
- High terminal block capacity thanks to rectangular terminal block space
- Allows connection of two conductors
- The latching on the side enables various numbers of positions to be combined

Commercial data

Item number	1935789
Packing unit	250 pc
Minimum order quantity	250 pc
Sales key	AA13
Product key	AAMFNA
Catalog page	Page 427 (C-1-2013)
GTIN	4017918948405
Weight per piece (including packing)	3.494 g
Weight per piece (excluding packing)	3.494 g
Customs tariff number	85369010
Country of origin	PL

PT 2,5/ 3-5,0-H - PCB terminal block



1935789

<https://www.phoenixcontact.com/us/products/1935789>

Technical data

Product properties

Type	PC termination block
Product line	COMBICON Terminals M
Product type	Printed circuit board terminal
Product family	PT 2,5/...-H
Number of positions	3
Pitch	5 mm
Number of connections	3
Number of rows	1
Number of potentials	3
Pin layout	Linear pinning
Solder pins per potential	1

Electrical properties

Nominal current I_N	32 A
Nominal voltage U_N	400 V
Degree of pollution	3
Rated voltage (III/3)	250 V
Rated surge voltage (III/3)	4 kV
Rated voltage (III/2)	400 V
Rated surge voltage (III/2)	4 kV
Rated voltage (II/2)	630 V
Rated surge voltage (II/2)	4 kV

Connection data

Connection technology

Type	PC termination block
Nominal cross section	2.5 mm ²

Conductor connection

Connection method	Screw connection with wire protector
Conductor cross section rigid	0.5 mm ² ... 4 mm ²
Conductor cross section flexible	0.5 mm ² ... 4 mm ²
Conductor cross section AWG	20 ... 10
Conductor cross section flexible, with ferrule without plastic sleeve	0.5 mm ² ... 2.5 mm ²
Conductor cross section, flexible, with ferrule, with plastic sleeve	0.5 mm ² ... 2.5 mm ²
2 conductors with same cross section, solid	0.5 mm ² ... 1.5 mm ²
2 conductors with same cross section, flexible	0.5 mm ² ... 1.5 mm ²
2 conductors with same cross section, flexible, with ferrule without plastic sleeve	0.5 mm ² ... 0.75 mm ²
2 conductors with the same cross section, flexible, with TWIN	0.5 mm ² ... 1.5 mm ²

PT 2,5/ 3-5,0-H - PCB terminal block



1935789

<https://www.phoenixcontact.com/us/products/1935789>

ferrule with plastic sleeve	
Stripping length	6.5 mm
Tightening torque	0.45 Nm ... 0.5 Nm

Mounting

Mounting type	Wave soldering
Pin layout	Linear pinning
Drive form screw head	Slotted Phillips recess
Connection method	Screw connection with wire protector
Drive form screw head	Slotted Phillips recess

Material specifications

Material data - contact

Note	WEEE/RoHS-compliant, free of whiskers according to IEC 60068-2-82/JEDEC JESD 201
Contact material	Cu alloy
Surface characteristics	Tin-plated
Metal surface terminal point (top layer)	Tin (3 - 12 µm Sn)
Metal surface terminal point (middle layer)	Nickel (1.5 - 4 µm Ni)
Metal surface soldering area (top layer)	Tin (3 - 12 µm Sn)
Metal surface soldering area (middle layer)	Nickel (1.5 - 4 µm Ni)

Material data - housing

Color (Housing)	green (6021)
Insulating material	PA
Insulating material group	I
CTI according to IEC 60112	600
Flammability rating according to UL 94	V0
Glow wire flammability index GWFI according to EN 60695-2-12	850
Glow wire ignition temperature GWIT according to EN 60695-2-13	775
Temperature for the ball pressure test according to EN 60695-10-2	125 °C

Notes

Note on application	For safe conductor connection, always adhere to a defined tightening torque. Particularly in the case of PCB terminal blocks with two or three positions, the individual solder pin for each contact point cannot compensate for this. That is why the terminal blocks must be supported during conductor connection (held with one hand, support on the housing).
---------------------	--

Dimensions

PT 2,5/ 3-5,0-H - PCB terminal block



1935789

<https://www.phoenixcontact.com/us/products/1935789>

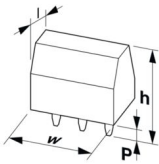
Dimensional drawing	
Pitch	5 mm
Width [w]	15 mm
Height [h]	17.6 mm
Length [l]	9 mm
Installed height	13.5 mm
Solder pin length [P]	4.1 mm
Pin dimensions	ø 1 mm

PCB design

Pin spacing	5 mm
Hole diameter	1.3 mm

Mechanical tests

Test for conductor damage and slackening

Specification	IEC 60999-1:1999-11
Result	Test passed

Pull-out test

Specification	IEC 60999-1:1999-11
Conductor cross section/conductor type/tractive force setpoint/actual value	0.5 mm ² / solid / > 20 N
	0.5 mm ² / flexible / > 20 N
	4 mm ² / solid / > 60 N
	4 mm ² / flexible / > 60 N

Electrical tests

Temperature-rise test

Specification	IEC 60947-7-4:2019-01
Requirement temperature-rise test	The sum of ambient temperature and temperature rise of the PCB terminal block shall not exceed the upper limiting temperature.

Short-time withstand current

Specification	IEC 60947-7-4:2019-01
---------------	-----------------------

Insulation resistance

Specification	IEC 60512-3-1:2002-02
Insulation resistance, neighboring positions	> 5 MΩ

Air clearances and creepage distances |

Specification	IEC 60947-1:2007-06 + A1:2010-12 + A2:2014-09
---------------	---

PT 2,5/ 3-5,0-H - PCB terminal block



1935789

<https://www.phoenixcontact.com/us/products/1935789>

Insulating material group	I
Comparative tracking index (IEC 60112)	CTI 600
Rated insulation voltage (III/3)	250 V
Rated surge voltage (III/3)	4 kV
minimum clearance value - non-homogenous field (III/3)	3 mm
minimum creepage distance (III/3)	3.2 mm
Rated insulation voltage (III/2)	400 V
Rated surge voltage (III/2)	4 kV
minimum clearance value - non-homogenous field (III/2)	3 mm
minimum creepage distance (III/2)	3 mm
Rated insulation voltage (II/2)	630 V
Rated surge voltage (II/2)	4 kV
minimum clearance value - non-homogenous field (II/2)	3 mm
minimum creepage distance (II/2)	3.2 mm

Environmental and real-life conditions

Vibration test

Specification	IEC 60068-2-6:2007-12
Frequency	10 - 150 - 10 Hz
Sweep speed	1 octave/min
Amplitude	0.35 mm (10 Hz ... 60.1 Hz)
Sweep speed	5g (60.1 Hz ... 150 Hz)
Test duration per axis	2.5 h

Glow-wire test

Specification	IEC 60695-2-10:2013-04
Temperature	850 °C
Time of exposure	5 s

Aging

Specification	IEC 60947-7-4:2019-01
---------------	-----------------------

Ambient conditions

Ambient temperature (operation)	-40 °C ... 105 °C (Depending on the current carrying capacity/derating curve)
Ambient temperature (storage/transport)	-40 °C ... 70 °C
Relative humidity (storage/transport)	30 % ... 70 %
Ambient temperature (assembly)	-5 °C ... 100 °C

Packaging specifications

Type of packaging	packed in cardboard
-------------------	---------------------

PT 2,5/ 3-5,0-H - PCB terminal block

1935789

<https://www.phoenixcontact.com/us/products/1935789>

Drawings

Dimensional drawing

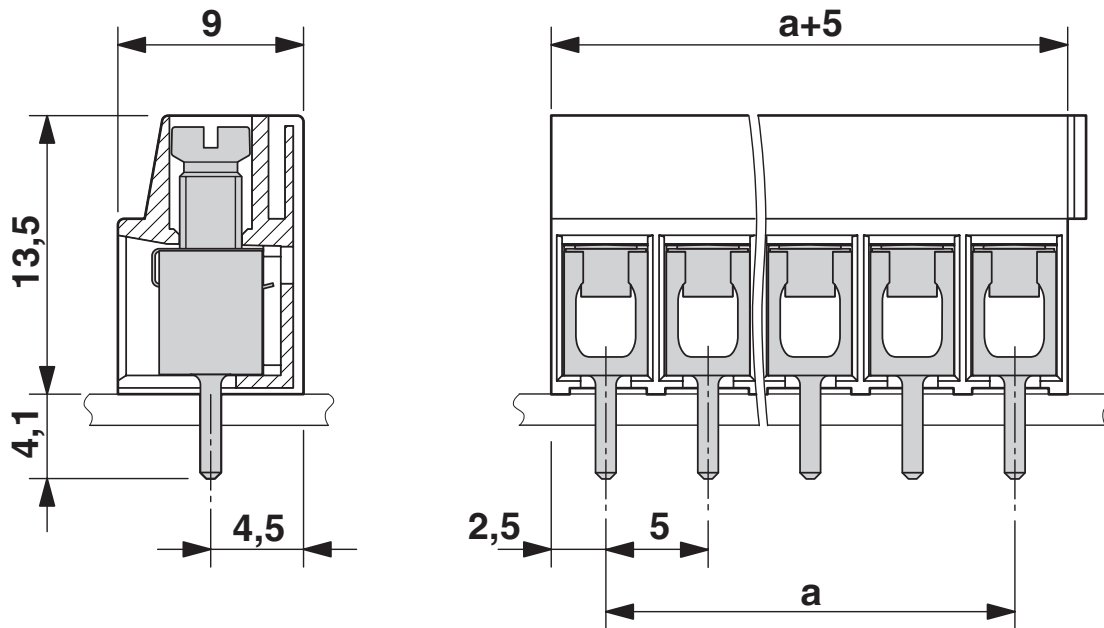

Diagram

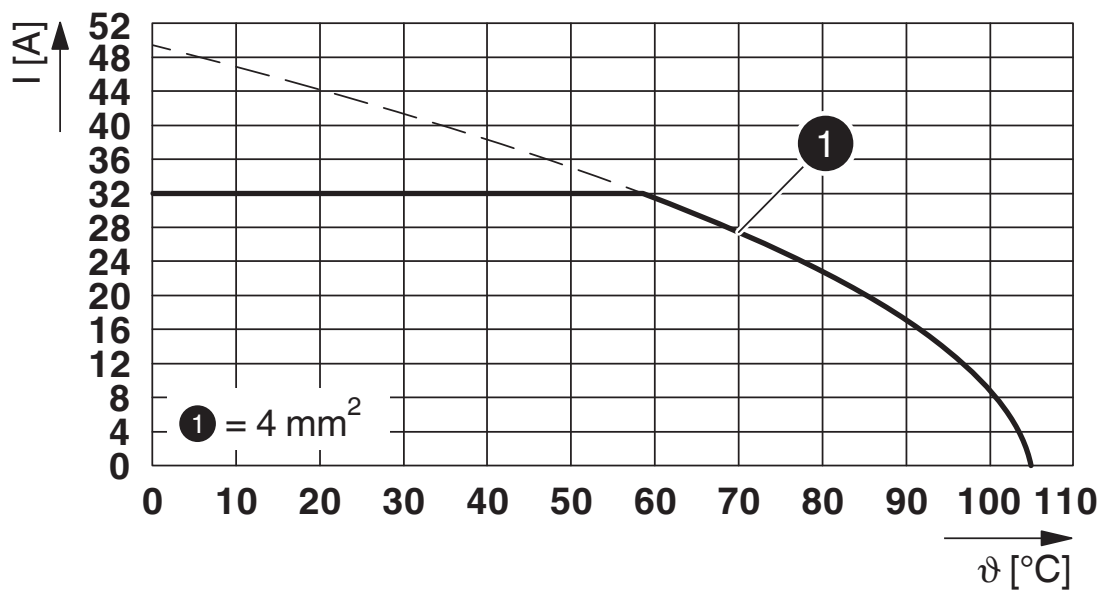

Type: PT 2,5/...-5,0-H

PT 2,5/ 3-5,0-H - PCB terminal block

1935789

<https://www.phoenixcontact.com/us/products/1935789>



Drilling plan/solder pad geometry

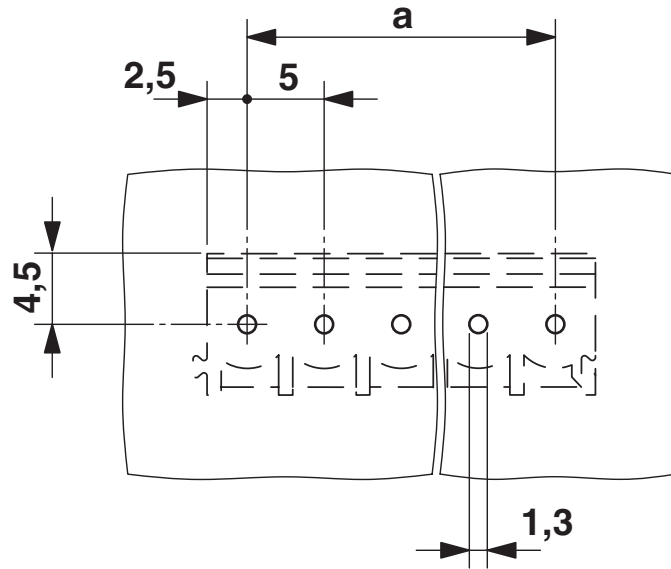

PT 2,5/ 3-5,0-H - PCB terminal block





1935789

<https://www.phoenixcontact.com/us/products/1935789>

Approvals

To download certificates, visit the product detail page: <https://www.phoenixcontact.com/us/products/1935789>

 cULus Recognized Approval ID: E60425-20030211				
	Nominal voltage U_N	Nominal current I_N	Cross section AWG	Cross section mm^2
Use group B	300 V	20 A	20 - 12	-
Use group D	300 V	10 A	20 - 12	-

 VDE Gutachten mit Fertigungsüberwachung Approval ID: 40029839				
	Nominal voltage U_N	Nominal current I_N	Cross section AWG	Cross section mm^2
	250 V	32 A	-	0.5 - 4

PT 2,5/ 3-5,0-H - PCB terminal block



1935789

<https://www.phoenixcontact.com/us/products/1935789>

Classifications

ECLASS

ECLASS-11.0	27460101
ECLASS-12.0	27460101
ECLASS-13.0	27460101

ETIM

ETIM 9.0	EC002643
----------	----------

UNSPSC

UNSPSC 21.0	39121400
-------------	----------

PT 2,5/ 3-5,0-H - PCB terminal block



1935789

<https://www.phoenixcontact.com/us/products/1935789>

Environmental product compliance

REACH SVHC	Lead 7439-92-1
China RoHS	Environmentally Friendly Use Period = 50 years
	For information on hazardous substances, refer to the manufacturer's declaration available under "Downloads"

PT 2,5/ 3-5,0-H - PCB terminal block



1935789

<https://www.phoenixcontact.com/us/products/1935789>

Accessories

SZS 0,6X3,5 - Screwdriver

1205053

<https://www.phoenixcontact.com/us/products/1205053>



Actuation tool, for ST terminal blocks, insulated, also suitable for use as a bladed screwdriver, size: 0.6 x 3.5 x 100 mm, 2-component grip, with non-slip grip

SK 5/3,8:FORTL.ZAHLEN - Marker card

0804183

<https://www.phoenixcontact.com/us/products/0804183>



Marker card, white, labeled, horizontal: consecutive numbers 1 ... 10, 11 ... 20, etc. up to 91 ... (99)100, mounting type: adhesive, for terminal block width: 5 mm, lettering field size: 5 x 3.8 mm

Phoenix Contact 2024 © - all rights reserved

<https://www.phoenixcontact.com>

Phoenix Contact USA

586 Fulling Mill Road

Middletown, PA 17057, United States

(+717) 944-1300

info@phoenixcon.com