

# FRONT-MSTB 2,5/10-ST - PCB connector



1779495

<https://www.phoenixcontact.com/us/products/1779495>

Please be informed that the data shown in this PDF document is generated from our online catalog. Please find the complete data in the user documentation. Our general terms of use for downloads are valid.

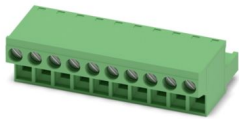

PCB connector, nominal cross section: 2.5 mm<sup>2</sup>, color: green, nominal current: 12 A, rated voltage (III/2): 320 V, contact surface: Tin, contact connection type: Socket, number of potentials: 10, number of rows: 1, number of positions: 10, number of connections: 10, product range: FRONT-MSTB 2,5/..-ST, pitch: 5 mm, connection method: Front screw connection, screw head form: L Slotted, conductor/PCB connection direction: 0 °, locking clip: - Locking clip, plug-in system: COMBICON MSTB 2,5, locking: without, mounting: without, type of packaging: packed in cardboard

## Your advantages

- Well-known connection principle allows worldwide use
- Optimized for tight installation situations: operation and conductor connection from one direction
- Low temperature rise, thanks to maximum contact force
- Allows connection of two conductors

## Commercial data

Item number	1779495
Packing unit	50 pc
Minimum order quantity	50 pc
Note	Made to order (non-returnable)
Sales key	AA03
Product key	AACAAA
Catalog page	Page 269 (C-1-2013)
GTIN	4017918040185
Weight per piece (including packing)	30.58 g
Weight per piece (excluding packing)	30.532 g
Customs tariff number	85366990
Country of origin	DE

# FRONT-MSTB 2,5/10-ST - PCB connector



1779495

<https://www.phoenixcontact.com/us/products/1779495>

## Technical data

### Product properties

Type	Standard
Product line	COMBICON Connectors M
Product type	PCB connector
Product family	FRONT-MSTB 2,5/..-ST
Number of positions	10
Pitch	5 mm
Number of connections	10
Number of rows	1
Mounting flange	without
Number of potentials	10

### Electrical properties

Nominal current $I_N$	12 A
Nominal voltage $U_N$	320 V
Degree of pollution	3
Contact resistance	1.7 m $\Omega$
Rated voltage (III/3)	250 V
Rated surge voltage (III/3)	4 kV
Rated voltage (III/2)	320 V
Rated surge voltage (III/2)	4 kV
Rated voltage (II/2)	630 V
Rated surge voltage (II/2)	4 kV

### Connection data

#### Connection technology

Type	Standard
Connector system	COMBICON MSTB 2,5
Nominal cross section	2.5 mm <sup>2</sup>
Contact connection type	Socket

#### Interlock

Locking type	without
Mounting flange	without

#### Conductor connection

Connection method	Front screw connection
Conductor/PCB connection direction	0 °
Conductor cross section rigid	0.34 mm <sup>2</sup> ... 2.5 mm <sup>2</sup>
Conductor cross section flexible	0.2 mm <sup>2</sup> ... 2.5 mm <sup>2</sup>
Conductor cross section AWG	24 ... 12
Conductor cross section flexible, with ferrule without plastic	0.25 mm <sup>2</sup> ... 2.5 mm <sup>2</sup>

# FRONT-MSTB 2,5/10-ST - PCB connector



1779495

<https://www.phoenixcontact.com/us/products/1779495>

sleeve	
Conductor cross section, flexible, with ferrule, with plastic sleeve	0.25 mm <sup>2</sup> ... 2.5 mm <sup>2</sup>
2 conductors with same cross section, solid	0.2 mm <sup>2</sup> ... 1.5 mm <sup>2</sup>
2 conductors with same cross section, flexible	0.2 mm <sup>2</sup> ... 1.5 mm <sup>2</sup>
2 conductors with same cross section, flexible, with ferrule without plastic sleeve	0.25 mm <sup>2</sup> ... 1 mm <sup>2</sup>
2 conductors with the same cross section, flexible, with TWIN ferrule with plastic sleeve	0.5 mm <sup>2</sup> ... 1 mm <sup>2</sup>
Cylindrical gauge a x b / diameter	2.8 mm x 2.0 mm / 2.4 mm
Stripping length	10 mm
Tightening torque	0.5 Nm ... 0.6 Nm

## Specifications for ferrules without insulating collar

recommended crimping tool	1212034 CRIMPFOX 6
---------------------------	--------------------

## Material specifications

### Material data - contact

Note	WEEE/RoHS-compliant, free of whiskers according to IEC 60068-2-82/JEDEC JESD 201
Contact material	Cu alloy
Surface characteristics	hot-dip tin-plated
Metal surface terminal point (top layer)	Tin (4 - 8 µm Sn)
Metal surface contact area (top layer)	Tin (4 - 8 µm Sn)

### Material data - housing

Color (Housing)	green (6021)
Insulating material	PA
Insulating material group	I
CTI according to IEC 60112	600
Flammability rating according to UL 94	V0
Glow wire flammability index GWFI according to EN 60695-2-12	850
Glow wire ignition temperature GWIT according to EN 60695-2-13	775
Temperature for the ball pressure test according to EN 60695-10-2	125 °C

## Dimensions

Dimensional drawing	
Pitch	5 mm
Width [w]	50 mm
Height [h]	15 mm

# FRONT-MSTB 2,5/10-ST - PCB connector



1779495

<https://www.phoenixcontact.com/us/products/1779495>

Length [l]	27.2 mm
------------	---------

## Mounting

Drive form screw head	Slotted (L)
Drive form screw head	Slotted (L)

## Notes

Notes on operation	In accordance with IEC 61984, COMBICON connectors have no switching power (COC). During designated use, they must not be plugged in or disconnected when carrying voltage or under load.
--------------------	--

## Mechanical tests

### Test for conductor damage and slackening

Specification	IEC 60999-1:1999-11
Result	Test passed

### Pull-out test

Specification	IEC 60999-1:1999-11
Conductor cross section/conductor type/tractive force setpoint/actual value	0.34 mm <sup>2</sup> / solid / > 15 N
	0.2 mm <sup>2</sup> / flexible / > 10 N
	2.5 mm <sup>2</sup> / solid / > 50 N
	2.5 mm <sup>2</sup> / flexible / > 50 N

### Insertion and withdrawal forces

Result	Test passed
No. of cycles	25
Insertion strength per pos. approx.	8 N
Withdraw strength per pos. approx.	6 N

### Torque test

Specification	IEC 60999-1:1999-11
---------------	---------------------

### Resistance of inscriptions

Specification	IEC 60068-2-70:1995-12
Result	Test passed

### Polarization and coding

Specification	IEC 60512-13-5:2006-02
Result	Test passed

### Visual inspection

Specification	IEC 60512-1-1:2002-02
Result	Test passed

### Dimension check

Specification	IEC 60512-1-2:2002-02
Result	Test passed

# FRONT-MSTB 2,5/10-ST - PCB connector



1779495

<https://www.phoenixcontact.com/us/products/1779495>

## Environmental and real-life conditions

### Vibration test

Specification	IEC 60068-2-6:2007-12
Frequency	10 - 150 - 10 Hz
Sweep speed	1 octave/min
Amplitude	0.35 mm (10 Hz ... 60.1 Hz)
Sweep speed	5g (60.1 Hz ... 150 Hz)
Test duration per axis	2.5 h

### Durability test

Specification	IEC 60512-9-1:2010-03
Impulse withstand voltage at sea level	4.8 kV
Contact resistance $R_1$	1.7 m $\Omega$
Contact resistance $R_2$	1.8 m $\Omega$
Insertion/withdrawal cycles	25
Insulation resistance, neighboring positions	> 5 M $\Omega$

### Climatic test

Specification	ISO 6988:1985-02
Corrosive stress	0.2 dm <sup>3</sup> SO <sub>2</sub> on 300 dm <sup>3</sup> /40 °C/1 cycle
Thermal stress	100 °C/168 h
Power-frequency withstand voltage	2.21 kV

### Ambient conditions

Ambient temperature (operation)	-40 °C ... 100 °C (dependent on the derating curve)
Ambient temperature (storage/transport)	-40 °C ... 70 °C
Relative humidity (storage/transport)	30 % ... 70 %
Ambient temperature (assembly)	-5 °C ... 100 °C

## Electrical tests

### Thermal test | Test group C

Specification	IEC 60512-5-1:2002-02
Tested number of positions	24

### Insulation resistance

Specification	IEC 60512-3-1:2002-02
Insulation resistance, neighboring positions	> 5 M $\Omega$

### Air clearances and creepage distances |

Specification	IEC 60664-1:2007-04
Insulating material group	I
Comparative tracking index (IEC 60112)	CTI 600
Rated insulation voltage (III/3)	250 V
Rated surge voltage (III/3)	4 kV

# FRONT-MSTB 2,5/10-ST - PCB connector



1779495

<https://www.phoenixcontact.com/us/products/1779495>

minimum clearance value - non-homogenous field (III/3)	3 mm
minimum creepage distance (III/3)	3.2 mm
Rated insulation voltage (III/2)	320 V
Rated surge voltage (III/2)	4 kV
minimum clearance value - non-homogenous field (III/2)	3 mm
minimum creepage distance (III/2)	3 mm
Rated insulation voltage (II/2)	630 V
Rated surge voltage (II/2)	4 kV
minimum clearance value - non-homogenous field (II/2)	3 mm
minimum creepage distance (II/2)	3.2 mm

## Packaging specifications

Type of packaging	packed in cardboard
-------------------	---------------------

1779495

<https://www.phoenixcontact.com/us/products/1779495>

## Drawings

Diagram

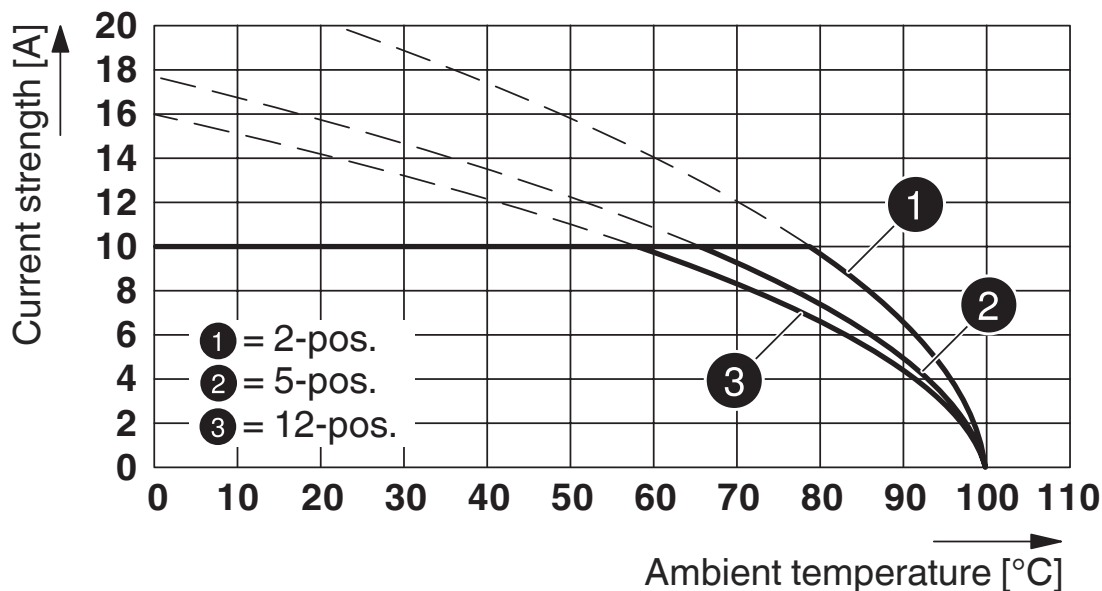

Type: FRONT-MSTB 2,5/...-ST with MDSTBA 2,5/...-G

Diagram

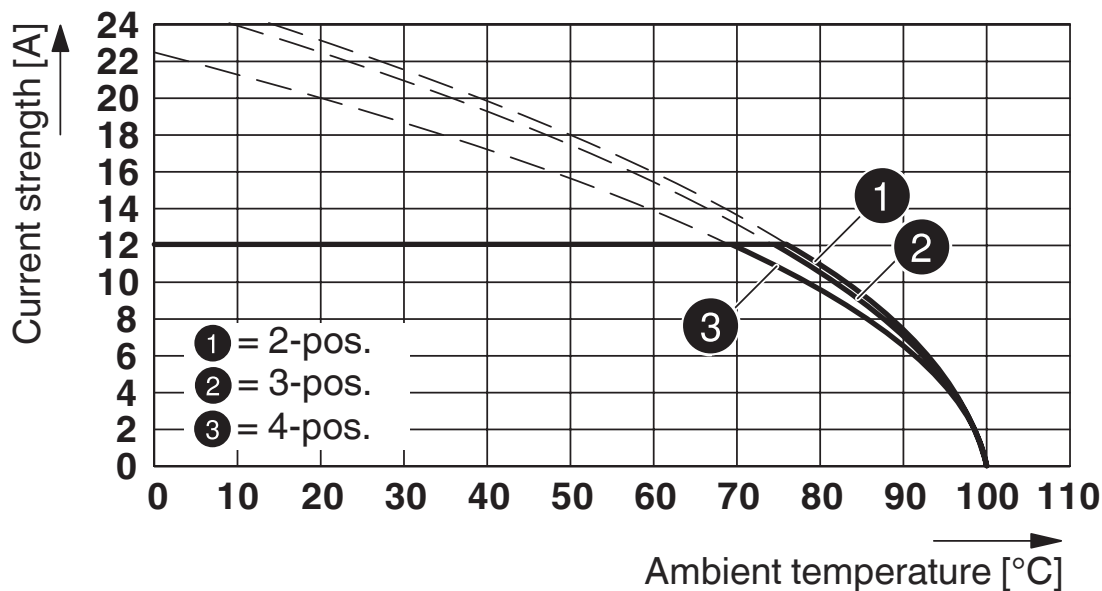

Type: FRONT-MSTB 2,5/...-ST with MSTBO 2,5/...-G1R

# FRONT-MSTB 2,5/10-ST - PCB connector

1779495

<https://www.phoenixcontact.com/us/products/1779495>

Dimensional drawing

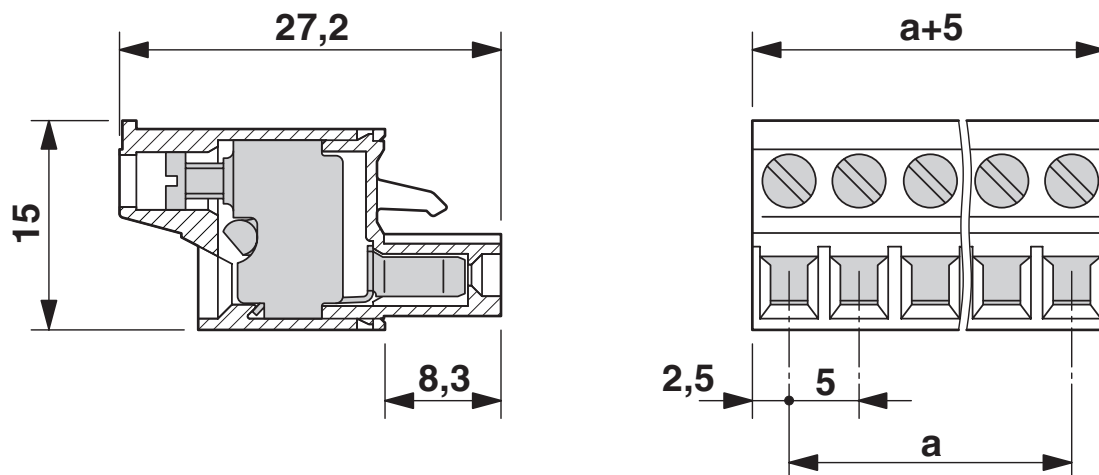

Diagram

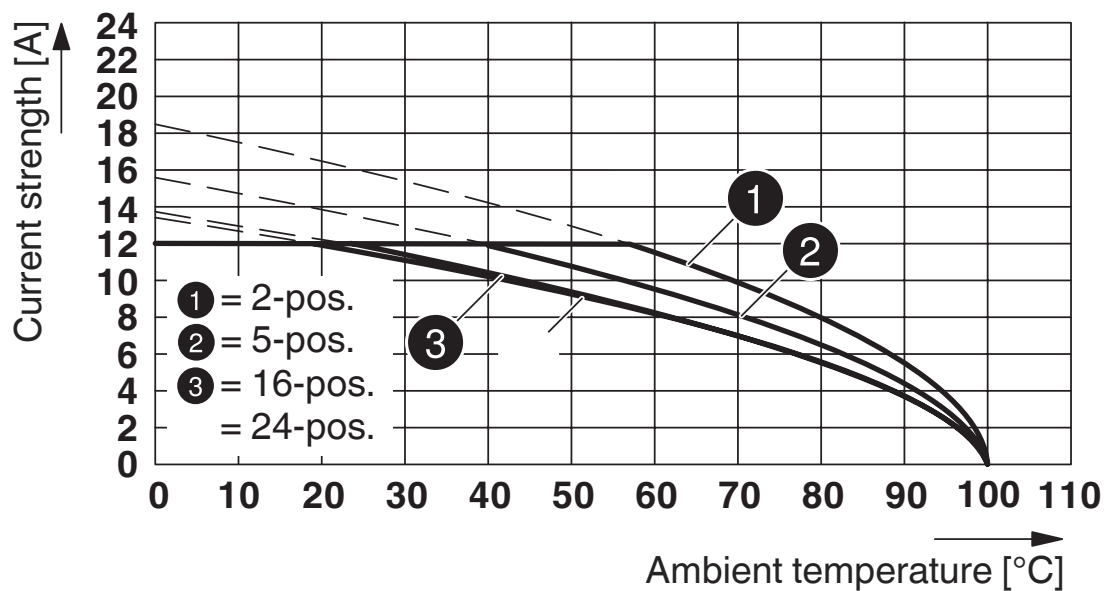

Type: FRONT-MSTB 2,5/...-ST with MSTBV 2,5/...-G



1779495

<https://www.phoenixcontact.com/us/products/1779495>

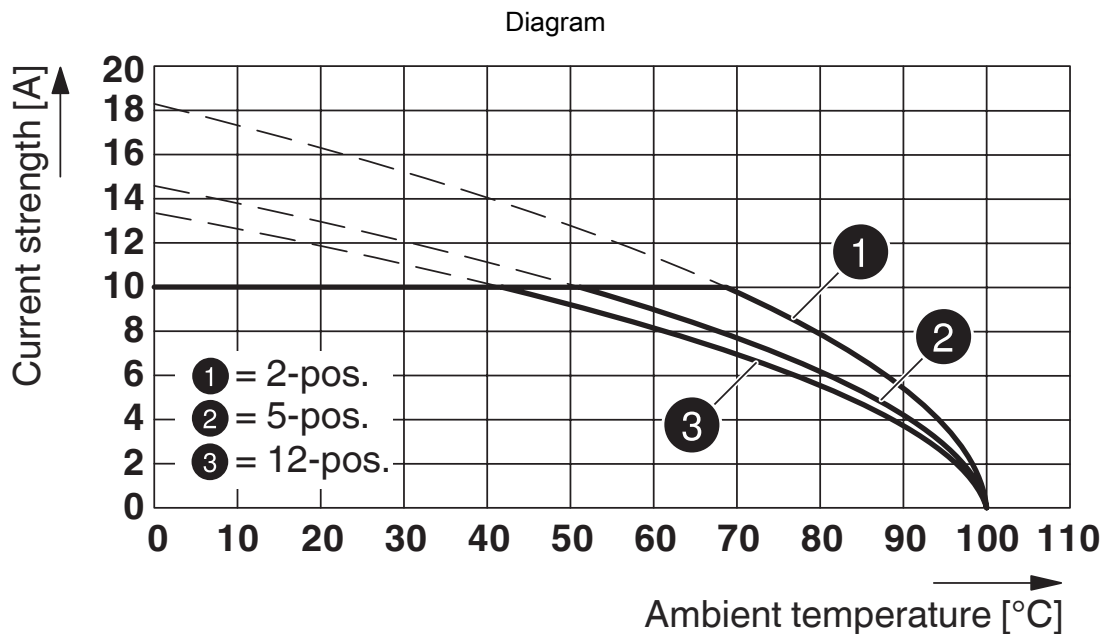

Type: FRONT-MSTB 2,5/...-ST with MDSTBVA 2,5/...-G

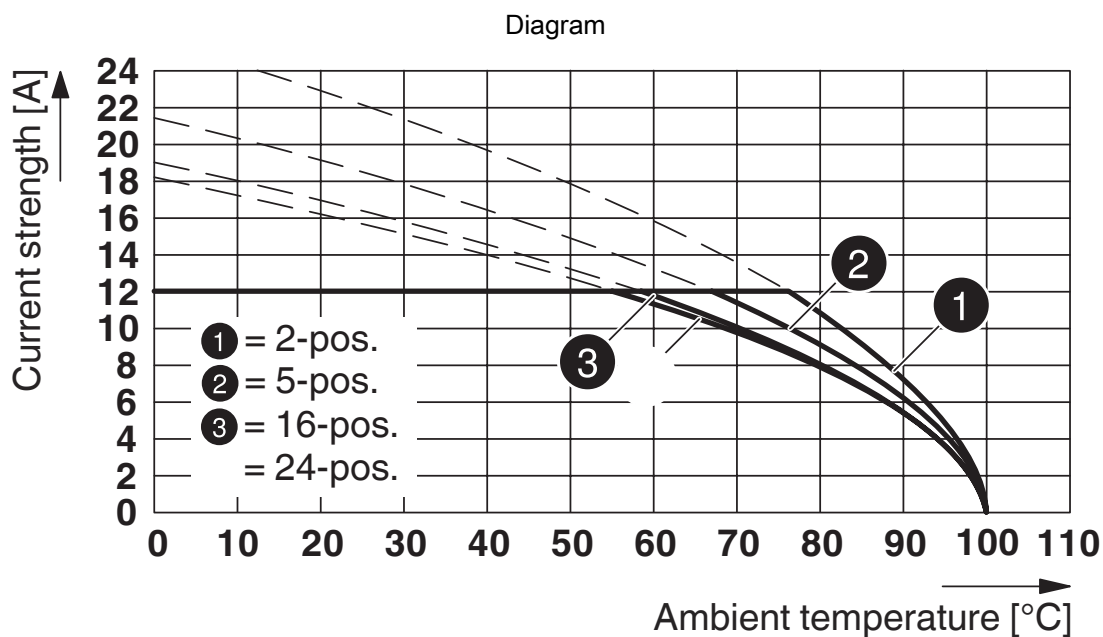

Type: FRONT-MSTB 2,5/...-ST with SMSTB 2,5/...-G

# FRONT-MSTB 2,5/10-ST - PCB connector



1779495

<https://www.phoenixcontact.com/us/products/1779495>

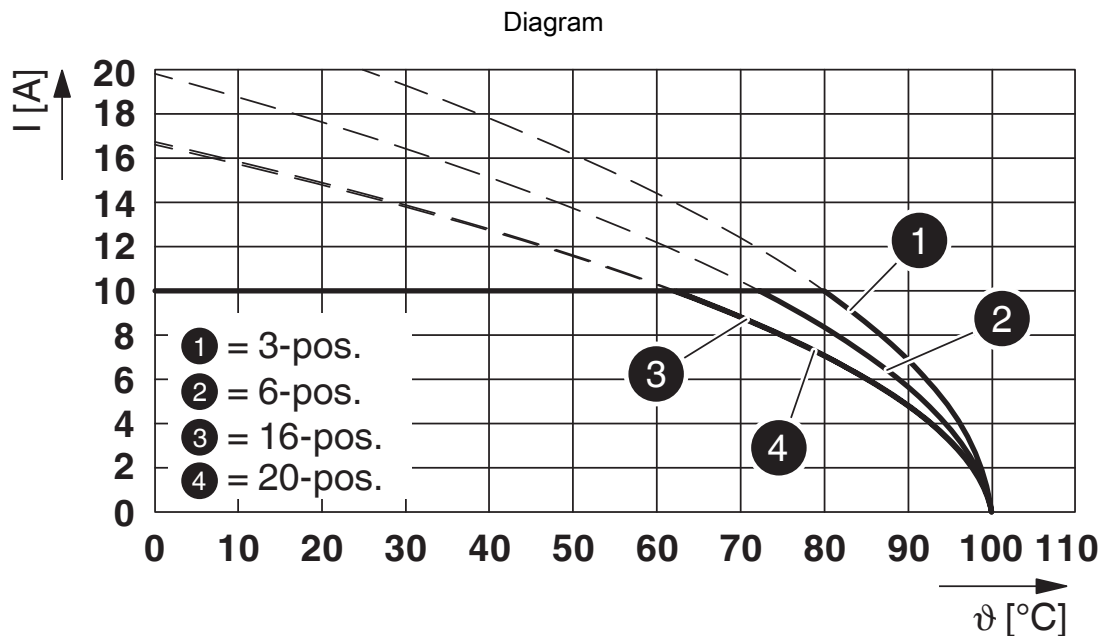

Type: FRONT-MSTB 2,5/...-ST with MDSTBV 2,5/...-G1

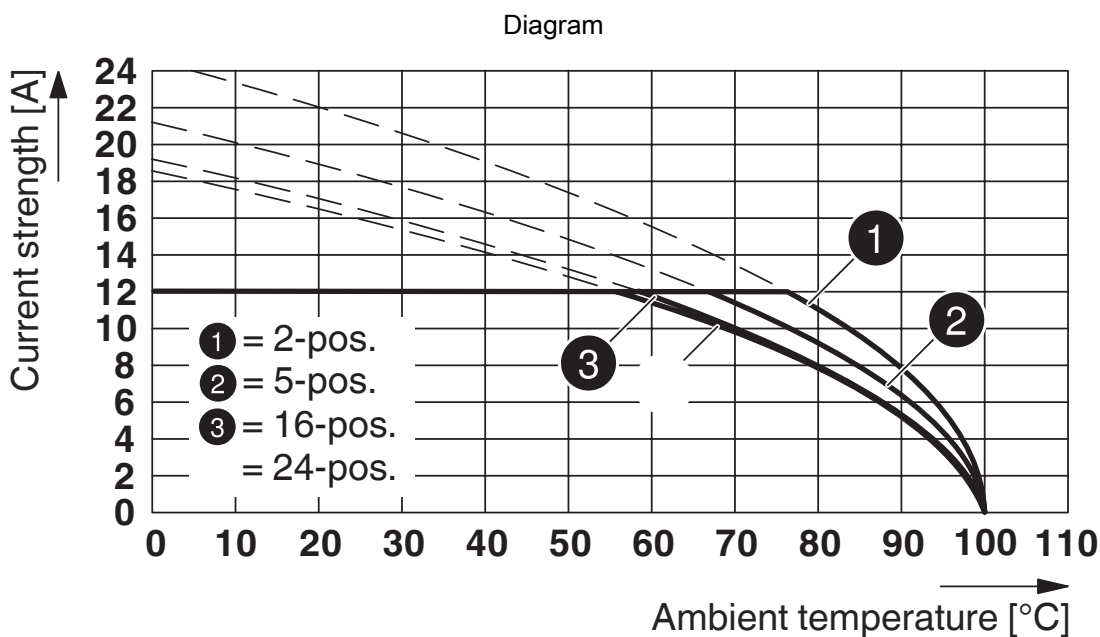

Type: FRONT-MSTB 2,5/...-ST with SMSTBA 2,5/...-G

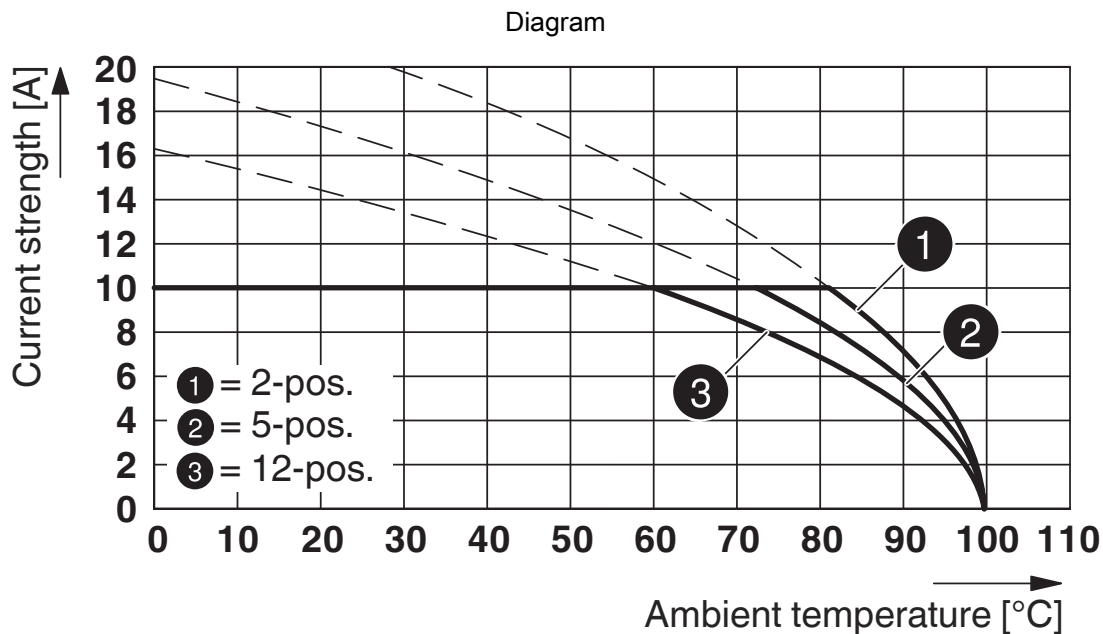

Type: FRONT-MSTB 2,5/...-ST with MDSTB 2,5/...-G

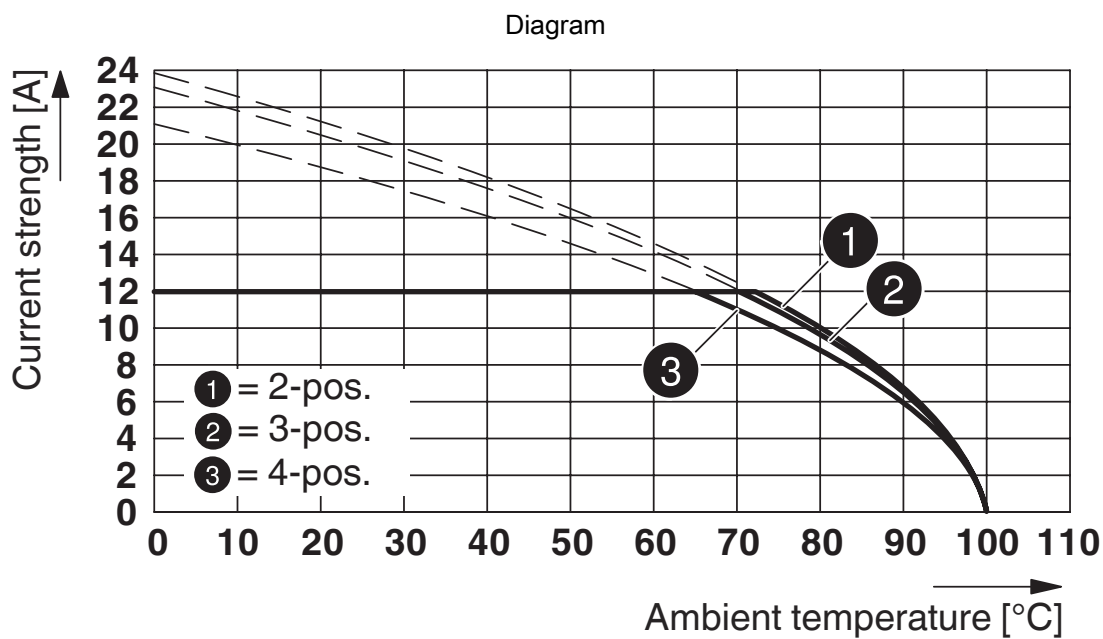

Type: FRONT-MSTB 2,5/...-ST with MSTBO 2,5/...-G1L

1779495

<https://www.phoenixcontact.com/us/products/1779495>

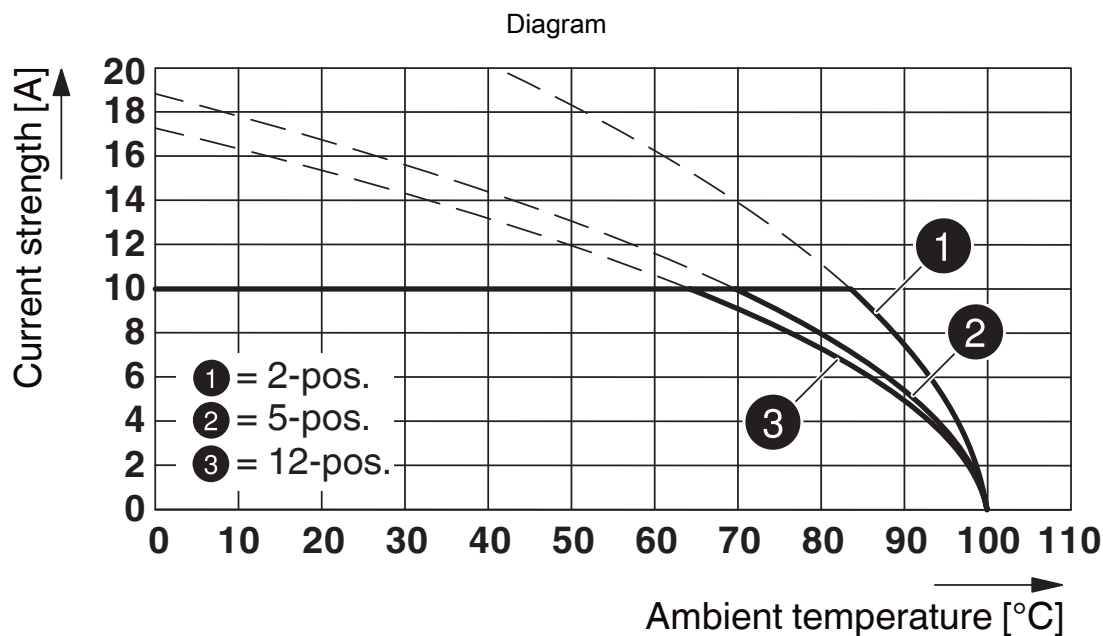

Type: FRONT-MSTB 2,5/...-ST with MDSTBV 2,5/...-G

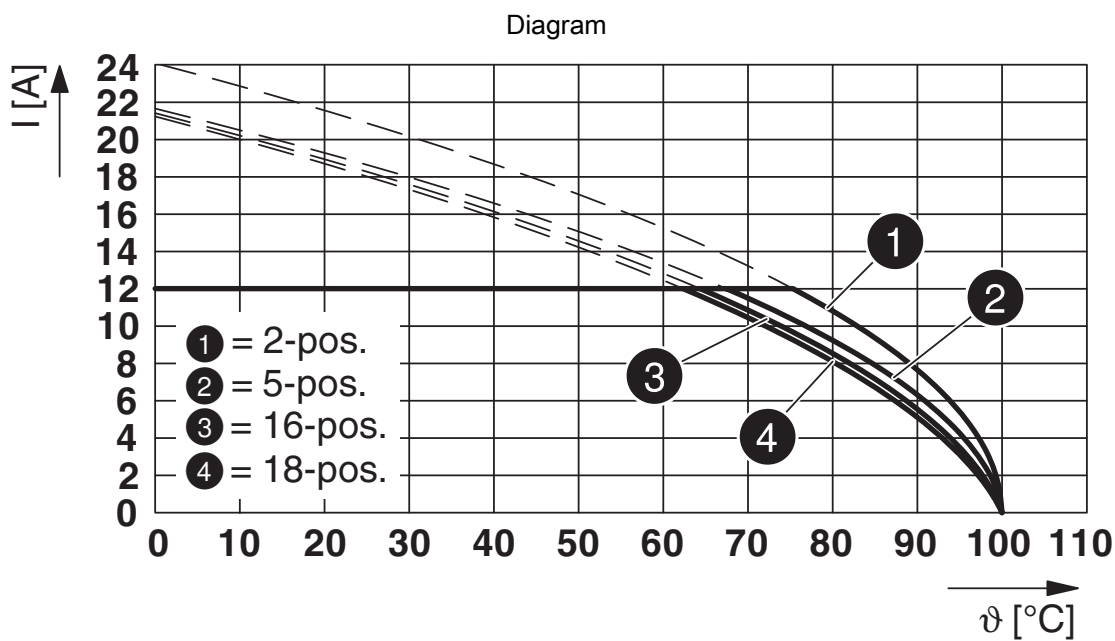

Type: FRONT-MSTB 2,5/...-ST with FKIC 2,5/...-ST

1779495

<https://www.phoenixcontact.com/us/products/1779495>

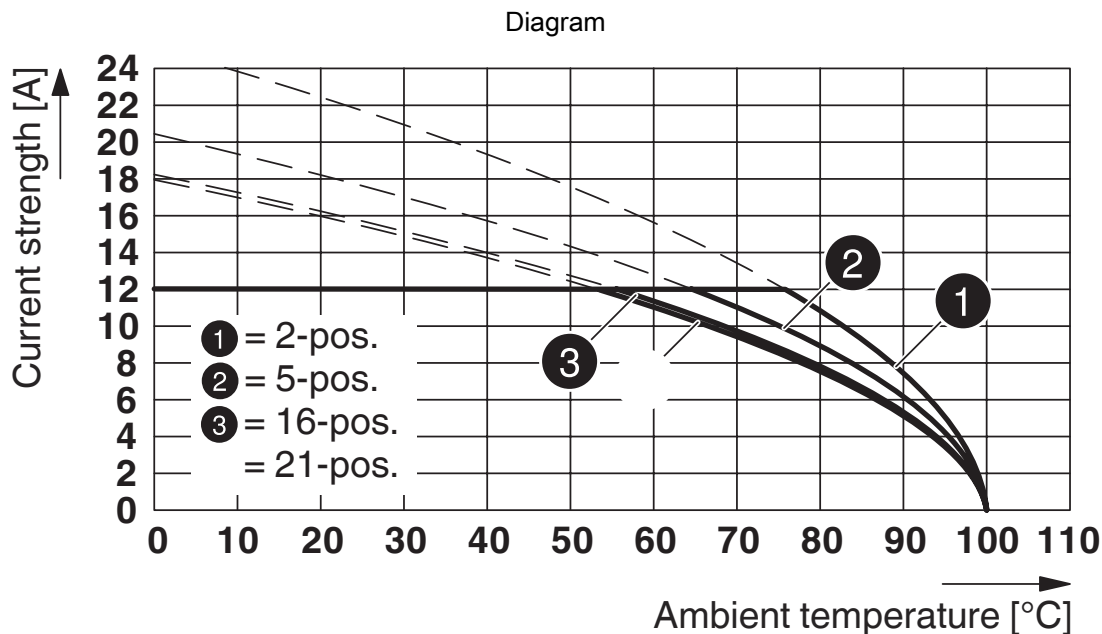

Type: FRONT-MSTB 2,5/...-ST with MSTBW 2,5/...-G

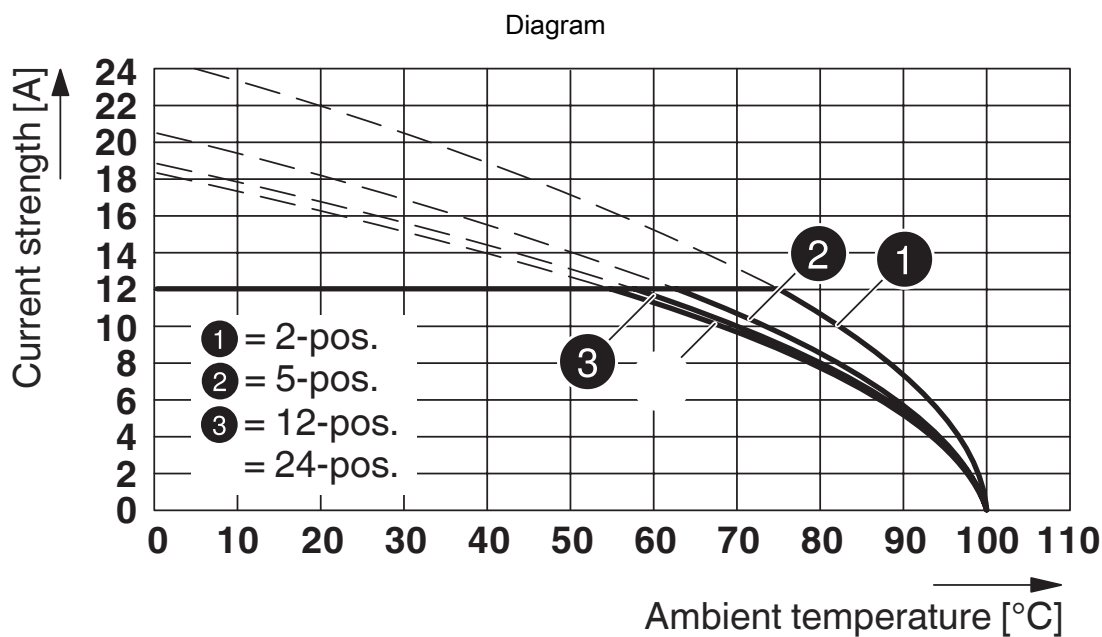

Type: FRONT-MSTB 2,5/...-ST with MSTB 2,5/...-G

# FRONT-MSTB 2,5/10-ST - PCB connector



1779495

<https://www.phoenixcontact.com/us/products/1779495>

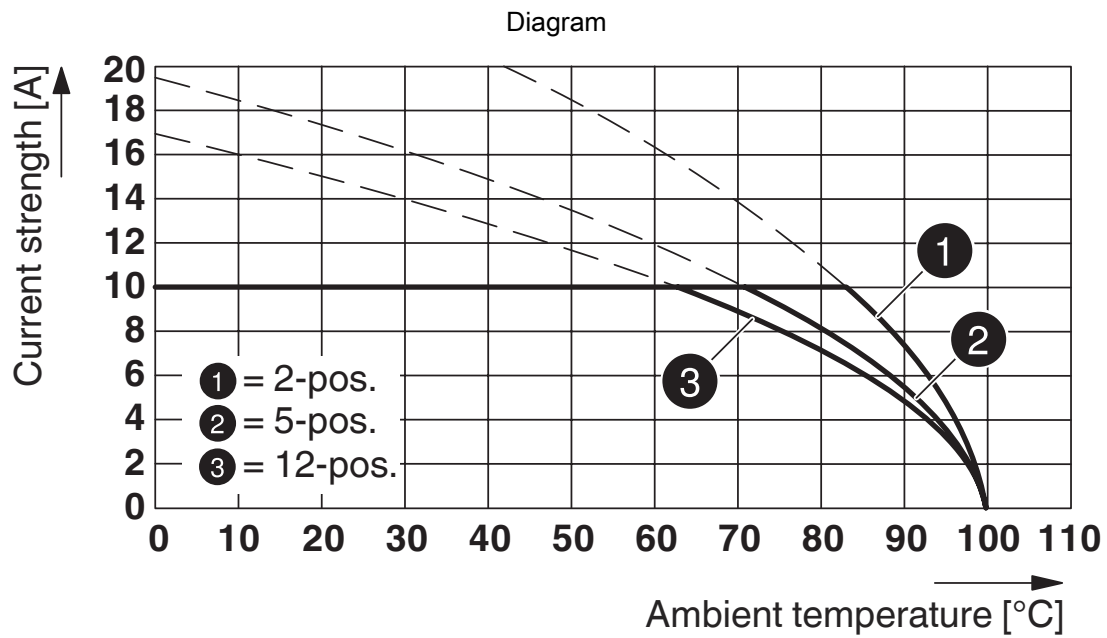

Type: FRONT-MSTB 2,5/...-ST with MDSTBW 2,5/...-G

# FRONT-MSTB 2,5/10-ST - PCB connector





1779495

<https://www.phoenixcontact.com/us/products/1779495>

## Approvals

To download certificates, visit the product detail page: <https://www.phoenixcontact.com/us/products/1779495>

 <b>CSA</b> Approval ID: 13631				
	Nominal voltage $U_N$	Nominal current $I_N$	Cross section AWG	Cross section $\text{mm}^2$
Use group B				
	300 V	15 A	22 - 12	-
Use group D				
	300 V	10 A	22 - 12	-

 <b>cULus Recognized</b> Approval ID: E60425-19931011				
	Nominal voltage $U_N$	Nominal current $I_N$	Cross section AWG	Cross section $\text{mm}^2$
Use group B				
	300 V	15 A	30 - 12	-
Use group D				
	300 V	10 A	30 - 12	-

 <b>VDE Zeichengenehmigung</b> Approval ID: 40004701				
	Nominal voltage $U_N$	Nominal current $I_N$	Cross section AWG	Cross section $\text{mm}^2$
	250 V	12 A	-	0.34 - 2.5

# FRONT-MSTB 2,5/10-ST - PCB connector



1779495

<https://www.phoenixcontact.com/us/products/1779495>

## Classifications

### ECLASS

ECLASS-11.0	27460202
ECLASS-12.0	27460202
ECLASS-13.0	27460202

### ETIM

ETIM 9.0	EC002638
----------	----------

### UNSPSC

UNSPSC 21.0	39121400
-------------	----------



# FRONT-MSTB 2,5/10-ST - PCB connector



1779495

<https://www.phoenixcontact.com/us/products/1779495>

## Environmental product compliance

China RoHS	Environmentally friendly use period: unlimited = EFUP-e
	No hazardous substances above threshold values

# FRONT-MSTB 2,5/10-ST - PCB connector

1779495

<https://www.phoenixcontact.com/us/products/1779495>

## Accessories

 Note: Applying some accessories below might limit this product.

### EBL 10- 5 - Insertion bridge

2303132

<https://www.phoenixcontact.com/us/products/2303132>

Insertion bridge, pitch: 5.2 mm, number of positions: 10, color: gray

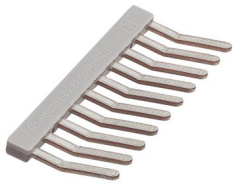

 Max. current carrying capacity: 24 A

---

### EBL 2- 5 - Insertion bridge

2303145

<https://www.phoenixcontact.com/us/products/2303145>

Insertion bridge, pitch: 5.2 mm, number of positions: 2, color: gray



 Max. current carrying capacity: 24 A

# FRONT-MSTB 2,5/10-ST - PCB connector

1779495

<https://www.phoenixcontact.com/us/products/1779495>

## EBL 3- 5 - Insertion bridge

2303158

<https://www.phoenixcontact.com/us/products/2303158>

Insertion bridge, pitch: 5.2 mm, number of positions: 3, color: gray

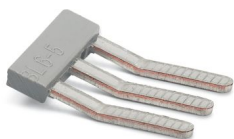

 Max. current carrying capacity: 24 A

---

## EBL 4- 5 - Insertion bridge

2303161

<https://www.phoenixcontact.com/us/products/2303161>

Insertion bridge, pitch: 5.2 mm, number of positions: 4, color: gray

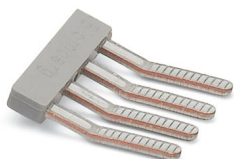

 Max. current carrying capacity: 24 A

# FRONT-MSTB 2,5/10-ST - PCB connector



1779495

<https://www.phoenixcontact.com/us/products/1779495>

## FRONT-MSTB-EW - Accessories

1763058

<https://www.phoenixcontact.com/us/products/1763058>



Removal aid, for FRONT-MSTB, facilitates extraction of several plugs mounted behind each other

---

## SK 5/3,8:FORTL.ZAHLEN - Marker card

0804183

<https://www.phoenixcontact.com/us/products/0804183>



Marker card, white, labeled, horizontal: consecutive numbers 1 ... 10, 11 ... 20, etc. up to 91 ... (99)100, mounting type: adhesive, for terminal block width: 5 mm, lettering field size: 5 x 3.8 mm

# FRONT-MSTB 2,5/10-ST - PCB connector



1779495

<https://www.phoenixcontact.com/us/products/1779495>

## CP-MSTB - Coding profile

1734634

<https://www.phoenixcontact.com/us/products/1734634>

Coding profile, is inserted into the slot on the plug or inverted header, red insulating material



---

## SK 5/3,8:UNBEDRUCKT - Marker card

0805409

<https://www.phoenixcontact.com/us/products/0805409>

Marker card, Sheet, white, unlabeled, can be labeled with: Marker pen: without print, mounting type: adhesive, for terminal block width: 5 mm, lettering field size: 5 x 3.8 mm, Number of individual labels: 120



# FRONT-MSTB 2,5/10-ST - PCB connector



1779495

<https://www.phoenixcontact.com/us/products/1779495>

## MSTBW 2,5/10-G - PCB header

1736030

<https://www.phoenixcontact.com/us/products/1736030>

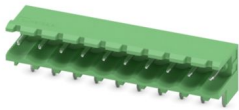

PCB headers, nominal cross section: 2.5 mm<sup>2</sup>, color: green, nominal current: 12 A, rated voltage (III/2): 320 V, contact surface: Tin, contact connection type: Pin, number of potentials: 10, number of rows: 1, number of positions: 10, number of connections: 10, product range: MSTBW 2,5/..-G, pitch: 5 mm, mounting: Wave soldering, pin layout: Linear pinning, solder pin [P]: 3.5 mm, number of solder pins per potential: 1, plug-in system: COMBICON MSTB 2,5, Pin connector pattern alignment: Standard, locking: without, mounting: without, type of packaging: packed in cardboard

## MSTBV 2,5/10-G - PCB header

1753592

<https://www.phoenixcontact.com/us/products/1753592>

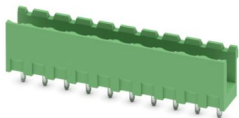

PCB headers, nominal cross section: 2.5 mm<sup>2</sup>, color: green, nominal current: 12 A, rated voltage (III/2): 320 V, contact surface: Tin, contact connection type: Pin, number of potentials: 10, number of rows: 1, number of positions: 10, number of connections: 10, product range: MSTBV 2,5/..-G, pitch: 5 mm, mounting: Wave soldering, pin layout: Linear pinning, solder pin [P]: 3.9 mm, number of solder pins per potential: 1, plug-in system: COMBICON MSTB 2,5, Pin connector pattern alignment: Standard, locking: without, mounting: without, type of packaging: packed in cardboard

# FRONT-MSTB 2,5/10-ST - PCB connector

1779495

<https://www.phoenixcontact.com/us/products/1779495>

## MDSTBV 2,5/10-G - PCB header

1846014

<https://www.phoenixcontact.com/us/products/1846014>

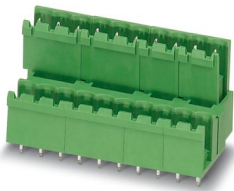

PCB headers, nominal cross section: 2.5 mm<sup>2</sup>, color: green, nominal current: 10 A, rated voltage (III/2): 320 V, contact surface: Tin, contact connection type: Pin, number of potentials: 20, number of rows: 2, number of positions: 10, number of connections: 20, product range: MDSTBV 2,5/...-G, pitch: 5 mm, mounting: Wave soldering, pin layout: Linear pinning, solder pin [P]: 3.9 mm, number of solder pins per potential: 1, plug-in system: COMBICON MSTB 2,5, Pin connector pattern alignment: Standard, locking: without, mounting: without, type of packaging: packed in cardboard, Can be aligned! Mounting flange: Item No. 1836477, 1836480. In combination with MVSTB or FKCV plug components, both an MVSTBW (or FKCVW) and an MVSTBR plug (or FKCVR) must be used. Combination with TMSTBP plug components is not possible!

## MDSTB 2,5/10-G - PCB header

1846441

<https://www.phoenixcontact.com/us/products/1846441>

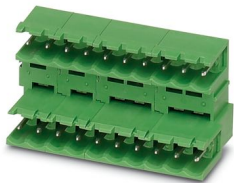

PCB headers, nominal cross section: 2.5 mm<sup>2</sup>, color: green, nominal current: 10 A, rated voltage (III/2): 320 V, contact surface: Tin, contact connection type: Pin, number of potentials: 20, number of rows: 2, number of positions: 10, number of connections: 20, product range: MDSTB 2,5/...-G, pitch: 5 mm, mounting: Wave soldering, pin layout: Linear pinning, solder pin [P]: 3.23 mm, number of solder pins per potential: 1, plug-in system: COMBICON MSTB 2,5, Pin connector pattern alignment: Standard, locking: without, mounting: without, type of packaging: packed in cardboard, Can be aligned! Mounting flange: Item No. 1736771, 1736768. In combination with MVSTB or FKCV plug components, both an MVSTBW (or FKCVW) and an MVSTBR plug (or FKCVR) must be used. Combination with TMSTBP plug components is not possible!

# FRONT-MSTB 2,5/10-ST - PCB connector



1779495

<https://www.phoenixcontact.com/us/products/1779495>

## MDSTBA 2,5/10-G - PCB header

1846593

<https://www.phoenixcontact.com/us/products/1846593>

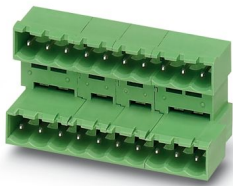

PCB headers, nominal cross section: 2.5 mm<sup>2</sup>, color: green, nominal current: 10 A, rated voltage (III/2): 320 V, contact surface: Tin, contact connection type: Pin, number of potentials: 20, number of rows: 2, number of positions: 10, number of connections: 20, product range: MDSTBA 2,5/...-G, pitch: 5 mm, mounting: Wave soldering, pin layout: Linear pinning, solder pin [P]: 3.23 mm, number of solder pins per potential: 1, plug-in system: COMBICON MSTB 2,5, Pin connector pattern alignment: Standard, locking: without, mounting: without, type of packaging: packed in cardboard, The article can be aligned to create different nos. of positions! In combination with MVSTB or FKCV plug components, both an MVSTBW (or FKCVW) and an MVSTBR plug (or FKCVR) must be used. Combination with TMSTBP plug components is not possible!

---

Phoenix Contact 2024 © - all rights reserved  
<https://www.phoenixcontact.com>

Phoenix Contact USA  
586 Fulling Mill Road  
Middletown, PA 17057, United States  
(+717) 944-1300  
[info@phoenixcon.com](mailto:info@phoenixcon.com)