

# FKCN 2,5/ 4-ST - PCB connector



1732768

<https://www.phoenixcontact.com/us/products/1732768>

Please be informed that the data shown in this PDF document is generated from our online catalog. Please find the complete data in the user documentation. Our general terms of use for downloads are valid.

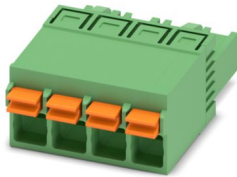

PCB connector, nominal cross section: 2.5 mm<sup>2</sup>, color: green, nominal current: 12 A, rated voltage (III/2): 320 V, contact surface: Tin, contact connection type: Socket, number of potentials: 4, number of rows: 1, number of positions: 4, number of connections: 4, product range: FKCN 2,5/..-ST, pitch: 5 mm, connection method: Push-in spring connection, conductor/PCB connection direction: 0 °, locking clip: - Locking clip, plug-in system: COMBICON MSTB 2,5, locking: without, mounting: without, type of packaging: packed in cardboard

## Your advantages

- Time saving push-in connection, tools not required
- Intuitive operation due to color-coded actuating push button
- Extremely small design for the respective conductor cross section
- Defined contact force ensures that contact remains stable over the long term
- Can be combined with the MSTB 2,5 range

## Commercial data

Item number	1732768
Packing unit	50 pc
Minimum order quantity	50 pc
Sales key	AA03
Product key	AACFEA
Catalog page	Page 278 (C-1-2013)
GTIN	4046356163651
Weight per piece (including packing)	5.517 g
Weight per piece (excluding packing)	5 g
Customs tariff number	85366990
Country of origin	BG

# FKCN 2,5/ 4-ST - PCB connector



1732768

<https://www.phoenixcontact.com/us/products/1732768>

## Technical data

### Product properties

Type	Standard
Product line	COMBICON Connectors M
Product type	PCB connector
Product family	FKCN 2,5/...-ST
Number of positions	4
Pitch	5 mm
Number of connections	4
Number of rows	1
Mounting flange	without
Number of potentials	4

### Electrical properties

Nominal current $I_N$	12 A
Nominal voltage $U_N$	320 V
Degree of pollution	3
Contact resistance	1.1 m $\Omega$
Rated voltage (III/3)	320 V
Rated surge voltage (III/3)	4 kV
Rated voltage (III/2)	320 V
Rated surge voltage (III/2)	4 kV
Rated voltage (II/2)	630 V
Rated surge voltage (II/2)	4 kV

### Connection data

#### Connection technology

Type	Standard
Connector system	COMBICON MSTB 2,5
Nominal cross section	2.5 mm <sup>2</sup>
Contact connection type	Socket

#### Interlock

Locking type	without
Mounting flange	without

#### Conductor connection

Connection method	Push-in spring connection
Conductor/PCB connection direction	0 °
Conductor cross section rigid	0.2 mm <sup>2</sup> ... 1.5 mm <sup>2</sup>
Conductor cross section flexible	0.2 mm <sup>2</sup> ... 2.5 mm <sup>2</sup>
Conductor cross section AWG	24 ... 16
Conductor cross section flexible, with ferrule without plastic	0.25 mm <sup>2</sup> ... 1.5 mm <sup>2</sup>

# FKCN 2,5/ 4-ST - PCB connector

1732768

<https://www.phoenixcontact.com/us/products/1732768>

sleeve	
Conductor cross section, flexible, with ferrule, with plastic sleeve	0.25 mm <sup>2</sup> ... 1.5 mm <sup>2</sup>
Cylindrical gauge a x b / diameter	2.4 mm x 1.5 mm / 1.6 mm
Stripping length	10 mm

## Specifications for ferrules without insulating collar

recommended crimping tool	1212034 CRIMPFOX 6
---------------------------	--------------------

## Material specifications

### Material data - contact

Note	WEEE/RoHS-compliant, free of whiskers according to IEC 60068-2-82/JEDEC JESD 201
Contact material	Cu alloy
Surface characteristics	hot-dip tin-plated
Metal surface terminal point (top layer)	Tin (4 - 8 µm Sn)
Metal surface contact area (top layer)	Tin (4 - 8 µm Sn)

### Material data - housing

Color (Housing)	green (6021)
Insulating material	PBT
Insulating material group	I
CTI according to IEC 60112	600
Flammability rating according to UL 94	V0

### Material data - actuating element

Color (Actuating element)	orange (2003)
Insulating material	PA
Insulating material group	I
CTI according to IEC 60112	600
Flammability rating according to UL 94	V0

## Dimensions

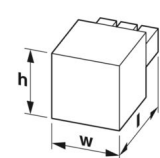
Dimensional drawing	
Pitch	5 mm
Width [w]	20 mm
Height [h]	10.9 mm
Length [l]	27.1 mm

## Mounting

Connection method	Push-in spring connection
-------------------	---------------------------

# FKCN 2,5/ 4-ST - PCB connector



1732768

<https://www.phoenixcontact.com/us/products/1732768>

## Notes

Notes on operation	In accordance with IEC 61984, COMBICON connectors have no switching power (COC). During designated use, they must not be plugged in or disconnected when carrying voltage or under load.
--------------------	--

## Mechanical tests

### Conductor connection

Specification	IEC 60999-1:1999-11
Result	Test passed

### Test for conductor damage and slackening

Specification	IEC 60999-1:1999-11
Result	Test passed

### Repeated connection and disconnection

Specification	IEC 60999-1:1999-11
Result	Test passed

### Pull-out test

Specification	IEC 60999-1:1999-11
Conductor cross section/conductor type/tractive force setpoint/actual value	0.2 mm <sup>2</sup> / solid / > 10 N
	0.2 mm <sup>2</sup> / flexible / > 10 N
	1.5 mm <sup>2</sup> / solid / > 40 N
	2.5 mm <sup>2</sup> / flexible / > 50 N

### Insertion and withdrawal forces

Result	Test passed
No. of cycles	25
Insertion strength per pos. approx.	8 N
Withdraw strength per pos. approx.	6 N

### Resistance of inscriptions

Specification	IEC 60068-2-70:1995-12
Result	Test passed

### Polarization and coding

Specification	IEC 60512-13-5:2006-02
Result	Test passed

### Visual inspection

Specification	IEC 60512-1-1:2002-02
Result	Test passed

### Dimension check

Specification	IEC 60512-1-2:2002-02
Result	Test passed

# FKCN 2,5/ 4-ST - PCB connector



1732768

<https://www.phoenixcontact.com/us/products/1732768>

## Environmental and real-life conditions

### Vibration test

Specification	IEC 60068-2-6:2007-12
Frequency	10 - 150 - 10 Hz
Sweep speed	1 octave/min
Amplitude	0.35 mm (10 Hz ... 60.1 Hz)
Sweep speed	5g (60.1 Hz ... 150 Hz)
Test duration per axis	2.5 h

### Durability test

Specification	IEC 60512-9-1:2010-03
Impulse withstand voltage at sea level	4.8 kV
Contact resistance $R_1$	1.1 m $\Omega$
Contact resistance $R_2$	1.1 m $\Omega$
Insertion/withdrawal cycles	25
Insulation resistance, neighboring positions	> 5 M $\Omega$

### Climatic test

Specification	ISO 6988:1985-02
Corrosive stress	0.2 dm <sup>3</sup> SO <sub>2</sub> on 300 dm <sup>3</sup> /40 °C/1 cycle
Thermal stress	100 °C/168 h
Power-frequency withstand voltage	2.21 kV

### Ambient conditions

Ambient temperature (operation)	-40 °C ... 100 °C (dependent on the derating curve)
Ambient temperature (storage/transport)	-40 °C ... 70 °C
Relative humidity (storage/transport)	30 % ... 70 %
Ambient temperature (assembly)	-5 °C ... 100 °C

## Electrical tests

### Thermal test | Test group C

Specification	IEC 60512-5-1:2002-02
Tested number of positions	18

### Insulation resistance

Specification	IEC 60512-3-1:2002-02
Insulation resistance, neighboring positions	> 5 M $\Omega$

### Air clearances and creepage distances |

Specification	IEC 60664-1:2007-04
Insulating material group	I
Comparative tracking index (IEC 60112)	CTI 600
Rated insulation voltage (III/3)	320 V
Rated surge voltage (III/3)	4 kV

# FKCN 2,5/ 4-ST - PCB connector



1732768

<https://www.phoenixcontact.com/us/products/1732768>

minimum clearance value - non-homogenous field (III/3)	3 mm
minimum creepage distance (III/3)	4 mm
Rated insulation voltage (III/2)	320 V
Rated surge voltage (III/2)	4 kV
minimum clearance value - non-homogenous field (III/2)	3 mm
minimum creepage distance (III/2)	3 mm
Rated insulation voltage (II/2)	630 V
Rated surge voltage (II/2)	4 kV
minimum clearance value - non-homogenous field (II/2)	3 mm
minimum creepage distance (II/2)	3.2 mm

## Packaging specifications

Type of packaging	packed in cardboard
-------------------	---------------------

# FKCN 2,5/ 4-ST - PCB connector



1732768

<https://www.phoenixcontact.com/us/products/1732768>

## Drawings

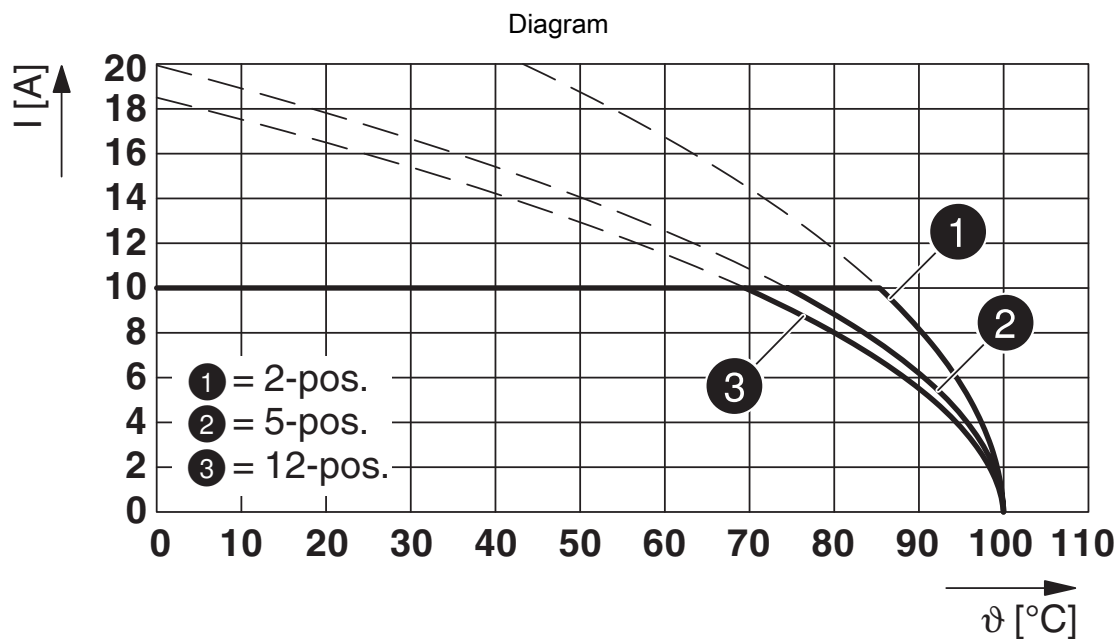

Type: FKCN 2,5/...-ST with MDSTB 2,5/...-G

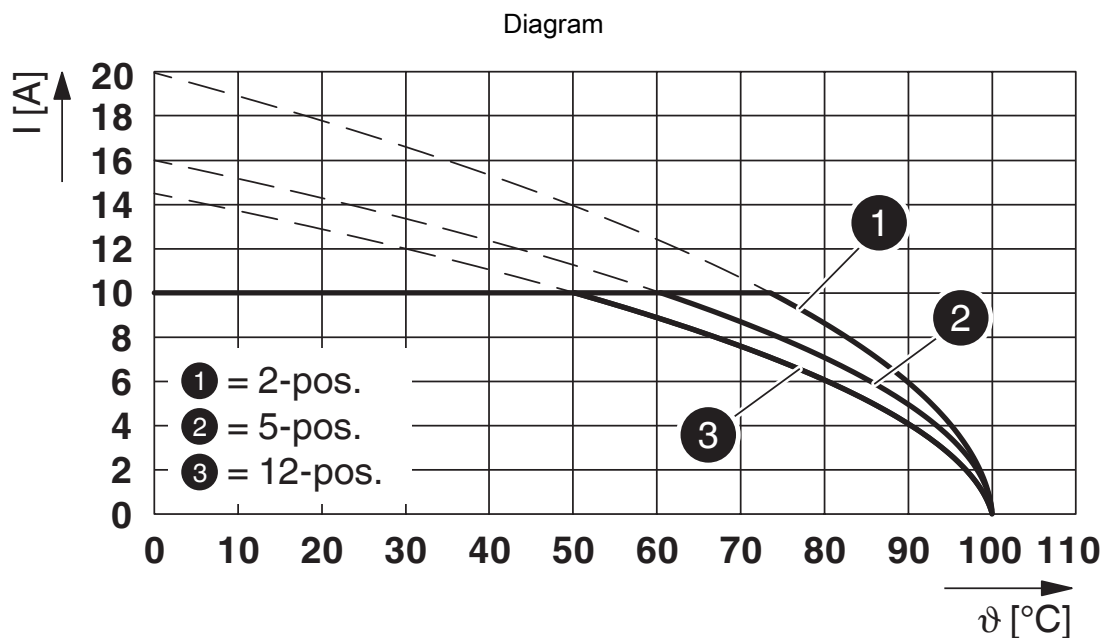

Type: FKCN 2,5/...-ST with MDSTBVA 2,5/...-G

# FKCN 2,5/ 4-ST - PCB connector



1732768

<https://www.phoenixcontact.com/us/products/1732768>

Diagram

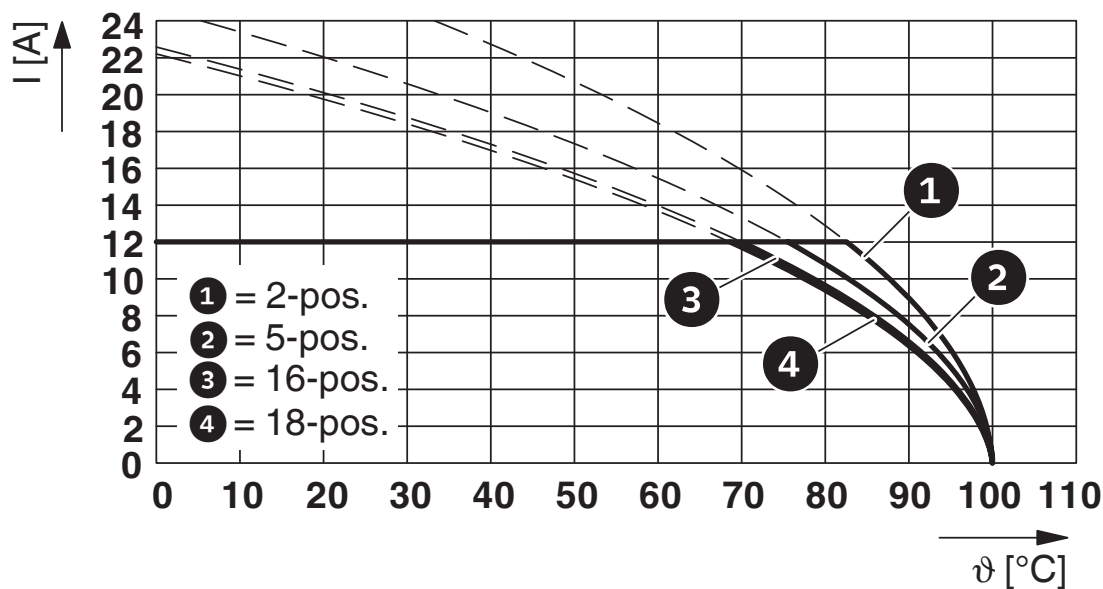

Type: FKCN 2,5/...-ST with SMSTB 2,5/...-G

Diagram

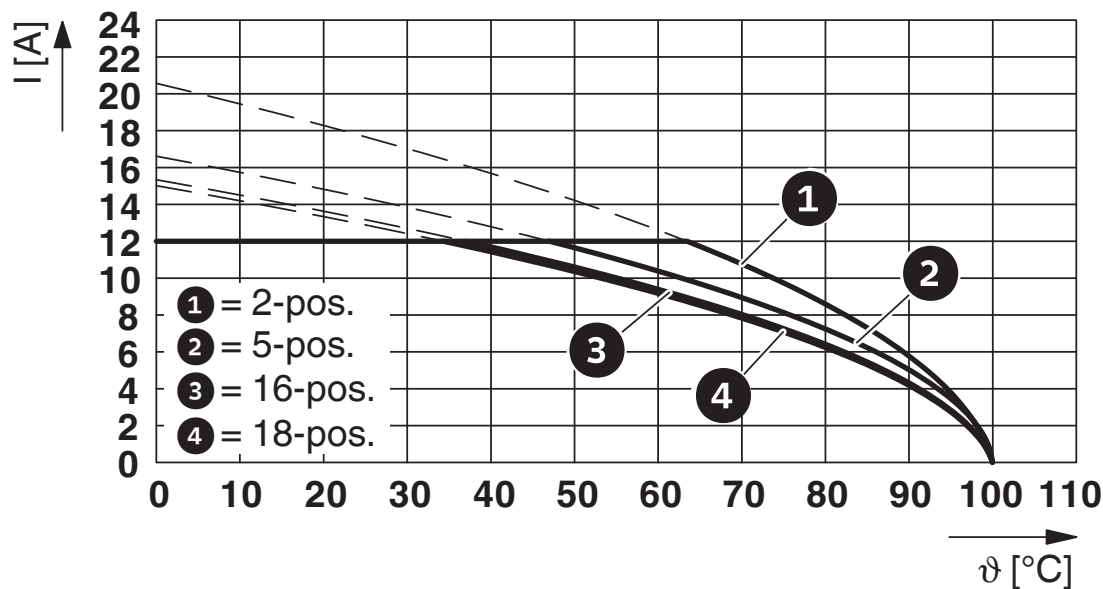

Type: FKCN 2,5/...-ST with MSTBVA 2,5/...-G



# FKCN 2,5/ 4-ST - PCB connector



1732768

<https://www.phoenixcontact.com/us/products/1732768>

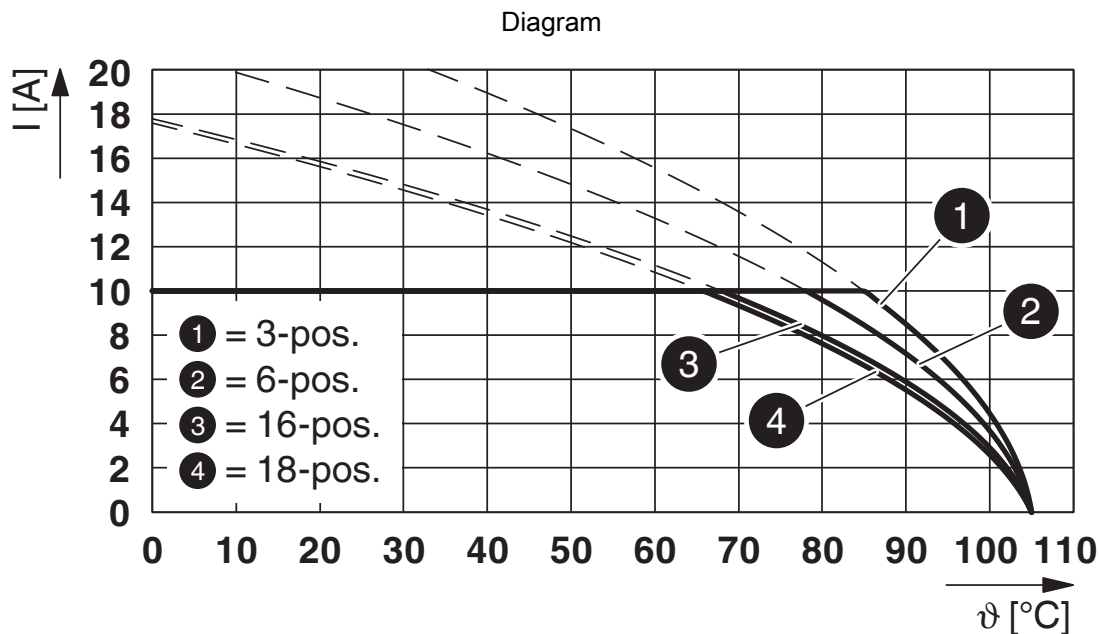

Type: FKCN 2,5/...-ST with MDSTB 2,5/...-G1

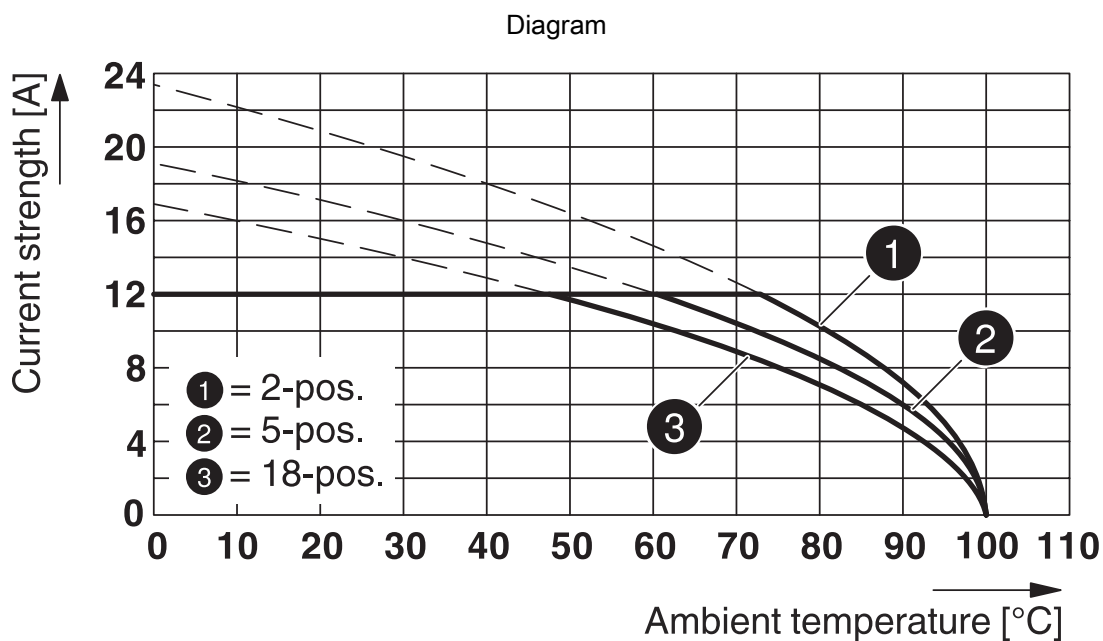

Type: FKCN 2,5/...-ST with CCDN 2,5/...-G1 P26 THR

# FKCN 2,5/ 4-ST - PCB connector



1732768

<https://www.phoenixcontact.com/us/products/1732768>

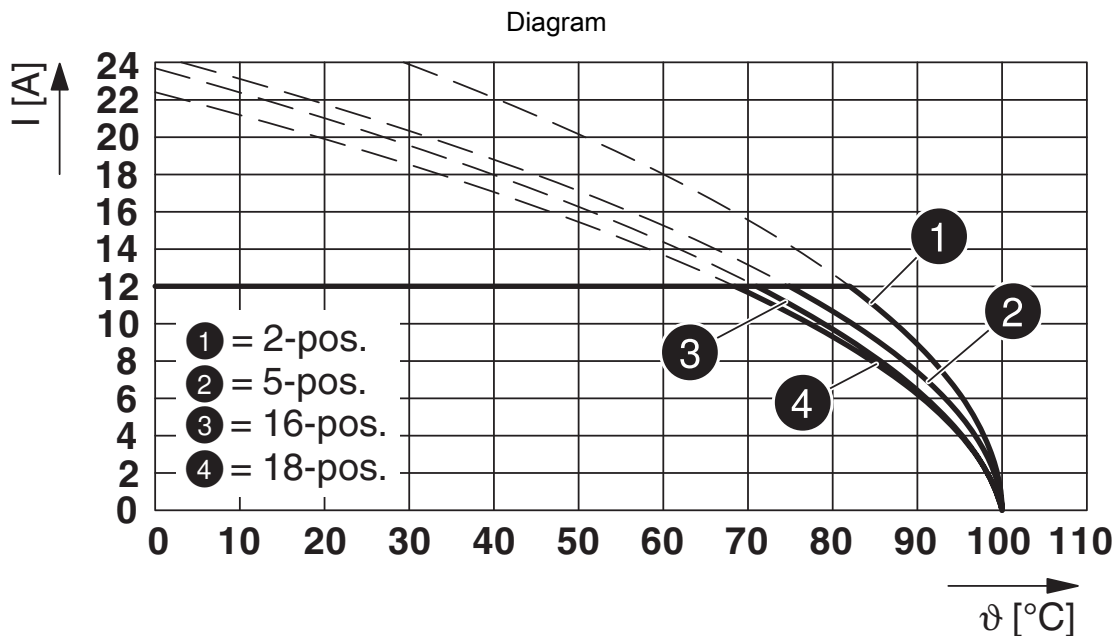

Type: FKCN 2,5/...-ST with MSTB 2,5/...-G

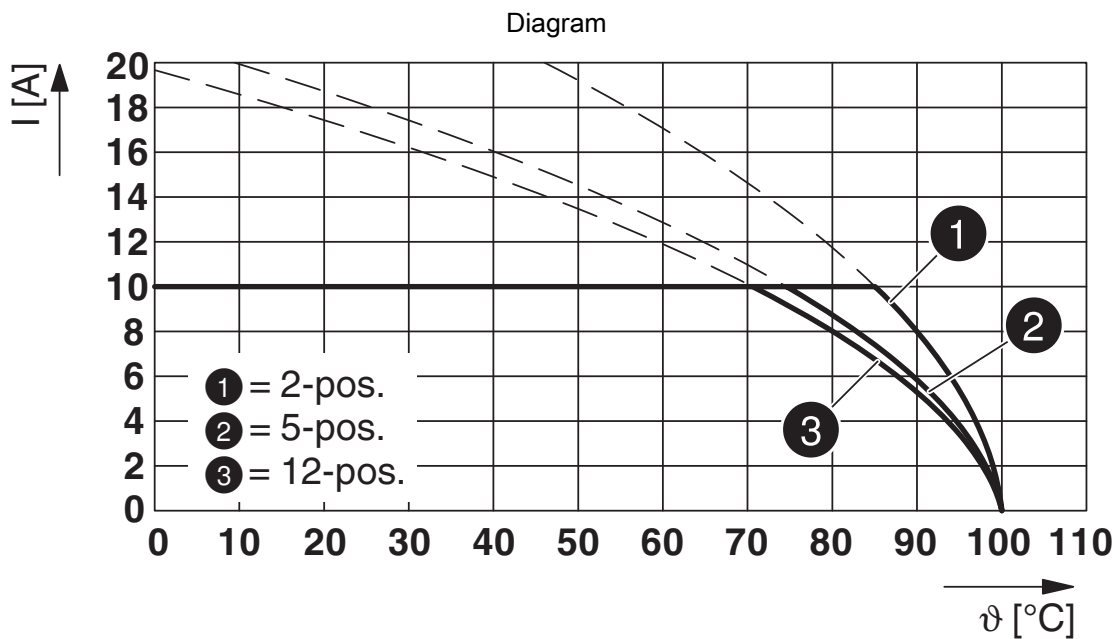

Type: FKCN 2,5/...-ST with MDSTBA 2,5/...-G

# FKCN 2,5/ 4-ST - PCB connector



1732768

<https://www.phoenixcontact.com/us/products/1732768>

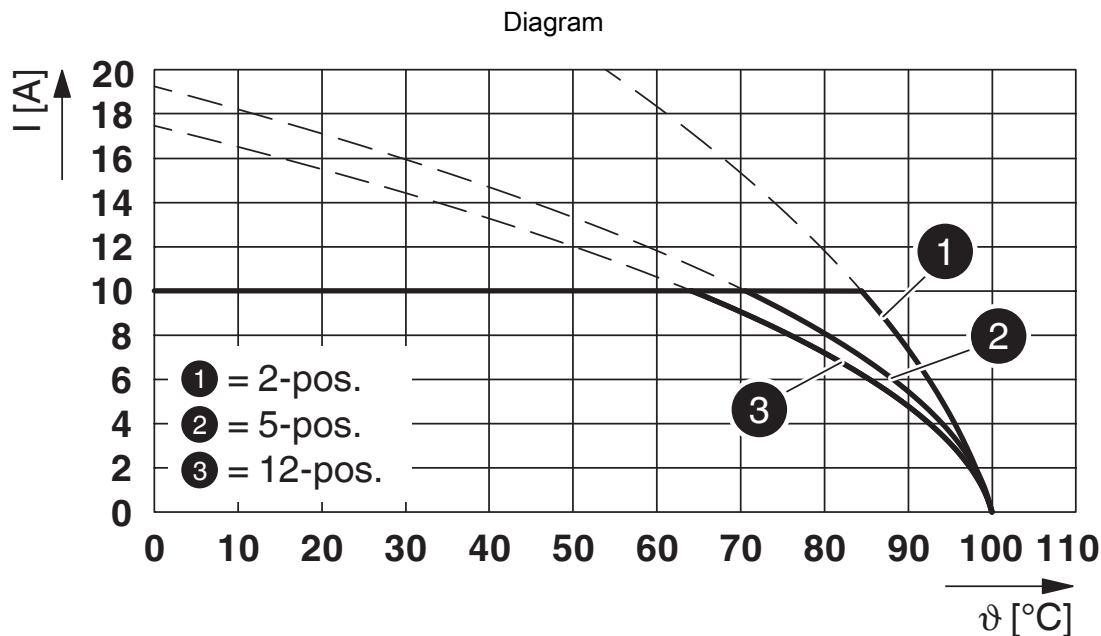

Type: FKCN 2,5/...-ST with MDSTBW 2,5/...-G

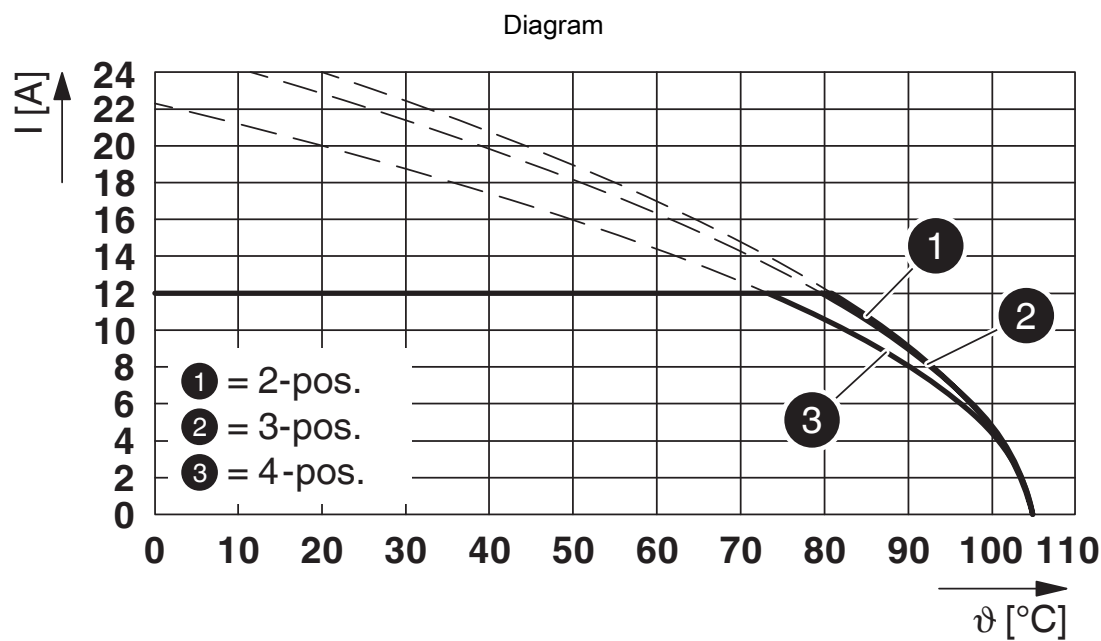

Type: FKCN 2,5/...-ST with MSTBO 2,5/...-G1R

# FKCN 2,5/ 4-ST - PCB connector



1732768

<https://www.phoenixcontact.com/us/products/1732768>

Diagram

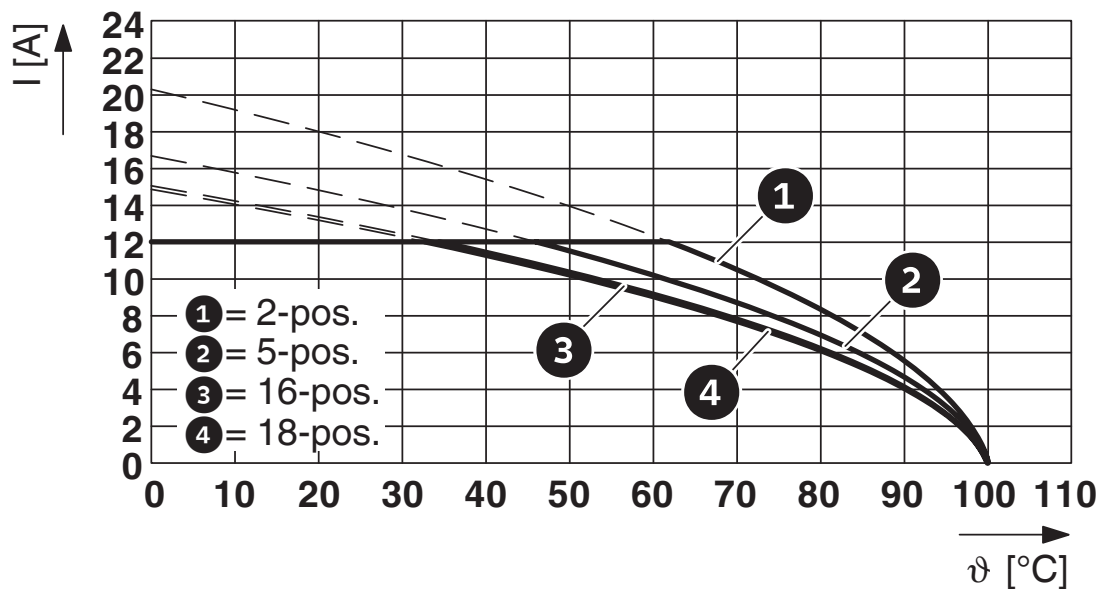

Type: FKCN 2,5/...-ST with MSTBV 2,5/...-G

Diagram

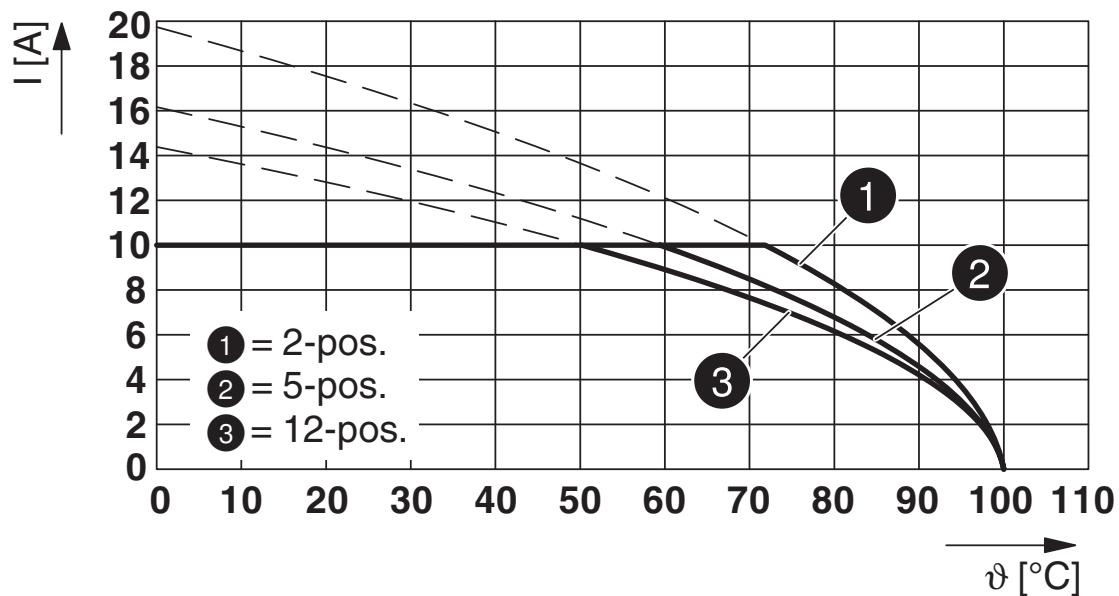

Type: FKCN 2,5/...-ST with MDSTBV 2,5/...-G

# FKCN 2,5/ 4-ST - PCB connector



1732768

<https://www.phoenixcontact.com/us/products/1732768>

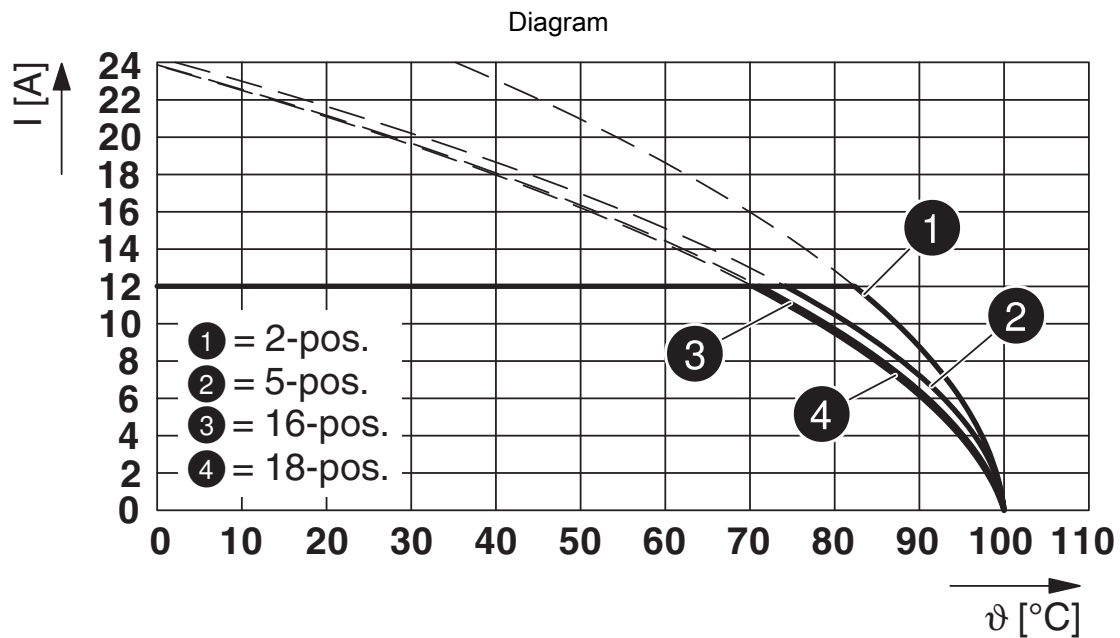

Type: FKCN 2,5/...-ST with SMSTBA 2,5/...-G

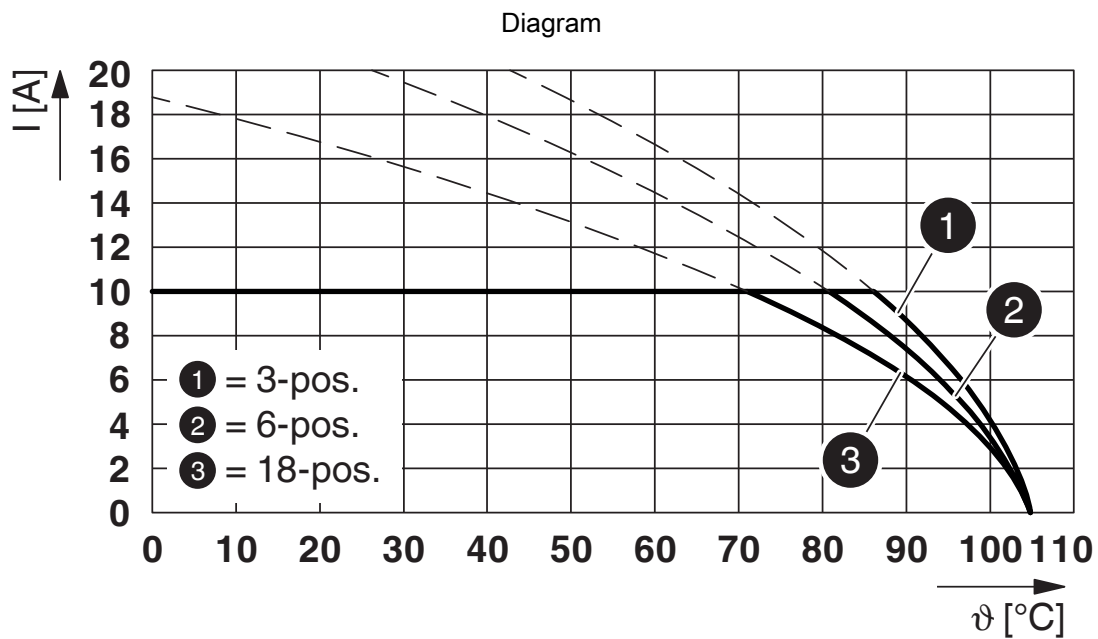

Type: FKCN 2,5/...-ST with MDSTBV 2,5/...-G1

# FKCN 2,5/ 4-ST - PCB connector



1732768

<https://www.phoenixcontact.com/us/products/1732768>

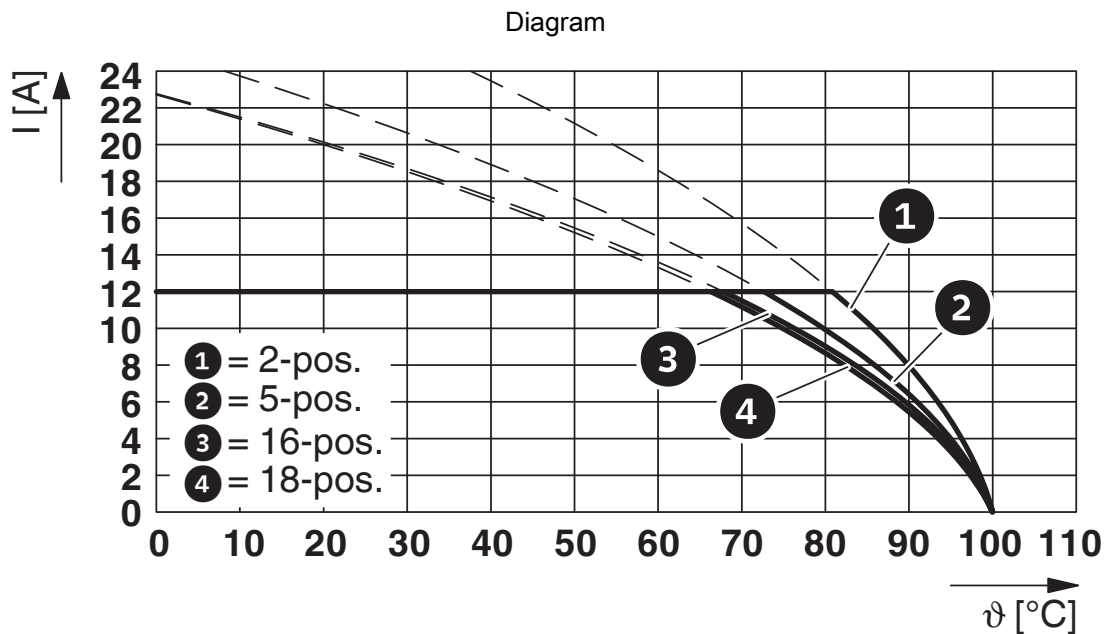

Type: FKCN 2,5/...-ST with MSTBW 2,5/...-G

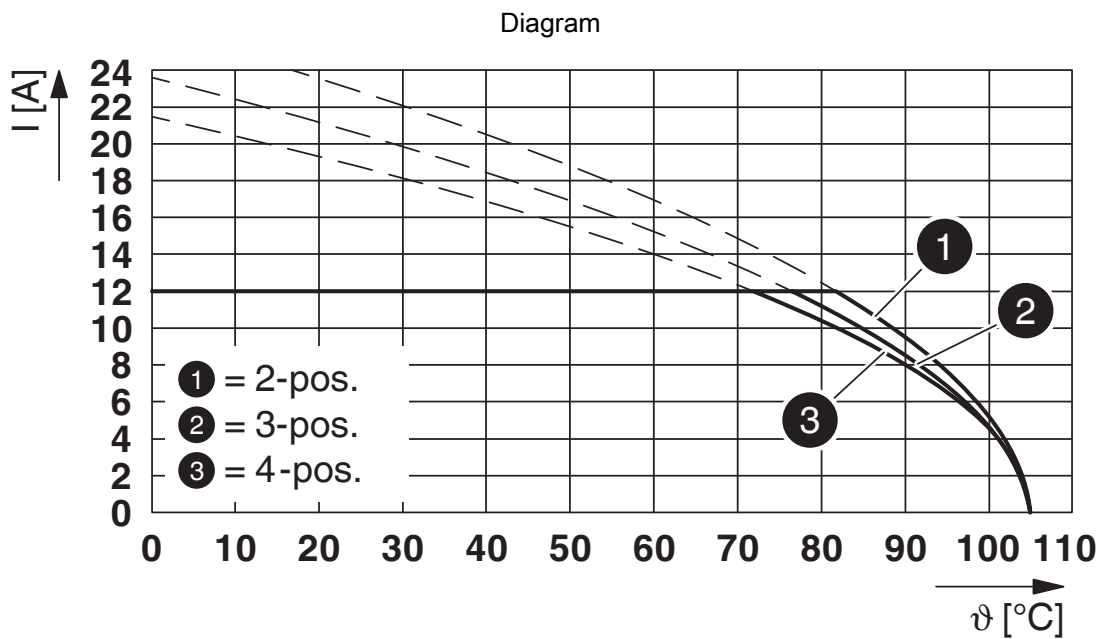

Type: FKCN 2,5/...-ST with MSTBO 2,5/...-G1L

# FKCN 2,5/ 4-ST - PCB connector



1732768

<https://www.phoenixcontact.com/us/products/1732768>

Diagram

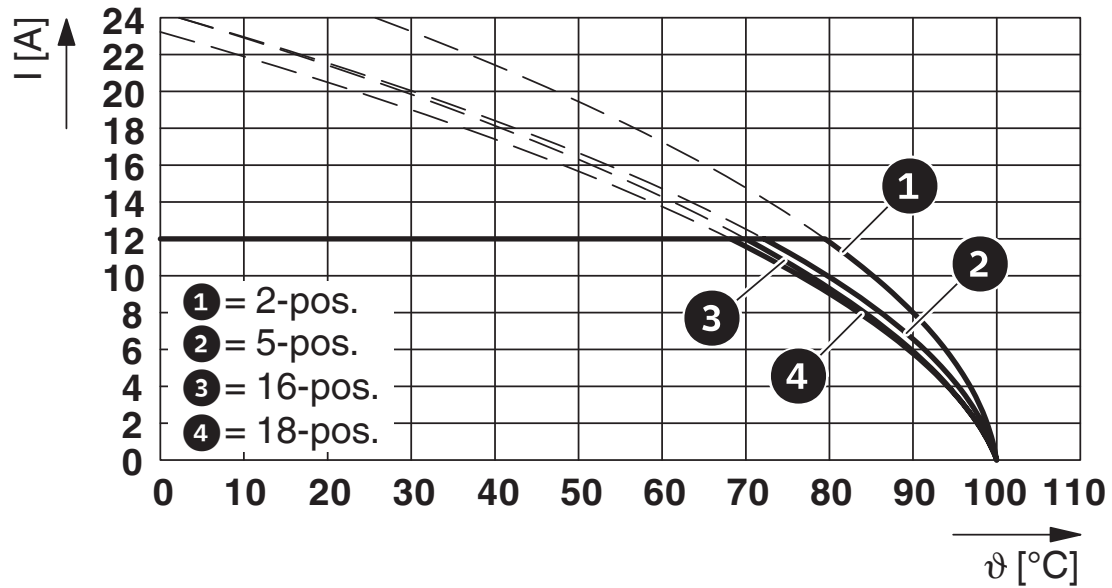

Type: FKCN 2,5/...-ST with MSTBA 2,5/...-G

# FKCN 2,5/ 4-ST - PCB connector



1732768

<https://www.phoenixcontact.com/us/products/1732768>

## Approvals

To download certificates, visit the product detail page: <https://www.phoenixcontact.com/us/products/1732768>

 <b>VDE Gutachten mit Fertigungsüberwachung</b> Approval ID: 40041908				
	Nominal voltage $U_N$	Nominal current $I_N$	Cross section AWG	Cross section $\text{mm}^2$
	400 V	12 A	-	0.2 - 2.5



# FKCN 2,5/ 4-ST - PCB connector



1732768

<https://www.phoenixcontact.com/us/products/1732768>

## Classifications

### ECLASS

ECLASS-11.0	27460202
ECLASS-12.0	27460202
ECLASS-13.0	27460202

### ETIM

ETIM 9.0	EC002638
----------	----------

### UNSPSC

UNSPSC 21.0	39121400
-------------	----------

# FKCN 2,5/ 4-ST - PCB connector



1732768

<https://www.phoenixcontact.com/us/products/1732768>

## Environmental product compliance

China RoHS	Environmentally friendly use period: unlimited = EFUP-e
	No hazardous substances above threshold values

# FKCN 2,5/ 4-ST - PCB connector

1732768

<https://www.phoenixcontact.com/us/products/1732768>

## Accessories

### CP-MSTB - Coding profile

1734634

<https://www.phoenixcontact.com/us/products/1734634>

Coding profile, is inserted into the slot on the plug or inverted header, red insulating material



---

### CRIMPFOX 6 - Crimping pliers

1212034

<https://www.phoenixcontact.com/us/products/1212034>

Crimping pliers, for ferrules without insulating collar according to DIN 46228 Part 1 and ferrules with insulating collar according to DIN 46228 Part 4, 0.25 mm<sup>2</sup> ... 6.0 mm<sup>2</sup>, lateral entry, trapezoidal crimp



# FKCN 2,5/ 4-ST - PCB connector

1732768

<https://www.phoenixcontact.com/us/products/1732768>



## AI 0,5 -10 WH - Ferrule

3201275

<https://www.phoenixcontact.com/us/products/3201275>



Ferrule, sleeve length: 10 mm, color: white

---

## AI 0,75-10 GY - Ferrule

3201288

<https://www.phoenixcontact.com/us/products/3201288>



Ferrule, sleeve length: 10 mm, color: gray

# FKCN 2,5/ 4-ST - PCB connector

1732768

<https://www.phoenixcontact.com/us/products/1732768>



## AI 1 -10 RD - Ferrule

3200182

<https://www.phoenixcontact.com/us/products/3200182>



Ferrule, sleeve length: 10 mm, color: red

---

## AI 1,5 -10 BK - Ferrule

3200195

<https://www.phoenixcontact.com/us/products/3200195>



Ferrule, sleeve length: 10 mm, color: black

# FKCN 2,5/ 4-ST - PCB connector

1732768

<https://www.phoenixcontact.com/us/products/1732768>

## A 0,5 -10 - Ferrule

3202494

<https://www.phoenixcontact.com/us/products/3202494>



Ferrule, color: silver

---

## A 0,75-10 - Ferrule

3200234

<https://www.phoenixcontact.com/us/products/3200234>



Ferrule, color: silver

# FKCN 2,5/ 4-ST - PCB connector

1732768

<https://www.phoenixcontact.com/us/products/1732768>

## A 1 -10 - Ferrule

3200250

<https://www.phoenixcontact.com/us/products/3200250>



Ferrule, color: silver

---

## A 1,5 -10 - Ferrule

3200276

<https://www.phoenixcontact.com/us/products/3200276>



Ferrule, color: silver

# FKCN 2,5/ 4-ST - PCB connector

1732768

<https://www.phoenixcontact.com/us/products/1732768>



## SZS 0,6X3,5 - Screwdriver

1205053

<https://www.phoenixcontact.com/us/products/1205053>



Actuation tool, for ST terminal blocks, insulated, also suitable for use as a bladed screwdriver, size: 0.6 x 3.5 x 100 mm, 2-component grip, with non-slip grip

## CCDN 2,5/ 4-G1 P26 THR - PCB header

1734290

<https://www.phoenixcontact.com/us/products/1734290>



PCB headers, nominal cross section: 2.5 mm<sup>2</sup>, color: black, nominal current: 12 A, rated voltage (III/2): 320 V, contact surface: Tin, contact connection type: Pin, number of potentials: 8, number of rows: 2, number of positions: 4, number of connections: 8, product range: CCDN 2,5/..-G1-THR, pitch: 5 mm, mounting: THR soldering, pin layout: Linear pinning, solder pin [P]: 2.6 mm, number of solder pins per potential: 1, plug-in system: COMBICON MSTB 2,5, Pin connector pattern alignment: Standard, locking: without, mounting: without, type of packaging: packed in cardboard



# FKCN 2,5/ 4-ST - PCB connector

1732768

<https://www.phoenixcontact.com/us/products/1732768>

## MSTBW 2,5/ 4-G - PCB header

1736098

<https://www.phoenixcontact.com/us/products/1736098>

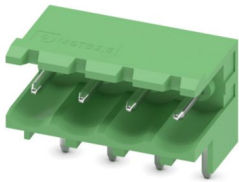

PCB headers, nominal cross section: 2.5 mm<sup>2</sup>, color: green, nominal current: 12 A, rated voltage (III/2): 320 V, contact surface: Tin, contact connection type: Pin, number of potentials: 4, number of rows: 1, number of positions: 4, number of connections: 4, product range: MSTBW 2,5/..-G, pitch: 5 mm, mounting: Wave soldering, pin layout: Linear pinning, solder pin [P]: 3.5 mm, number of solder pins per potential: 1, plug-in system: COMBICON MSTB 2,5, Pin connector pattern alignment: Standard, locking: without, mounting: without, type of packaging: packed in cardboard

## MSTBA 2,5/ 4-G - PCB header

1757491

<https://www.phoenixcontact.com/us/products/1757491>

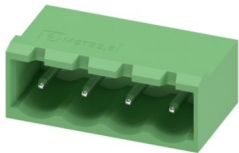

PCB headers, nominal cross section: 2.5 mm<sup>2</sup>, color: green, nominal current: 12 A, rated voltage (III/2): 320 V, contact surface: Tin, contact connection type: Pin, number of potentials: 4, number of rows: 1, number of positions: 4, number of connections: 4, product range: MSTBA 2,5/..-G, pitch: 5 mm, mounting: Wave soldering, pin layout: Linear pinning, solder pin [P]: 3.23 mm, number of solder pins per potential: 1, plug-in system: COMBICON MSTB 2,5, Pin connector pattern alignment: Standard, locking: without, mounting: without, type of packaging: packed in cardboard

# FKCN 2,5/ 4-ST - PCB connector

1732768

<https://www.phoenixcontact.com/us/products/1732768>

## SMSTBA 2,5/ 4-G - PCB header

1769829

<https://www.phoenixcontact.com/us/products/1769829>



PCB headers, nominal cross section: 2.5 mm<sup>2</sup>, color: green, nominal current: 12 A, rated voltage (III/2): 320 V, contact surface: Tin, contact connection type: Pin, number of potentials: 4, number of rows: 1, number of positions: 4, number of connections: 4, product range: SMSTBA 2,5/...-G, pitch: 5 mm, mounting: Wave soldering, pin layout: Linear pinning, solder pin [P]: 3.5 mm, number of solder pins per potential: 1, plug-in system: COMBICON MSTB 2,5, Pin connector pattern alignment: Standard, locking: without, mounting: without, type of packaging: packed in cardboard

## MDSTBV 2,5/ 4-G - PCB header

1845950

<https://www.phoenixcontact.com/us/products/1845950>

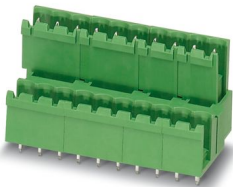

PCB headers, nominal cross section: 2.5 mm<sup>2</sup>, color: green, nominal current: 10 A, rated voltage (III/2): 320 V, contact surface: Tin, contact connection type: Pin, number of potentials: 8, number of rows: 2, number of positions: 4, number of connections: 8, product range: MDSTBV 2,5/...-G, pitch: 5 mm, mounting: Wave soldering, pin layout: Linear pinning, solder pin [P]: 3.9 mm, number of solder pins per potential: 1, plug-in system: COMBICON MSTB 2,5, Pin connector pattern alignment: Standard, locking: without, mounting: without, type of packaging: packed in cardboard, Can be aligned! Mounting flange: Item No. 1836477, 1836480. In combination with MVSTB or FKCV plug components, both an MVSTBW (or FKCVW) and an MVSTBR plug (or FKCVR) must be used. Combination with TMSTBP plug components is not possible!

# FKCN 2,5/ 4-ST - PCB connector

1732768

<https://www.phoenixcontact.com/us/products/1732768>

## MDSTBA 2,5/ 4-G - PCB header

1846535

<https://www.phoenixcontact.com/us/products/1846535>

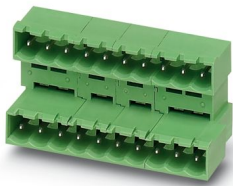

PCB headers, nominal cross section: 2.5 mm<sup>2</sup>, color: green, nominal current: 10 A, rated voltage (III/2): 320 V, contact surface: Tin, contact connection type: Pin, number of potentials: 8, number of rows: 2, number of positions: 4, number of connections: 8, product range: MDSTBA 2,5/...-G, pitch: 5 mm, mounting: Wave soldering, pin layout: Linear pinning, solder pin [P]: 3.23 mm, number of solder pins per potential: 1, plug-in system: COMBICON MSTB 2,5, Pin connector pattern alignment: Standard, locking: without, mounting: without, type of packaging: packed in cardboard, The article can be aligned to create different nos. of positions! In combination with MVSTB or FKCV plug components, both an MVSTBW (or FKCVW) and an MVSTBR plug (or FKCVR) must be used. Combination with TMSTBP plug components is not possible!

## MSTBO 2,5/ 4-G1L - PCB header

1861060

<https://www.phoenixcontact.com/us/products/1861060>



PCB headers, nominal cross section: 2.5 mm<sup>2</sup>, color: green, nominal current: 12 A, rated voltage (III/2): 320 V, contact surface: Tin, contact connection type: Pin, number of potentials: 4, number of rows: 1, number of positions: 4, number of connections: 4, product range: MSTBO 2,5/...-G1L, pitch: 5 mm, mounting: Wave soldering, pin layout: Linear pinning, solder pin [P]: 3.5 mm, number of solder pins per potential: 1, plug-in system: COMBICON MSTB 2,5, locking: without, type of packaging: packed in cardboard, Product with pin output on left side

# FKCN 2,5/ 4-ST - PCB connector

1732768

<https://www.phoenixcontact.com/us/products/1732768>



## MSTBO 2,5/ 4-G1R - PCB header

1861073

<https://www.phoenixcontact.com/us/products/1861073>



PCB headers, nominal cross section: 2.5 mm<sup>2</sup>, color: green, nominal current: 12 A, rated voltage (III/2): 320 V, contact surface: Tin, contact connection type: Pin, number of potentials: 4, number of rows: 1, number of positions: 4, number of connections: 4, product range: MSTBO 2,5/..-G1R, pitch: 5 mm, connection method: pluggable, mounting: Wave soldering, pin layout: Linear pinning, solder pin [P]: 3.5 mm, number of solder pins per potential: 1, plug-in system: COMBICON MSTB 2,5, locking: without, type of packaging: packed in cardboard, Product with pin output on right side

## CCA 2,5/ 4-G P20 THR - PCB header

1836366

<https://www.phoenixcontact.com/us/products/1836366>



PCB headers, nominal cross section: 2.5 mm<sup>2</sup>, color: black, nominal current: 12 A, rated voltage (III/2): 320 V, contact surface: Tin, contact connection type: Pin, number of potentials: 4, number of rows: 1, number of positions: 4, number of connections: 4, product range: CCA 2,5/..-G, pitch: 5 mm, mounting: THR soldering, pin layout: Linear pinning, solder pin [P]: 2 mm, number of solder pins per potential: 1, plug-in system: COMBICON MSTB 2,5, Pin connector pattern alignment: Standard, locking: without, mounting: without, type of packaging: packed in cardboard, For user information and design recommendations for through-hole reflow technology, go to: Downloads

# FKCN 2,5/ 4-ST - PCB connector

1732768

<https://www.phoenixcontact.com/us/products/1732768>

## CCA 2,5/ 4-G P20THRR56 - PCB header

1836599

<https://www.phoenixcontact.com/us/products/1836599>



PCB headers, nominal cross section: 2.5 mm<sup>2</sup>, color: black, nominal current: 12 A, rated voltage (III/2): 320 V, contact surface: Tin, contact connection type: Pin, number of potentials: 4, number of rows: 1, number of positions: 4, number of connections: 4, product range: CCA 2,5/..-G, pitch: 5 mm, mounting: THR soldering, pin layout: Linear pinning, solder pin [P]: 2 mm, number of solder pins per potential: 1, plug-in system: COMBICON MSTB 2,5, Pin connector pattern alignment: Standard, locking: without, mounting: without, type of packaging: 56 mm wide tape, For user information and design recommendations for through-hole reflow technology, go to: Downloads

## CCVA 2,5/ 4-G P20 THR - PCB header

1837048

<https://www.phoenixcontact.com/us/products/1837048>



PCB headers, nominal cross section: 2.5 mm<sup>2</sup>, color: black, nominal current: 12 A, rated voltage (III/2): 320 V, contact surface: Tin, contact connection type: Pin, number of potentials: 4, number of rows: 1, number of positions: 4, number of connections: 4, product range: CCVA 2,5/..-G, pitch: 5 mm, mounting: THR soldering, pin layout: Linear pinning, solder pin [P]: 2 mm, number of solder pins per potential: 1, plug-in system: COMBICON MSTB 2,5, Pin connector pattern alignment: Standard, locking: without, mounting: without, type of packaging: packed in cardboard, For user information and design recommendations for through-hole reflow technology, go to: Downloads

# FKCN 2,5/ 4-ST - PCB connector

1732768

<https://www.phoenixcontact.com/us/products/1732768>



## CCVA 2,5/ 4-G P20THRR56 - PCB header

1837271

<https://www.phoenixcontact.com/us/products/1837271>



PCB headers, nominal cross section: 2.5 mm<sup>2</sup>, color: black, nominal current: 12 A, rated voltage (III/2): 320 V, contact surface: Tin, contact connection type: Pin, number of potentials: 4, number of rows: 1, number of positions: 4, number of connections: 4, product range: CCVA 2,5/..-G, pitch: 5 mm, mounting: THR soldering, pin layout: Linear pinning, solder pin [P]: 2 mm, number of solder pins per potential: 1, plug-in system: COMBICON MSTB 2,5, Pin connector pattern alignment: Standard, locking: without, mounting: without, type of packaging: 56 mm wide tape, For user information and design recommendations for through-hole reflow technology, go to: Downloads

## MSTBO 2,5/ 4-G1L THRR44 BK - PCB header

2697194

<https://www.phoenixcontact.com/us/products/2697194>



PCB headers, nominal cross section: 2.5 mm<sup>2</sup>, color: black, nominal current: 16 A, rated voltage (III/2): 320 V, contact surface: Tin, contact connection type: Pin, number of rows: 1, number of positions: 4, product range: MSTBO 2,5/..-G1L-THR, pitch: 5 mm, mounting: THR soldering, pin layout: Linear pinning, solder pin [P]: 2.5 mm, number of solder pins per potential: 1, plug-in system: COMBICON MSTB 2,5, locking: without, type of packaging: 44 mm wide tape, Product with pin output on left side

# FKCN 2,5/ 4-ST - PCB connector

1732768

<https://www.phoenixcontact.com/us/products/1732768>



## MSTBO 2,5/ 4-G1R THRR44 BK - PCB header

2697204

<https://www.phoenixcontact.com/us/products/2697204>



PCB headers, nominal cross section: 2.5 mm<sup>2</sup>, color: black, nominal current: 16 A, rated voltage (III/2): 320 V, contact surface: Tin, contact connection type: Pin, number of rows: 1, number of positions: 4, product range: MSTBO 2,5/..-G1R-THR, pitch: 5 mm, mounting: THR soldering, pin layout: Linear pinning, solder pin [P]: 2.5 mm, number of solder pins per potential: 1, plug-in system: COMBICON MSTB 2,5, locking: without, type of packaging: 44 mm wide tape, Product with pin output on right side

## MSTBO 2,5/ 4-G1L KMGY - PCB header

2907774

<https://www.phoenixcontact.com/us/products/2907774>



PCB headers, nominal cross section: 2.5 mm<sup>2</sup>, color: light grey, nominal current: 12 A, rated voltage (III/2): 320 V, contact surface: Tin, contact connection type: Pin, number of potentials: 4, number of rows: 1, number of positions: 4, number of connections: 4, product range: MSTBO 2,5/..-G1L, pitch: 5 mm, mounting: Wave soldering, pin layout: Linear pinning, solder pin [P]: 3.5 mm, number of solder pins per potential: 1, plug-in system: COMBICON MSTB 2,5, locking: without, type of packaging: packed in cardboard, Product with pin output on left side

# FKCN 2,5/ 4-ST - PCB connector

1732768

<https://www.phoenixcontact.com/us/products/1732768>



## MSTBO 2,5/ 4-G1R KMGY - PCB header

2907787

<https://www.phoenixcontact.com/us/products/2907787>



PCB headers, nominal cross section: 2.5 mm<sup>2</sup>, color: light grey, nominal current: 12 A, rated voltage (III/2): 320 V, contact surface: Tin, contact connection type: Pin, number of potentials: 4, number of rows: 1, number of positions: 4, number of connections: 4, product range: MSTBO 2,5/..-G1R, pitch: 5 mm, connection method: pluggable, mounting: Wave soldering, pin layout: Linear pinning, solder pin [P]: 3.5 mm, number of solder pins per potential: 1, plug-in system: COMBICON MSTB 2,5, locking: without, type of packaging: packed in cardboard, Product with pin output on right side

---

Phoenix Contact 2024 © - all rights reserved

<https://www.phoenixcontact.com>

Phoenix Contact USA  
586 Fulling Mill Road  
Middletown, PA 17057, United States  
(+717) 944-1300  
[info@phoenixcon.com](mailto:info@phoenixcon.com)