

SHO-102

Aliases (UDLSHO01020000, SHO102)

KEMET, SHO, DC Line Filters, Common Mode, 600 nH

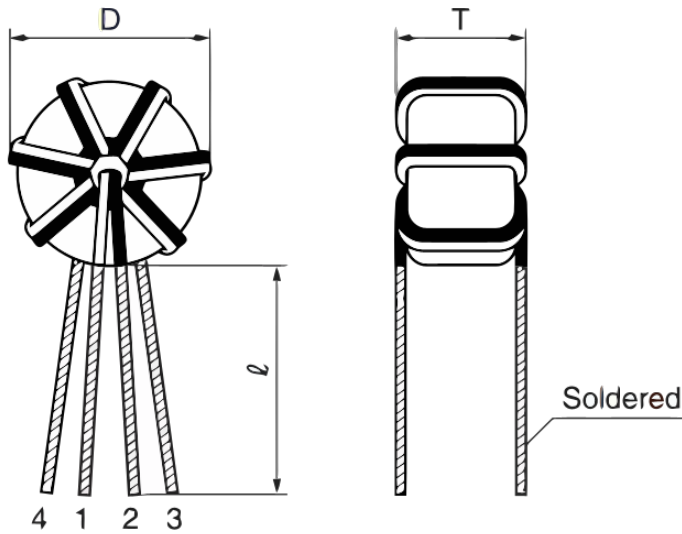

Click [here](#) for the 3D model.

General Information

Series	SHO
Style	Through-Hole
RoHS	Yes

Specifications

Voltage DC	50 VDC
Inductance	0.6 uH
Temperature Range	-25/+70°C
DC Resistance	10 mOhms

Dimensions

L	11mm MAX
T	7.5mm MAX
H	11mm MAX
LL	10mm +/-3mm

Packaging Specifications

Packaging	Bulk, Box
Packaging Quantity	6000
Component Weight	1.05 g

Statements of suitability for certain applications are based on our knowledge of typical operating conditions for such applications, but are not intended to constitute - and we specifically disclaim - any warranty concerning suitability for a specific customer application or use. This Information is intended for use only by customers who have the requisite experience and capability to determine the correct products for their application. Any technical advice inferred from this Information or otherwise provided by us with reference to the use of our products is given gratis, and we assume no obligation or liability for the advice given or results obtained.