



STD10NM65N - STF10NM65N STP10NM65N - STU10NM65N

N-channel 650 V, 0.43 Ω , 9 A MDmesh™ II Power MOSFET
TO-220, TO-220FP, IPAK, DPAK

Features

Type	V _{DSS} (@T _{jmax})	R _{DS(on)} max	I _D
STD10NM65N	710 V	< 0.48 Ω	9 A
STF10NM65N	710 V	< 0.48 Ω	9 A ⁽¹⁾
STP10NM65N	710 V	< 0.48 Ω	9 A
STU10NM65N	710 V	< 0.48 Ω	9 A

1. Limited only by maximum temperature allowed

- 100% avalanche tested
- Low input capacitance and gate charge
- Low gate input resistance

Application

- Switching applications

Description

This series of devices implements the second generation of MDmesh™ Technology. This revolutionary Power MOSFET associates a new vertical structure to the Company's strip layout to yield one of the world's lowest on-resistance and gate charge. It is therefore suitable for the most demanding high efficiency converters.

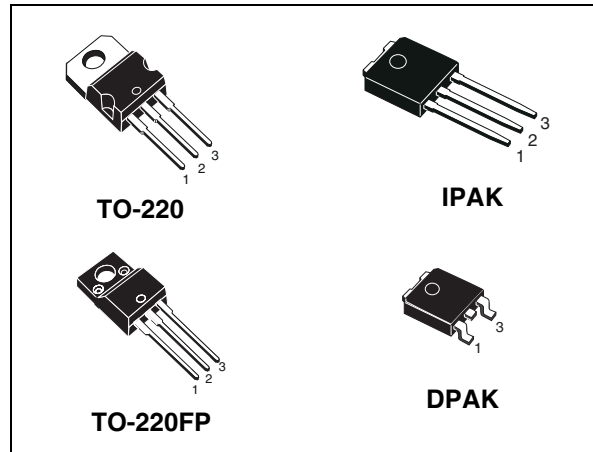

Figure 1. Internal schematic diagram

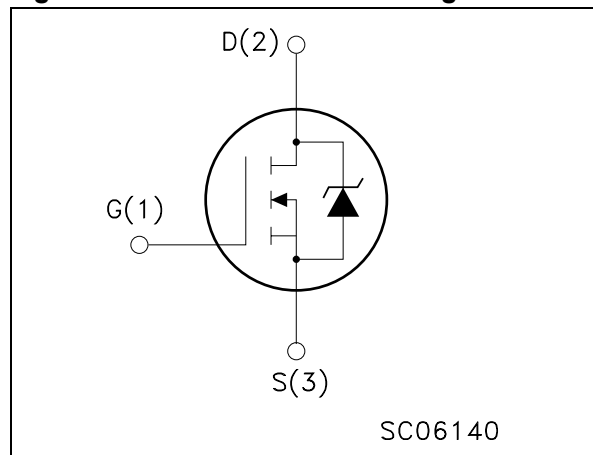

Table 1. Device summary

Order codes	Marking	Package	Packaging
STD10NM65N	10NM65N	DPAK	Tape & reel
STF10NM65N	10NM65N	TO-220FP	Tube
STP10NM65N	10NM65N	TO-220	Tube
STU10NM65N	10NM65N	IPAK	Tube

Contents

1	Electrical ratings	3
2	Electrical characteristics	4
2.1	Electrical characteristics (curves)	7
3	Test circuit	10
4	Package mechanical data	11
5	Package mechanical data	16
6	Revision history	17

1 Electrical ratings

Table 2. Absolute maximum ratings

Symbol	Parameter	Value		Unit
		TO-220/IPAK DPAK	TO-220FP	
V_{DS}	Drain-source voltage ($V_{GS} = 0$)	650		V
V_{GS}	Gate-source voltage	± 25		V
I_D	Drain current (continuous) at $T_C = 25\text{ }^\circ\text{C}$	9	$9^{(1)}$	A
I_D	Drain current (continuous) at $T_C = 100\text{ }^\circ\text{C}$	5.7	$5.7^{(1)}$	A
$I_{DM}^{(2)}$	Drain current (pulsed)	36	$36^{(1)}$	A
P_{TOT}	Total dissipation at $T_C = 25\text{ }^\circ\text{C}$	90	25	W
$dv/dt^{(3)}$	Peak diode recovery voltage slope	15		V/ns
V_{ISO}	Insulation withstand voltage (RMS) from all three leads to external heat sink ($t=1\text{ s}$; $T_C = 25\text{ }^\circ\text{C}$)	--	2500	V
T_{stg}	Storage temperature	-55 to 150		$^\circ\text{C}$
T_j	Max. operating junction temperature	150		$^\circ\text{C}$

1. Limited only by maximum temperature allowed
2. Pulse width limited by safe operating area
3. $I_{SD} \leq 9\text{ A}$, $di/dt \leq 400\text{ A}/\mu\text{s}$, $V_{DD} = 80\% V_{(BR)DSS}$

Table 3. Thermal data

Symbol	Parameter	TO-220	IPAK	DPAK	TO-220FP	Unit
$R_{thj-case}$	Thermal resistance junction-case max	1.38			5	$^\circ\text{C}/\text{W}$
$R_{thj-pcb}$	Thermal resistance junction-pcb max	--	--	50	--	$^\circ\text{C}/\text{W}$
$R_{thj-amb}$	Thermal resistance junction-amb max	62.5	100	--	62.5	$^\circ\text{C}/\text{W}$
T_l	Maximum lead temperature for soldering purpose	300				$^\circ\text{C}$

Table 4. Avalanche characteristics

Symbol	Parameter	Max value	Unit
I_{AS}	Avalanche current, repetitive or not-repetitive (pulse width limited by $T_j\text{ max}$)	2.5	A
E_{AS}	Single pulse avalanche energy (starting $T_j = 25\text{ }^\circ\text{C}$, $I_D = I_{AS}$, $V_{DD} = 50\text{ V}$)	200	mJ

2 Electrical characteristics

($T_{CASE}=25\text{ °C}$ unless otherwise specified)

Table 5. On/off states

Symbol	Parameter	Test conditions	Min.	Typ.	Max.	Unit
$V_{(BR)DSS}$	Drain-source breakdown voltage	$I_D = 1\text{ mA}$, $V_{GS} = 0$	650			V
$dv/dt^{(1)}$	Drain source voltage slope	$V_{DD} = 520\text{ V}$, $I_D = 9\text{ A}$, $V_{GS} = 10\text{ V}$		25		V/ns
I_{DSS}	Zero gate voltage drain current ($V_{GS} = 0$)	$V_{DS} = \text{max rating}$ $V_{DS} = \text{max rating}$, @125 °C			1 100	μA μA
I_{GSS}	Gate-body leakage current ($V_{DS} = 0$)	$V_{GS} = \pm 20\text{ V}$			± 100	nA
$V_{GS(th)}$	Gate threshold voltage	$V_{DS} = V_{GS}$, $I_D = 250\text{ }\mu\text{A}$	2	3	4	V
$R_{DS(on)}$	Static drain-source on resistance	$V_{GS} = 10\text{ V}$, $I_D = 4.5\text{ A}$		0.43	0.48	Ω

1. Characteristics value at turn off on inductive load

Table 6. Dynamic

Symbol	Parameter	Test conditions	Min.	Typ.	Max.	Unit
$g_{fs}^{(1)}$	Forward transconductance	$V_{DS} = 15\text{ V}$, $I_D = 4.5\text{ A}$		7.5		S
C_{iss} C_{oss} C_{rss}	Input capacitance Output capacitance Reverse transfer capacitance	$V_{DS} = 50\text{ V}$, $f = 1\text{ MHz}$, $V_{GS} = 0$		850 53 4		pF pF pF
$C_{oss\text{ eq.}}^{(2)}$	Equivalent output capacitance	$V_{GS} = 0$, $V_{DS} = 0\text{ to }520\text{ V}$		90		pF
Q_g Q_{gs} Q_{gd}	Total gate charge Gate-source charge Gate-drain charge	$V_{DD} = 520\text{ V}$, $I_D = 9\text{ A}$, $V_{GS} = 10\text{ V}$, (see Figure 19)		25 14 4		nC nC nC

1. Pulsed: pulse duration = 300 μs , duty cycle 1.5%

2. $C_{oss\text{ eq.}}$ is defined as a constant equivalent capacitance giving the same charging time as C_{oss} when V_{DS} increases from 0 to 80% V_{DSS}

Table 7. Switching times

Symbol	Parameter	Test conditions	Min	Typ	Max	Unit
$t_{d(on)}$	Turn-on delay time	$V_{DD} = 325\text{ V}$, $I_D = 4.5\text{ A}$ $R_G = 4.7\ \Omega$, $V_{GS} = 10\text{ V}$ <i>(see Figure 18)</i>		12		ns
t_r	Rise time			8		ns
$t_{d(off)}$	Turn-off delay time				50	ns
t_f	Fall time				20	ns

Table 8. Source drain diode

Symbol	Parameter	Test conditions	Min	Typ	Max	Unit
I_{SD}	Source-drain current				9	A
$I_{SDM}^{(1)}$	Source-drain current (pulsed)				36	A
$V_{SD}^{(2)}$	Forward on voltage	$I_{SD} = 9\text{ A}$, $V_{GS} = 0$			1.3	V
t_{rr}	Reverse recovery time	$I_{SD} = 9\text{ A}$, $di/dt = 100\text{ A}/\mu\text{s}$ $V_{DD} = 100\text{ V}$ <i>(see Figure 20)</i>		330		ns
Q_{rr}	Reverse recovery charge				3	μC
I_{RRM}	Reverse recovery current				19	A
t_{rr}	Reverse recovery time	$I_{SD} = 9\text{ A}$, $di/dt = 100\text{ A}/\mu\text{s}$ $V_{DD} = 100\text{ V}$, $T_j = 150\text{ }^\circ\text{C}$ <i>(see Figure 20)</i>		430		ns
Q_{rr}	Reverse recovery charge				4	μC
I_{RRM}	Reverse recovery current				19	A

1. Pulse width limited by safe operating area
2. Pulsed: pulse duration = 300 μs , duty cycle 1.5%

2.1 Electrical characteristics (curves)

Figure 2. Safe operating area for TO-220

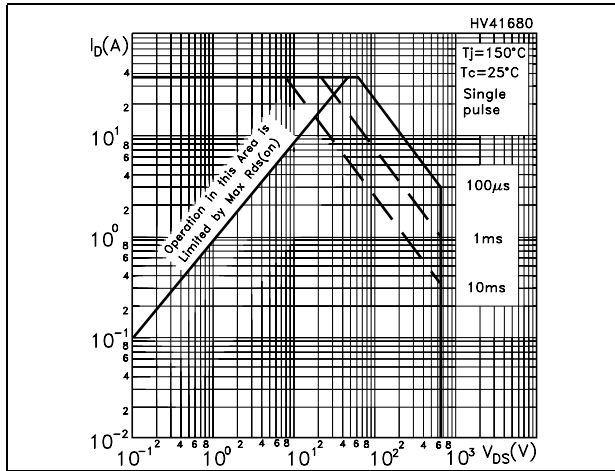

Figure 3. Thermal impedance for TO-220

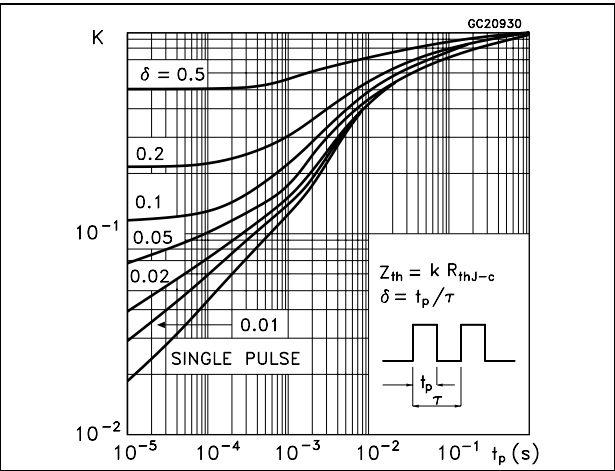

Figure 4. Safe operating area for TO-220FP

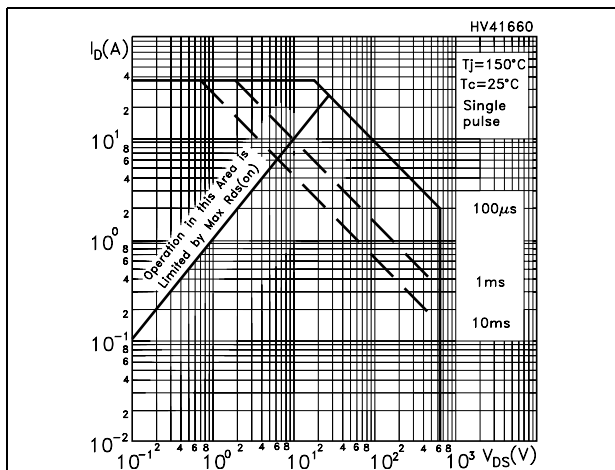

Figure 5. Thermal impedance for TO-220FP

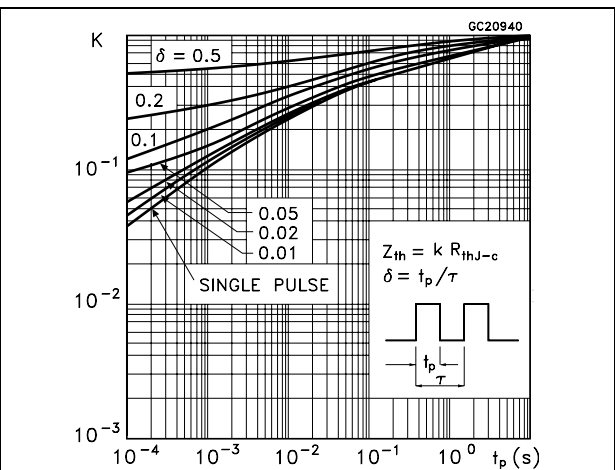

Figure 6. Safe operating area for DPAK/IPAK

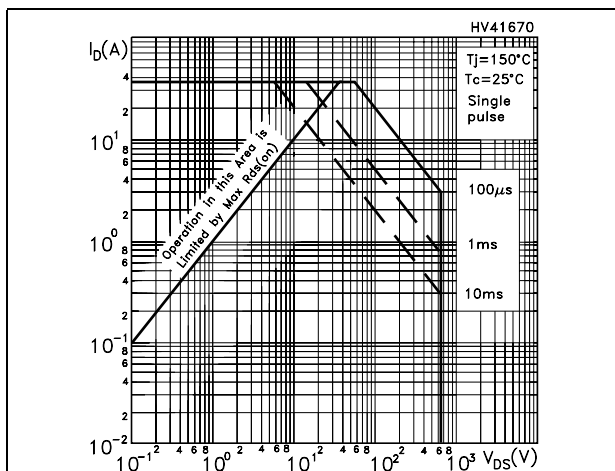

Figure 7. Thermal impedance for DPAK/IPAK

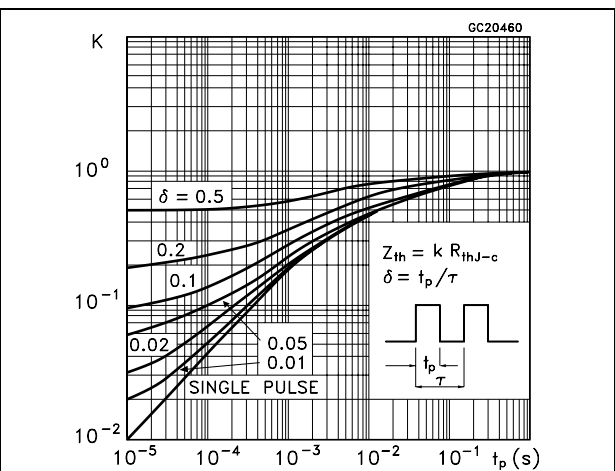

Figure 8. Output characteristics

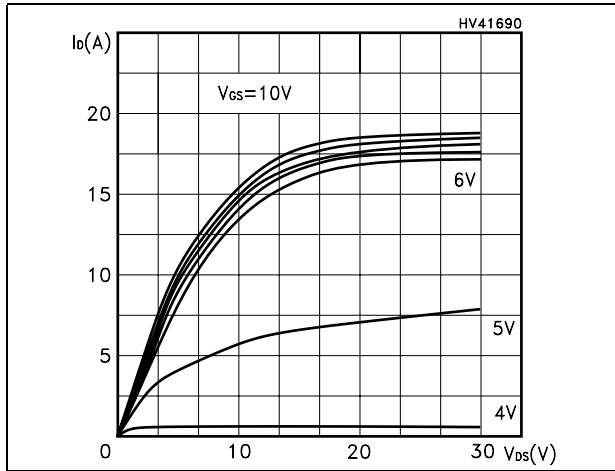

Figure 9. Transfer characteristics

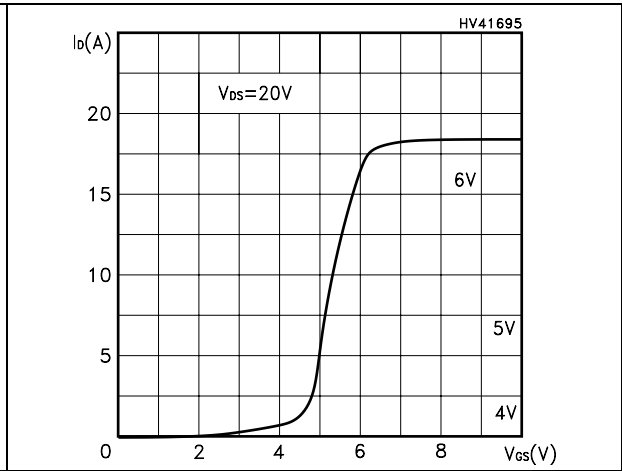

Figure 10. Transconductance

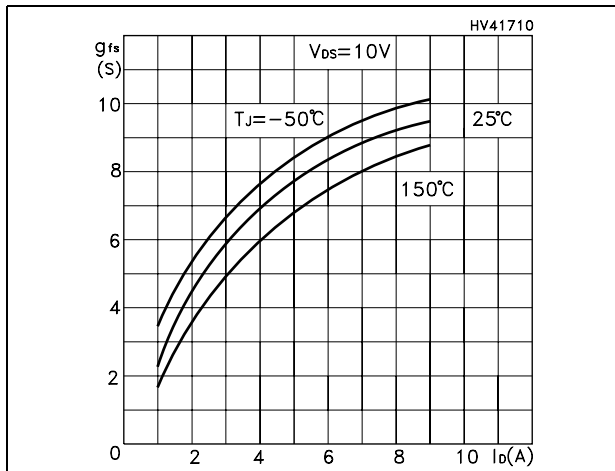

Figure 11. Static drain-source on resistance

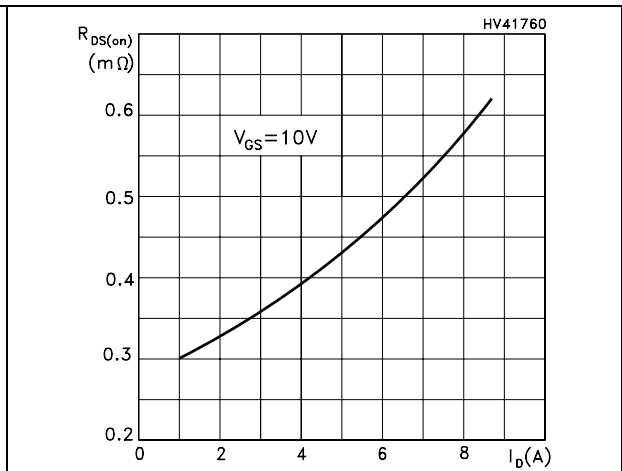

Figure 12. Gate charge vs gate source voltage Figure 13. Capacitance variations

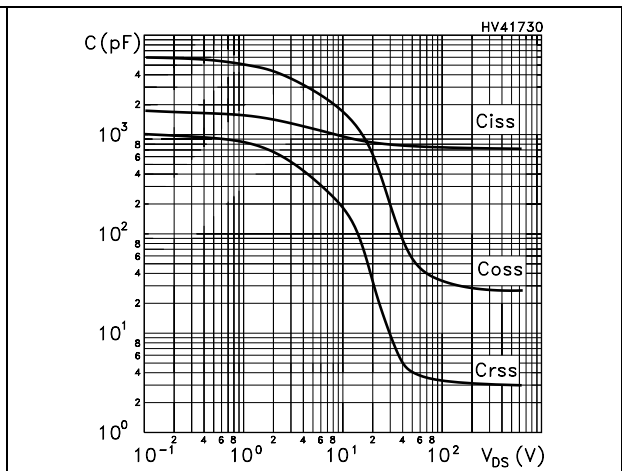
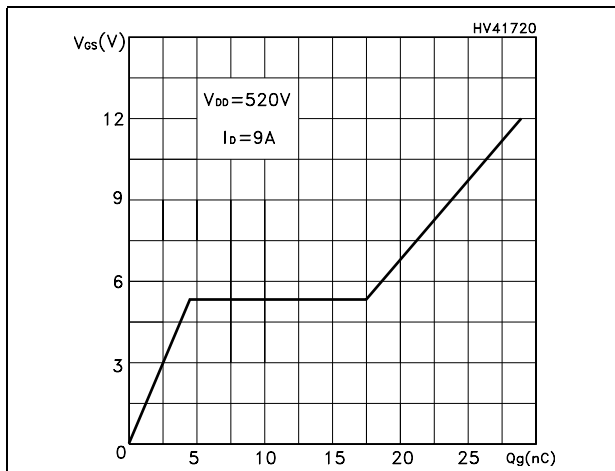

Figure 14. Normalized gate threshold voltage vs temperature

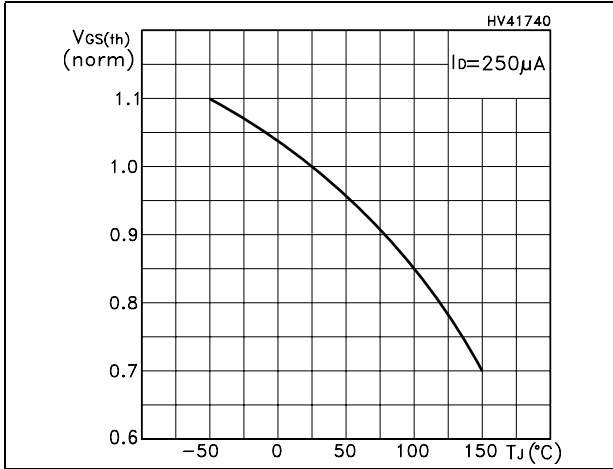

Figure 15. Normalized on resistance vs temperature

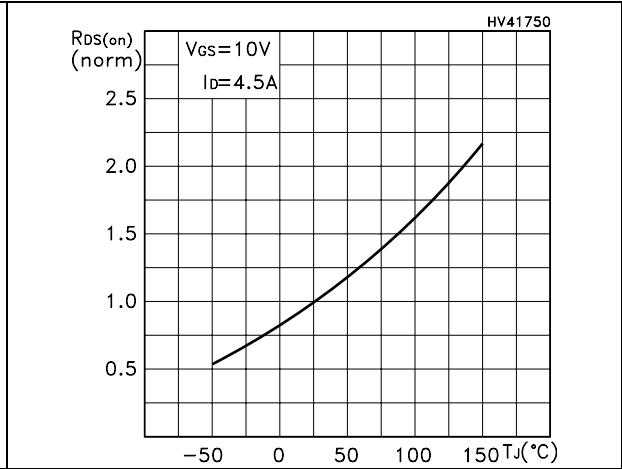

Figure 16. Source-drain diode forward characteristics

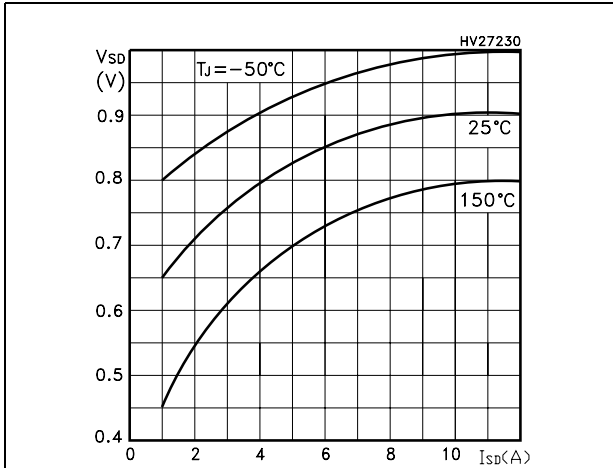
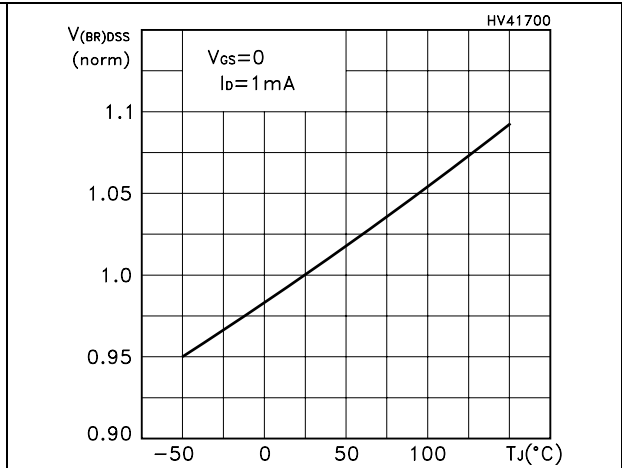

Figure 17. Normalized BV_{DSS} vs temperature



3 Test circuit

Figure 18. Switching times test circuit for resistive load

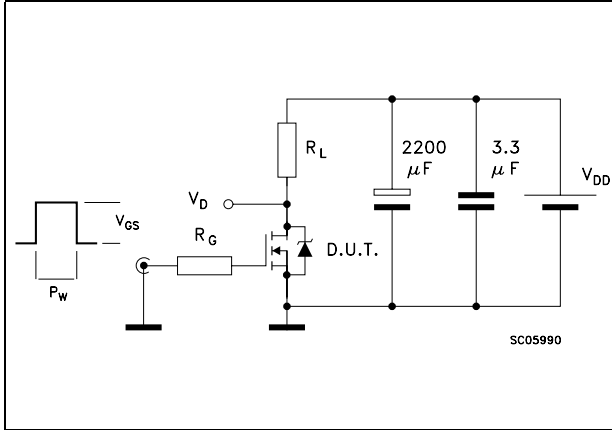

Figure 19. Gate charge test circuit



Figure 20. Test circuit for inductive load switching and diode recovery times

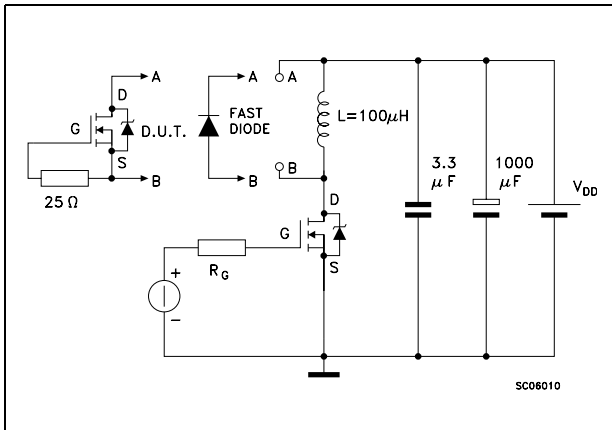

Figure 21. Unclamped inductive load test circuit



Figure 22. Unclamped inductive waveform

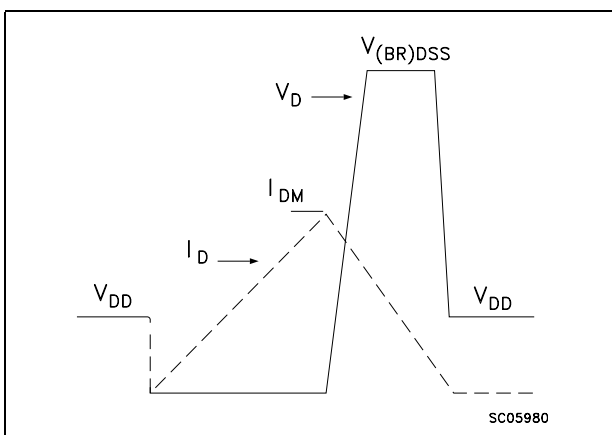

Figure 23. Switching time waveform



4 Package mechanical data

In order to meet environmental requirements, ST offers these devices in ECOPACK® packages. These packages have a Lead-free second level interconnect. The category of second level interconnect is marked on the package and on the inner box label, in compliance with JEDEC Standard JESD97. The maximum ratings related to soldering conditions are also marked on the inner box label. ECOPACK is an ST trademark. ECOPACK specifications are available at: www.st.com

TO-220 mechanical data

Dim	mm			inch		
	Min	Typ	Max	Min	Typ	Max
A	4.40		4.60	0.173		0.181
b	0.61		0.88	0.024		0.034
b1	1.14		1.70	0.044		0.066
c	0.48		0.70	0.019		0.027
D	15.25		15.75	0.6		0.62
D1		1.27			0.050	
E	10		10.40	0.393		0.409
e	2.40		2.70	0.094		0.106
e1	4.95		5.15	0.194		0.202
F	1.23		1.32	0.048		0.051
H1	6.20		6.60	0.244		0.256
J1	2.40		2.72	0.094		0.107
L	13		14	0.511		0.551
L1	3.50		3.93	0.137		0.154
L20		16.40			0.645	
L30		28.90			1.137	
∅P	3.75		3.85	0.147		0.151
Q	2.65		2.95	0.104		0.116

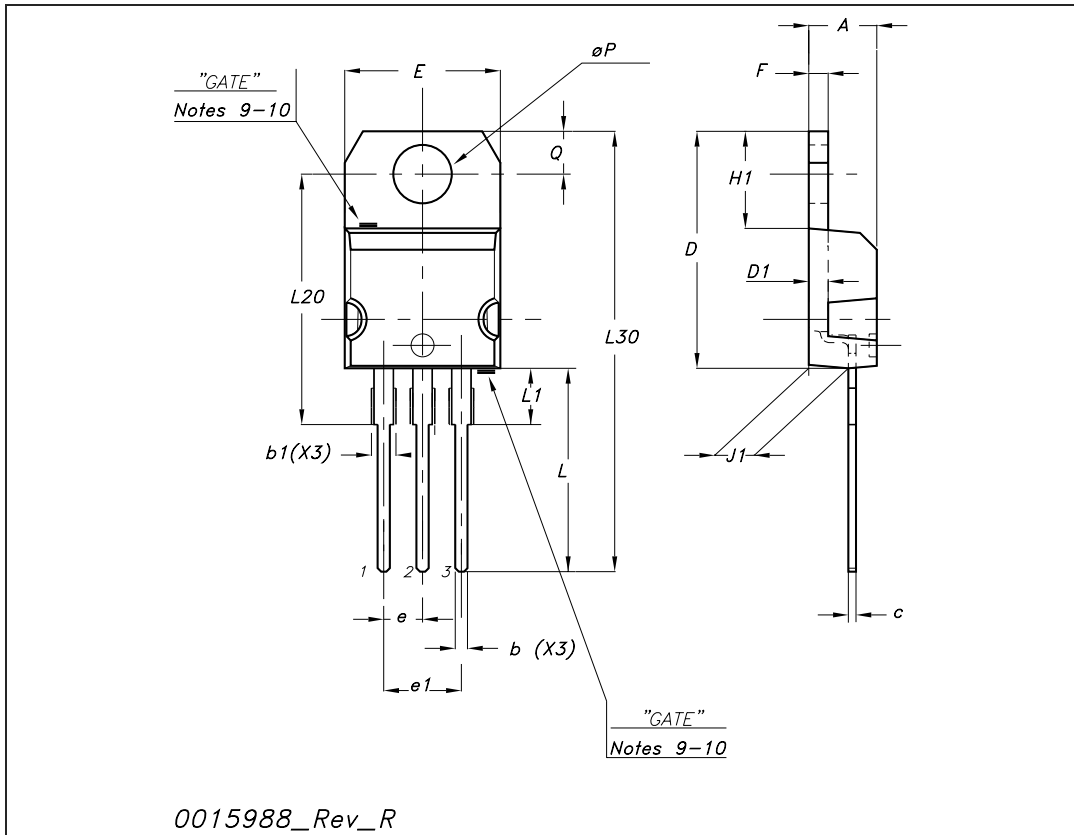

TO-220FP MECHANICAL DATA

DIM.	mm.			inch		
	MIN.	TYP	MAX.	MIN.	TYP.	MAX.
A	4.4		4.6	0.173		0.181
B	2.5		2.7	0.098		0.106
D	2.5		2.75	0.098		0.108
E	0.45		0.7	0.017		0.027
F	0.75		1	0.030		0.039
F1	1.15		1.7	0.045		0.067
F2	1.15		1.7	0.045		0.067
G	4.95		5.2	0.195		0.204
G1	2.4		2.7	0.094		0.106
H	10		10.4	0.393		0.409
L2		16			0.630	
L3	28.6		30.6	1.126		1.204
L4	9.8		10.6	.0385		0.417
L5	2.9		3.6	0.114		0.141
L6	15.9		16.4	0.626		0.645
L7	9		9.3	0.354		0.366
Ø	3		3.2	0.118		0.126

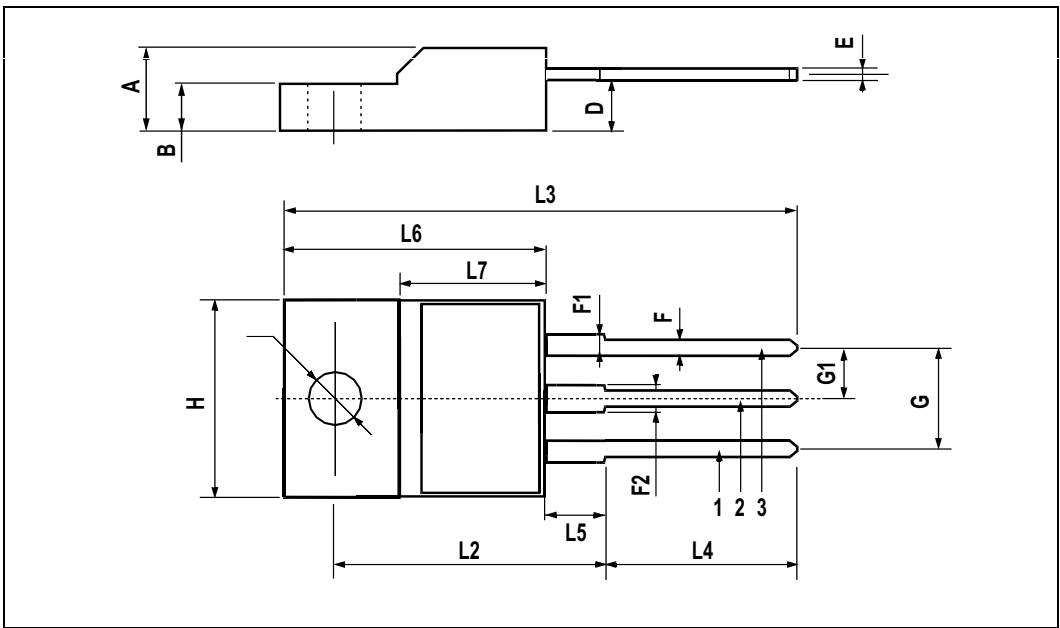

TO-251 (IPAK) mechanical data

DIM.	mm.		
	min.	typ	max.
A	2.20		2.40
A1	0.90		1.10
b	0.64		0.90
b2			0.95
b4	5.20		5.40
c	0.45		0.60
c2	0.48		0.60
D	6.00		6.20
E	6.40		6.60
e		2.28	
e1	4.40		4.60
H		16.10	
L	9.00		9.40
(L1)	0.80		1.20
L2		0.80	
V1		10°	

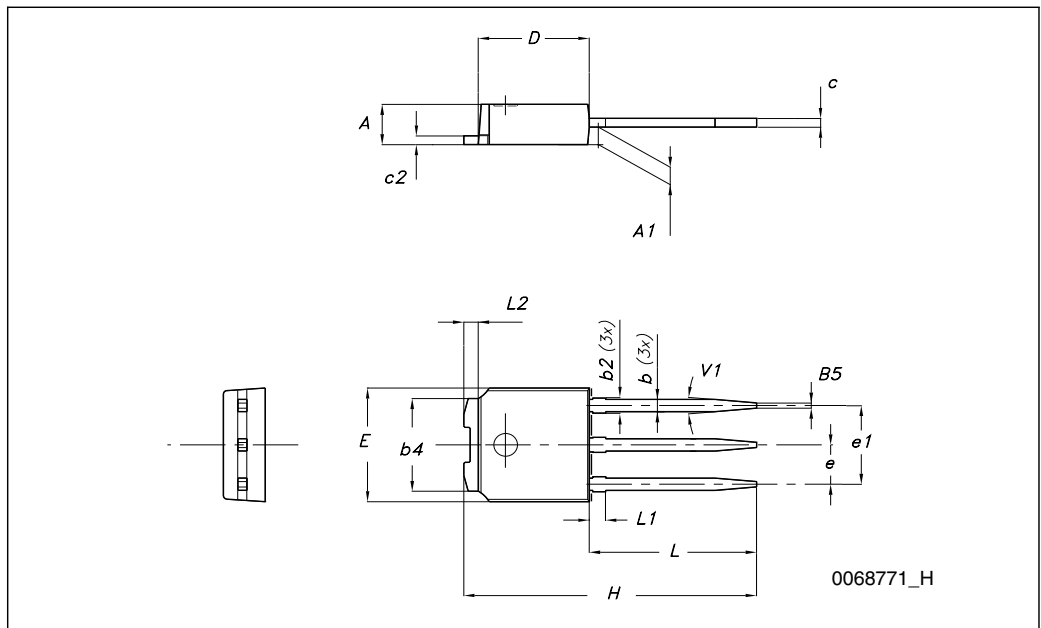

TO-252 (DPAK) mechanical data

DIM.	mm.		
	min.	typ	max.
A	2.20		2.40
A1	0.90		1.10
A2	0.03		0.23
b	0.64		0.90
b4	5.20		5.40
c	0.45		0.60
c2	0.48		0.60
D	6.00		6.20
D1		5.10	
E	6.40		6.60
E1		4.70	
e		2.28	
e1	4.40		4.60
H	9.35		10.10
L	1		
L1		2.80	
L2		0.80	
L4	0.60		1
R		0.20	
V2	0°		8°

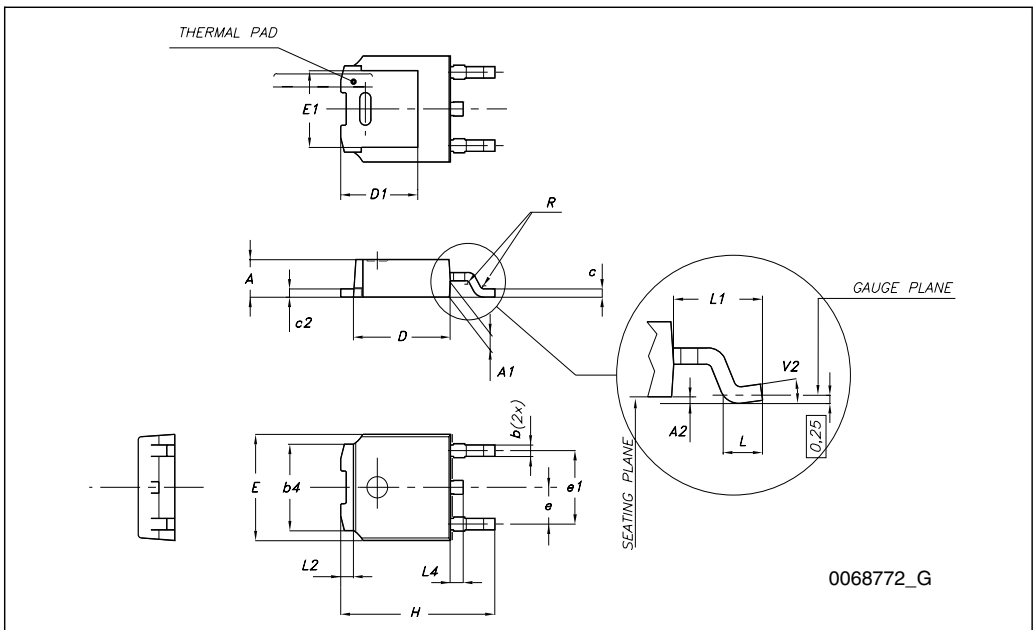

5 Package mechanical data

DPAK FOOTPRINT

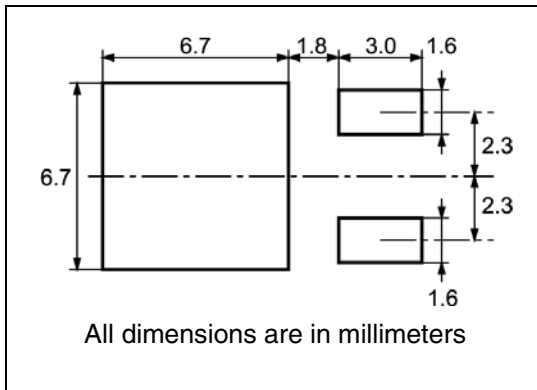

TAPE AND REEL SHIPMENT

DIM.	mm		inch	
	MIN.	MAX.	MIN.	MAX.
A		330		12.992
B	1.5		0.059	
C	12.8	13.2	0.504	0.520
D	20.2		0.795	
G	16.4	18.4	0.645	0.724
N	50		1.968	
T		22.4		0.881

BASE QTY	BULK QTY
2500	2500

DIM.	mm		inch	
	MIN.	MAX.	MIN.	MAX.
A0	6.8	7	0.267	0.275
B0	10.4	10.6	0.409	0.417
B1		12.1		0.476
D	1.5	1.6	0.059	0.063
D1	1.5		0.059	
E	1.65	1.85	0.065	0.073
F	7.4	7.6	0.291	0.299
K0	2.55	2.75	0.100	0.108
P0	3.9	4.1	0.153	0.161
P1	7.9	8.1	0.311	0.319
P2	1.9	2.1	0.075	0.082
R	40		1.574	
W	15.7	16.3	0.618	0.641

TRL

FEED DIRECTION

Bending radius R min.

6 Revision history

Table 9. Document revision history

Date	Revision	Changes
26-Oct-2007	1	Initial release.
07-Feb-2008	2	Document status promoted from preliminary data to datasheet.
14-Oct-2008	3	Table 4: Avalanche characteristics has been corrected.

Please Read Carefully:

Information in this document is provided solely in connection with ST products. STMicroelectronics NV and its subsidiaries ("ST") reserve the right to make changes, corrections, modifications or improvements, to this document, and the products and services described herein at any time, without notice.

All ST products are sold pursuant to ST's terms and conditions of sale.

Purchasers are solely responsible for the choice, selection and use of the ST products and services described herein, and ST assumes no liability whatsoever relating to the choice, selection or use of the ST products and services described herein.

No license, express or implied, by estoppel or otherwise, to any intellectual property rights is granted under this document. If any part of this document refers to any third party products or services it shall not be deemed a license grant by ST for the use of such third party products or services, or any intellectual property contained therein or considered as a warranty covering the use in any manner whatsoever of such third party products or services or any intellectual property contained therein.

UNLESS OTHERWISE SET FORTH IN ST'S TERMS AND CONDITIONS OF SALE ST DISCLAIMS ANY EXPRESS OR IMPLIED WARRANTY WITH RESPECT TO THE USE AND/OR SALE OF ST PRODUCTS INCLUDING WITHOUT LIMITATION IMPLIED WARRANTIES OF MERCHANTABILITY, FITNESS FOR A PARTICULAR PURPOSE (AND THEIR EQUIVALENTS UNDER THE LAWS OF ANY JURISDICTION), OR INFRINGEMENT OF ANY PATENT, COPYRIGHT OR OTHER INTELLECTUAL PROPERTY RIGHT.

UNLESS EXPRESSLY APPROVED IN WRITING BY AN AUTHORIZED ST REPRESENTATIVE, ST PRODUCTS ARE NOT RECOMMENDED, AUTHORIZED OR WARRANTED FOR USE IN MILITARY, AIR CRAFT, SPACE, LIFE SAVING, OR LIFE SUSTAINING APPLICATIONS, NOR IN PRODUCTS OR SYSTEMS WHERE FAILURE OR MALFUNCTION MAY RESULT IN PERSONAL INJURY, DEATH, OR SEVERE PROPERTY OR ENVIRONMENTAL DAMAGE. ST PRODUCTS WHICH ARE NOT SPECIFIED AS "AUTOMOTIVE GRADE" MAY ONLY BE USED IN AUTOMOTIVE APPLICATIONS AT USER'S OWN RISK.

Resale of ST products with provisions different from the statements and/or technical features set forth in this document shall immediately void any warranty granted by ST for the ST product or service described herein and shall not create or extend in any manner whatsoever, any liability of ST.

ST and the ST logo are trademarks or registered trademarks of ST in various countries.

Information in this document supersedes and replaces all information previously supplied.

The ST logo is a registered trademark of STMicroelectronics. All other names are the property of their respective owners.

© 2008 STMicroelectronics - All rights reserved

STMicroelectronics group of companies

Australia - Belgium - Brazil - Canada - China - Czech Republic - Finland - France - Germany - Hong Kong - India - Israel - Italy - Japan - Malaysia - Malta - Morocco - Singapore - Spain - Sweden - Switzerland - United Kingdom - United States of America

www.st.com

