

GENERAL DESCRIPTION

The IDTF2255 is a low insertion loss **V**oltage **V**ariable RF **A**ttenuator (VVA) designed for a multitude of wireless and other RF applications. This device covers a broad frequency range from 1MHz to 3000MHz. In addition to providing low insertion loss, the IDTF2255 provides excellent linearity performance over its entire voltage control and attenuation range.

The F2255 uses a single positive supply voltage of 3.15V to 5.25V. Other features include the V_{MODE} pin allowing either positive or negative voltage control slope vs attenuation and multi-directional operation meaning the RF input can be applied to either RF1 or RF2 pins. Control voltage ranges from 0V to 3.6V using either positive or negative control voltage slope.

COMPETITIVE ADVANTAGE

IDTF2255 provides extremely low insertion loss and superb IP3, IP2, Return Loss and Slope Linearity across the control range. Comparing to competitive VVAs this device is better as follows:

- ✓ Operation down to 1MHz
- ✓ Insertion Loss @ 500MHz: 1.1dB
- ✓ Maximum Attenuation Slope: 33dB/Volt
- ✓ Minimum Output IP3: 35dBm
- ✓ Minimum Input IP2: 74dBm
- ✓ High Operating Temperature: +105°C

APPLICATIONS

- Base Station 2G, 3G, 4G
- Portable Wireless
- Repeaters and E911 systems
- Digital Pre-Distortion
- Point to Point Infrastructure
- Public Safety Infrastructure
- Satellite Receivers and Modems
- WIMAX Receivers and Transmitters
- Military Radios covering HF, VHF, UHF
- RFID handheld and portable readers
- Cable Infrastructure
- Wireless LAN
- Test / ATE Equipment

FEATURES

- Low Insertion Loss: 1.1dB @ 500MHz
- Typical / Min IIP3: 60dBm / 46dBm
- Typical / Min IIP2: 98dBm / 74dBm
- 33dB Attenuation Range
- Bi-directional RF ports
- +36dBm Input P1dB compression
- V_{MODE} pin allows either positive or negative control response
- Linear-in-dB attenuation characteristic
- Supply voltage: 3.15V to 5.25V
- V_{CTRL} range: 0V to 3.6V using 5V supply
- +105°C max operating temperature
- 3mm x 3mm, 16-pin QFN package

DEVICE BLOCK DIAGRAM

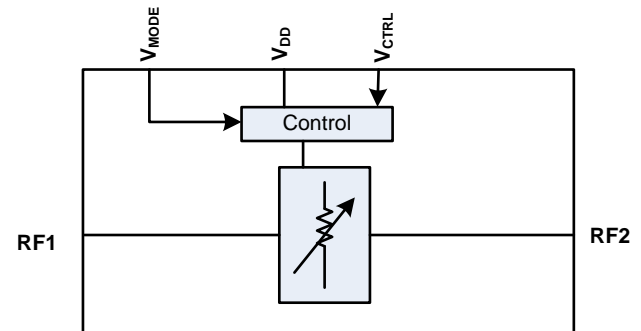

ORDERING INFORMATION



PART# MATRIX

Part#	RF Freq Range (MHz)	Insertion Loss (dB)	IIP3 (dBm)	Pinout Compatibility
F2250	50 - 6000	1.4 (at 2GHz)	+65	RFMD
F2255	1 - 3000	1.1 (at 500MHz)	+60	
F2258	50 - 6000	1.4 (at 2GHz)	+65	Hittite

ABSOLUTE MAXIMUM RATINGS

Parameter / Condition	Symbol	Min	Max	Units
V _{DD} to GND	V _{DD}	-0.3	5.5	V
V _{MODE} to GND	V _{MODE}	-0.3	Minimum (V _{DD} , 3.9)	V
V _{CTRL} to GND	V _{CTRL}	-0.3	Minimum (V _{DD} , 4.0)	V
RF1, RF2 to GND	V _{RF}	-0.3	0.3	V
RF1 or RF2 Input Power applied for 24 hours maximum (V _{DD} applied @ 2GHz and T _c =+85°C)	P _{MAX24}		30	dBm
RF1 or RF2 Continuous Operating Power	P _{MAX_OP}		See Figure 1	dBm
Maximum Junction Temperature	T _{JMAX}		+150	°C
Storage Temperature Range	T _{ST}	-65	+150	°C
Lead Temperature (soldering, 10s)	T _{LEAD}		+260	°C
ESD Voltage– HBM (Per ESD STM5.1-2007)	V _{ESDHBM}		Class 2	
ESD Voltage – CDM (Per ESD STM5.3.1-2009)	V _{ESDCDM}		Class C3	

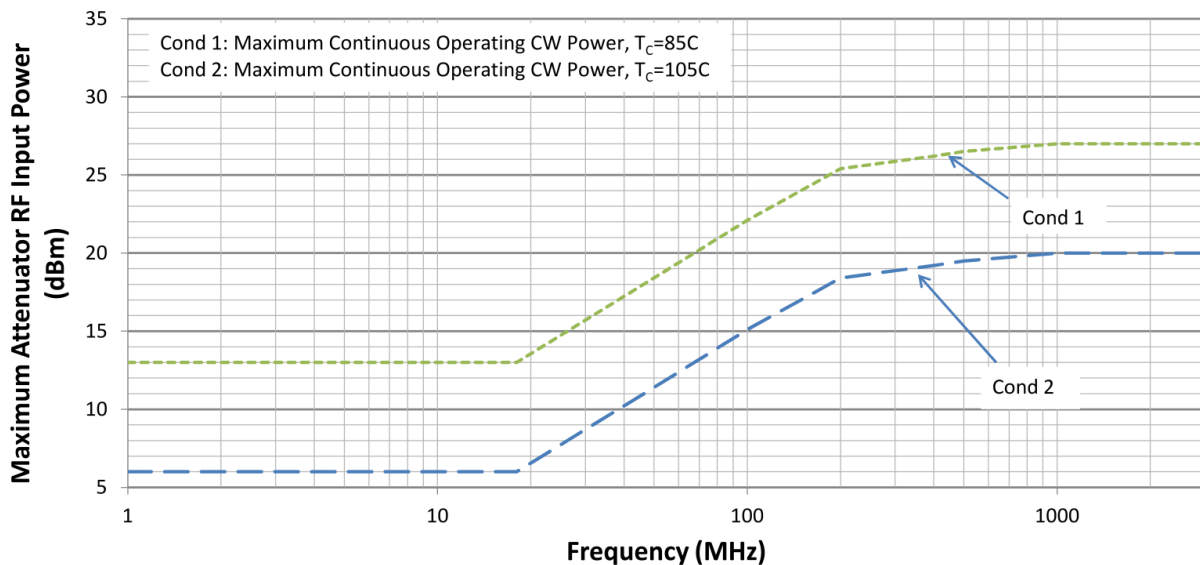

FIGURE 1: MAXIMUM OPERATING RF INPUT POWERS VS. RF FREQUENCY

Stresses above those listed above may cause permanent damage to the device. Functional operation of the device at these or any other conditions above those indicated in the operational section of this specification is not implied. Exposure to absolute maximum rating conditions for extended periods may affect device reliability.

PACKAGE THERMAL AND MOISTURE CHARACTERISTICS

Θ _{JA} (Junction – Ambient)	80.6°C/W
Θ _{JC} (Junction – Case) The Case is defined as the exposed paddle	5.1°C/W
Moisture Sensitivity Rating (Per J-STD-020)	MSL 1

IDTF2255 OPERATING CONDITIONS

Parameter	Symbol	Condition	Min	Typ	Max	Units
Operating Frequency Range	f_{RF}		1		3000	MHz
Supply Voltage	V_{DD}		3.15		5.25	V
V_{MODE} Logic	V_{IH}	$V_{DD} > 3.9V$	1.17		3.6 ²	V
		$V_{DD} = 3.15$ to 3.9V	1.17		$V_{DD} - 0.3V$	
	V_{IL}		0		0.63	
V_{CTRL} Range	V_{CTRL}	$V_{DD} = 3.9V$ to 5.25V	0		3.6	V
		$V_{DD} = 3.15V$ to 3.9V	0		$V_{DD} - 0.3$	
Supply Current	I_{DD}		0.50 ¹	1.15	2	mA
Logic Current	I_{MODE}		-1.0		38	μA
I_{CTRL} Current	I_{CTRL}		-1.0		14	μA
RF Operating Power ³	P_{MAXCW}				See Figure 1	dBm
RF1 Port Impedance	Z_{RF1}			50		Ω
RF2 Port Impedance	Z_{RF2}			50		
Operating Temperature Range	T_{CASE}	Exposed Paddle Temperature	-40		+105	$^{\circ}C$

Operating Conditions Notes:

- 1 – Items in min/max columns in **bold italics** are Guaranteed by Test.
- 2 – Items in min/max columns that are not bold/italics are Guaranteed by Design Characterization.
- 3 – Refer to the Maximum **Operating** RF Input Power vs. RF Frequency curves in Figure 1.

IDTF2255 SPECIFICATIONS

Refer to EVKit / Applications Circuit, $V_{DD} = +3.3V$, $T_C = +25^\circ C$, signals applied to RF1 input, $F_{RF} = 500MHz$, minimum attenuation, $P_{IN} = 0dBm$ for small signal parameters, $+20dBm$ for single tone linearity tests, $+20dBm$ per tone for two tone tests, two tone delta frequency = $80MHz$, PCB board traces and connector losses are de-embedded unless otherwise noted. Refer to Typical Operating Curves for performance over entire frequency band.

Parameter	Symbol	Condition	Min	Typ	Max	Units
Insertion Loss, IL	A_{MIN}	Minimum Attenuation		1.1	1.7 ¹	dB
Maximum attenuation	A_{MAX}		33	34.6		dB
Insertion Phase Δ	$\Phi_{\Delta MAX}$	At 36dB attenuation relative to Insertion Loss		27		deg
	$\Phi_{\Delta MID}$	At 18dB attenuation relative to Insertion Loss		8		
Input 1dB Compression ³	P1dB			36		dBm
Minimum RF1 Return Loss over control voltage range	S11	20MHz		23		dB
		500MHz		22		
		2000MHz		23		
		3000MHz		30		
Minimum RF2 Return Loss over control voltage range	S22	20MHz		23		dB
		500MHz		22		
		2000MHz		23		
		3000MHz		24		
Input IP3	IIP3			60		dBm
Input IP3 over Attenuation	IIP3 _{ATTEN}	All attenuation settings	44 ²	46		
Minimum Output IP3	OIP3 _{MIN}	Maximum attenuation		35		
Input IP2	IIP2	$P_{IN} + IM2_{dBc}$, IM2 term is F1+F2		98		dBm
Minimum Input IP2	IIP2 _{MIN}	All attenuation settings		74		dBm
Input IH2	HD2	$P_{IN} + H2_{dBc}$		82		dBm
Input IH3	HD3	$P_{IN} + (H3_{dBc}/2)$		49		dBm
Settling Time	$T_{SETTL0.1dB}$	Any 1dB step in the 0dB to 33dB control range 50% V_{CTRL} to RF settled to within $\pm 0.1dB$		15		μ Sec

Specification Notes:

- 1 – Items in min/max columns in ***bold italics*** are Guaranteed by Test.
- 2 – Items in min/max columns that are not bold/italics are Guaranteed by Design Characterization.
- 3 – The input 1dB compression point is a linearity figure of merit. Refer to Absolute Maximum Ratings section along with Figure 1 for the maximum RF input power vs. RF frequency.

TYPICAL OPERATING CURVES

UNLESS OTHERWISE NOTED, THE FOLLOWING CONDITIONS APPLY:

- $V_{DD} = +3.3V$ or $+5.0V$
- $T_C = +25^{\circ}C$
- $V_{MODE} = 0V$
- RF trace and connector losses are de-embedded for S-parameters
- $P_{in} = 0dBm$ for all small signal tests
- $P_{in} = +20dBm$ for single tone linearity tests (RF1 port driven)
- $P_{in} = +20dBm/tone$ for two tone linearity tests (RF1 port driven)
- Two tone frequency spacing = 80MHz

TYPICAL OPERATING CONDITIONS [S2P BROADBAND PERFORMANCE] (-1-)

Attenuation vs. V_{CTRL}

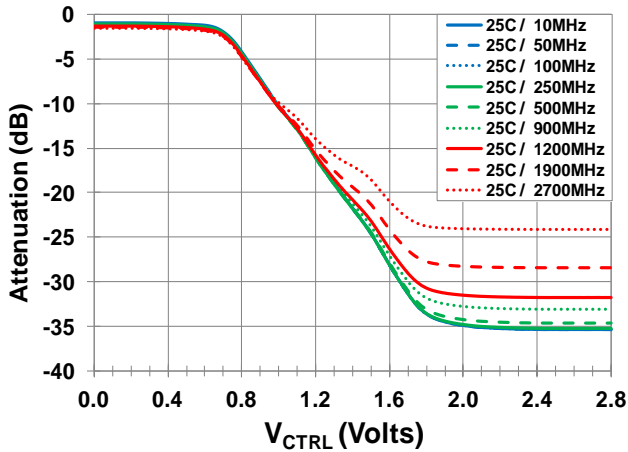

Attenuation vs. Frequency

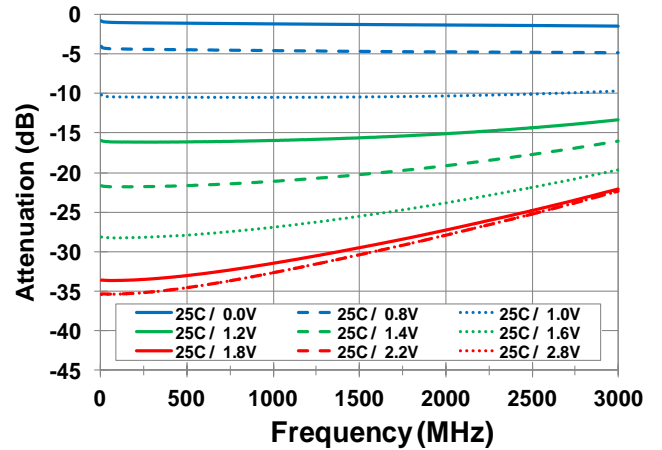

Attenuation Delta to 25C vs. V_{CTRL}

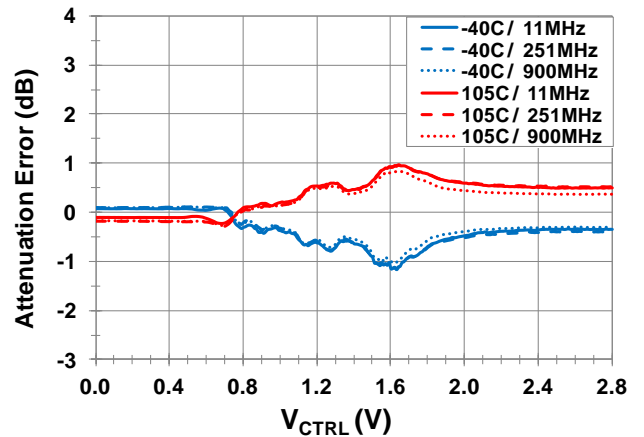

TYPICAL OPERATING CURVES [S2P vs. V_{CTRL}] (-2-)

Attenuation vs. V_{CTRL}

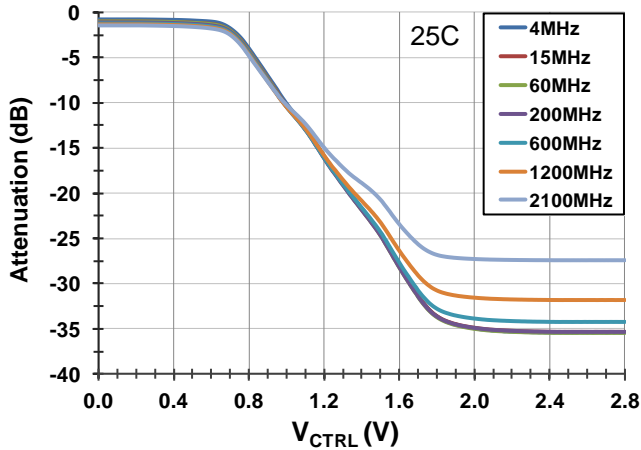

Attenuation Slope vs. V_{CTRL}

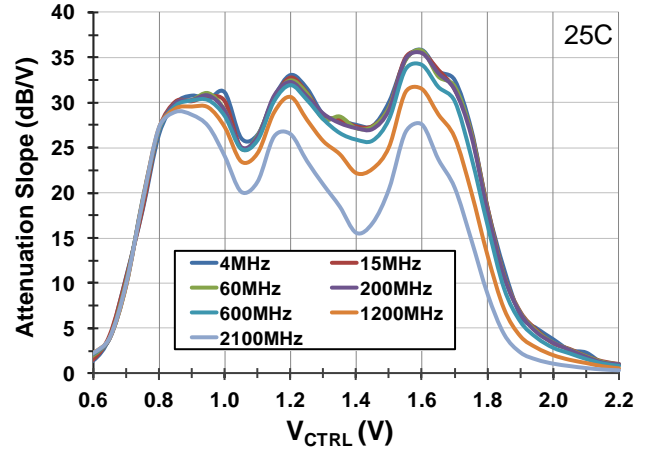

RF1 Return Loss vs. V_{CTRL}

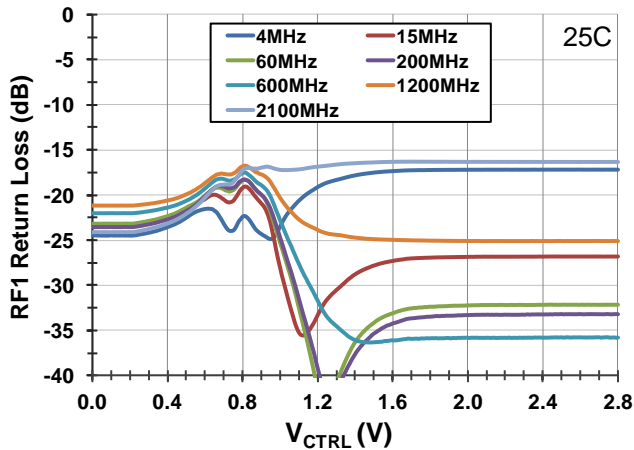

RF2 Return Loss vs. V_{CTRL}

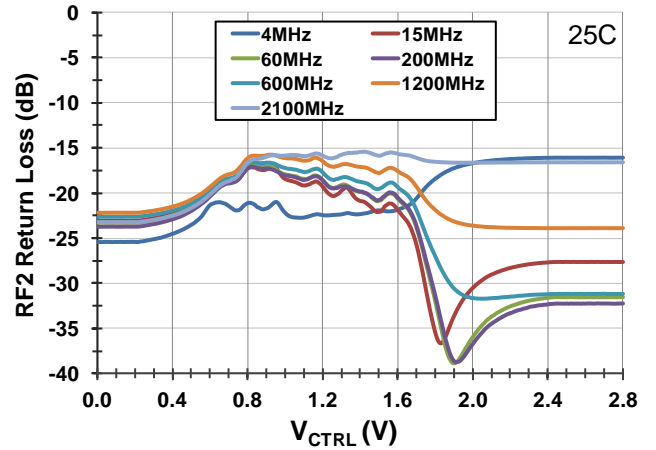

Insertion Phase Δ vs. V_{CTRL}

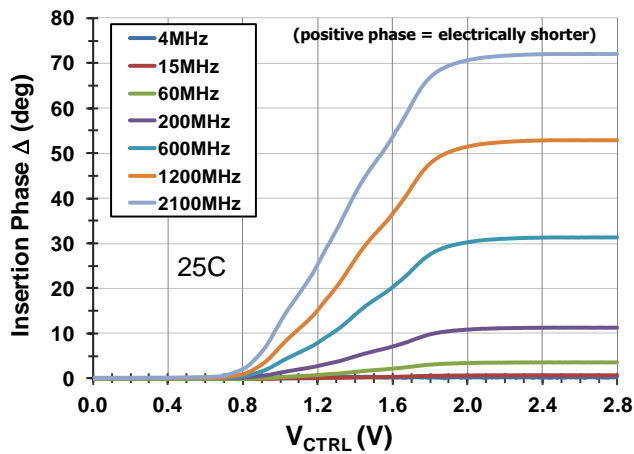

Insertion Phase Slope vs. V_{CTRL}

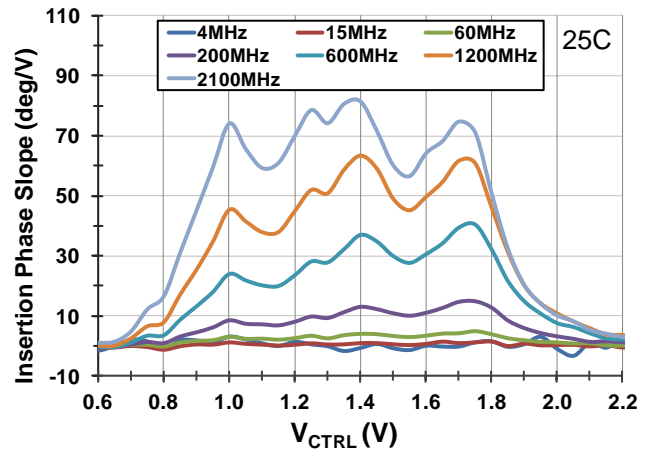

TYPICAL OPERATING CONDITIONS [S2P vs. V_{CTRL} & TEMPERATURE] (-3-)

Attenuation Response vs. V_{CTRL}

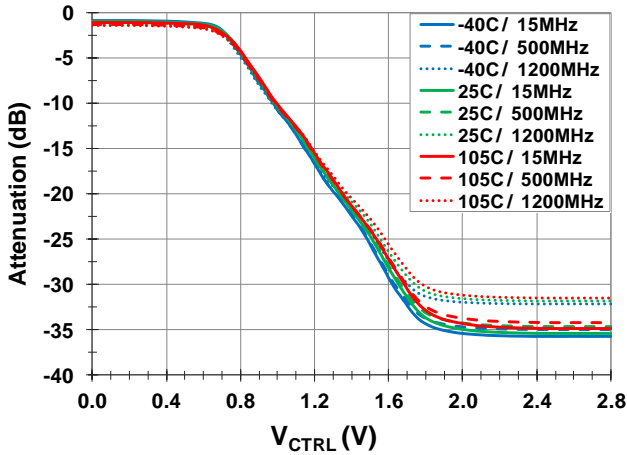

Attenuation Slope vs. V_{CTRL}

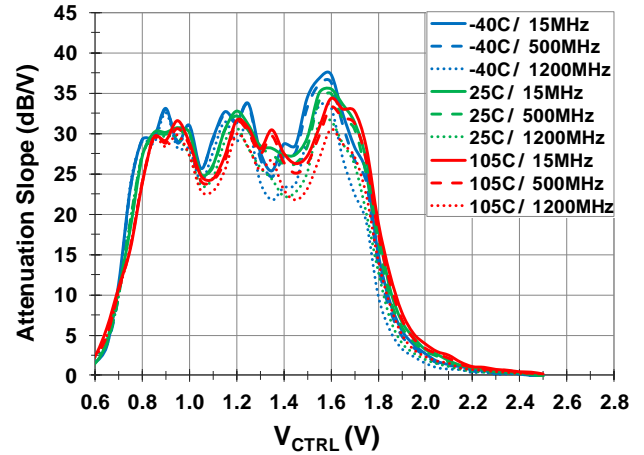

RF1 Return Loss vs. V_{CTRL}

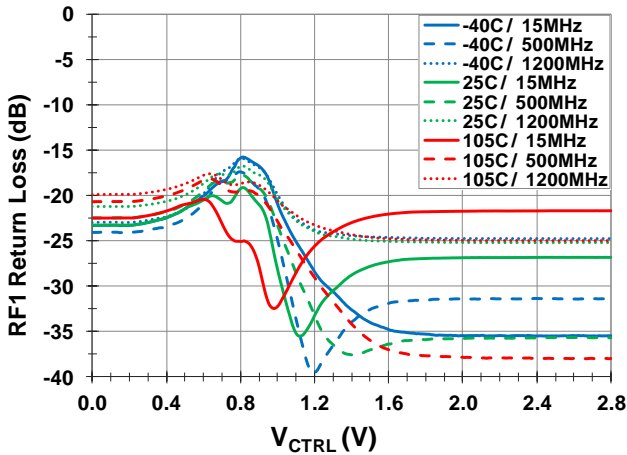

RF2 Return Loss vs. V_{CTRL}

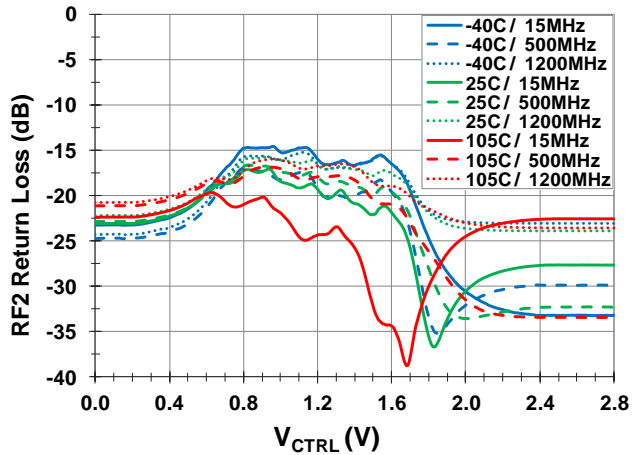

Insertion Phase Δ vs. V_{CTRL}

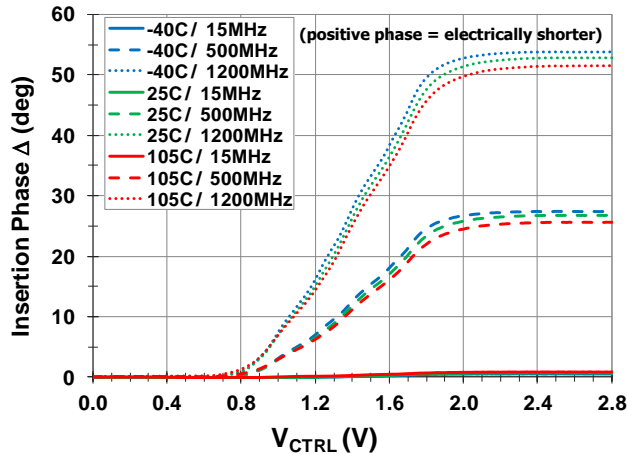

Insertion Phase Slope vs. V_{CTRL}

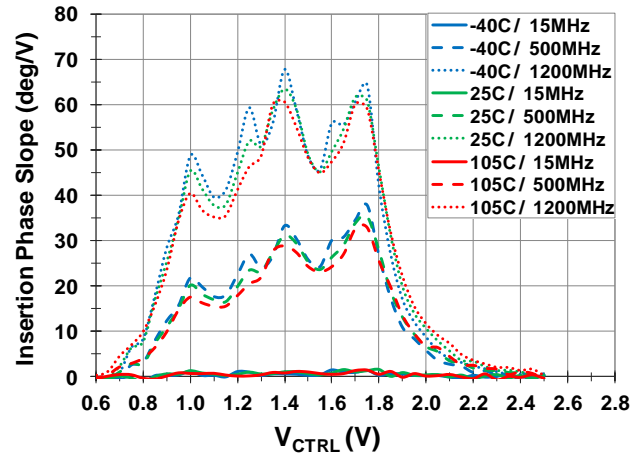

TYPICAL OPERATING CONDITIONS [S2P vs. ATTENUATION & TEMPERATURE] (-4-)

RF1 Return Loss vs. Attenuation

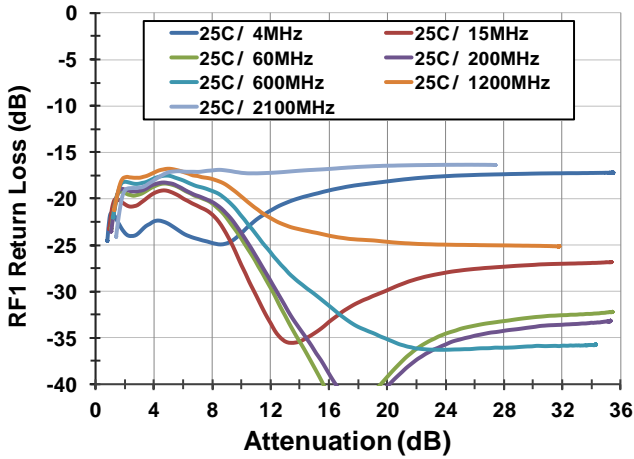

RF1 Return Loss vs. Attenuation

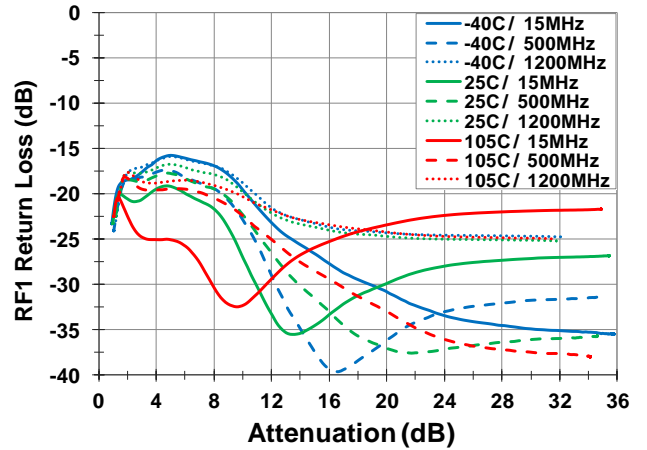

RF2 Return Loss vs. Attenuation

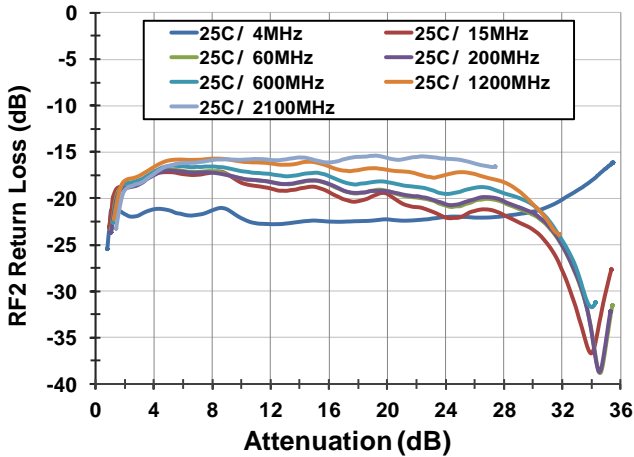

RF2 Return Loss vs. Attenuation

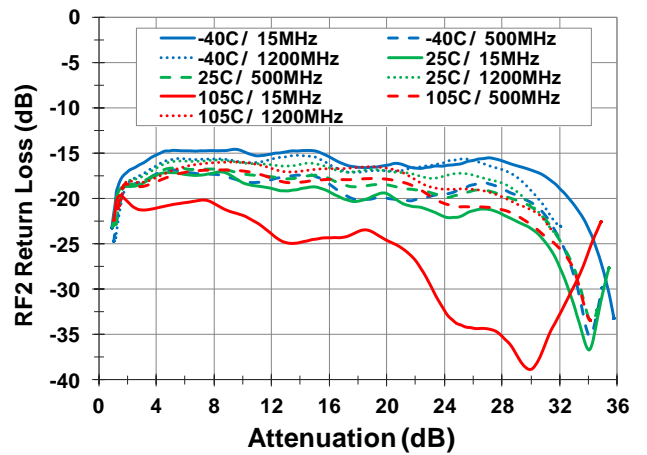

Insertion Phase Δ vs. Attenuation

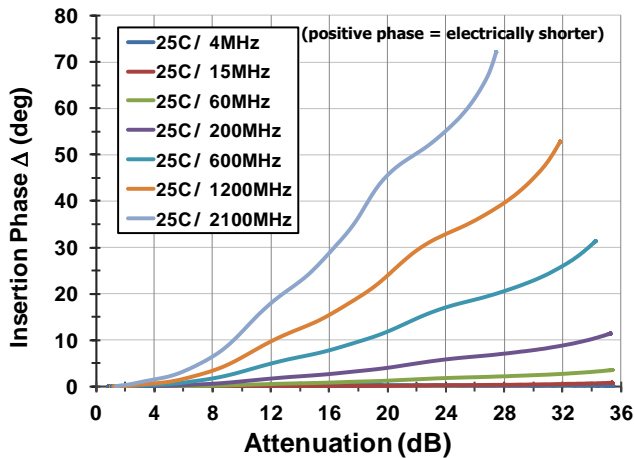

Insertion Phase Δ vs. Attenuation

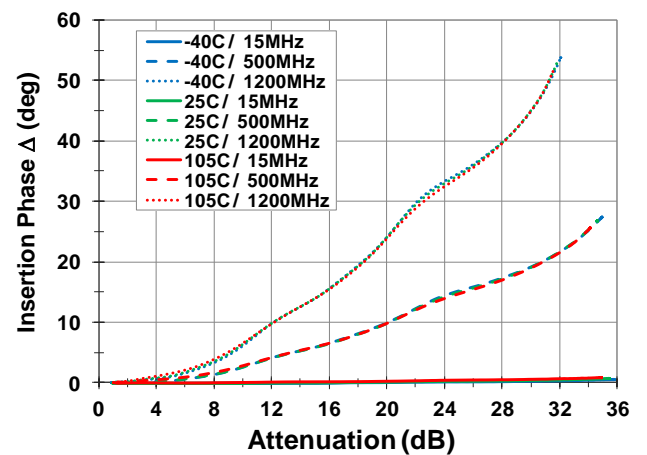

TYPICAL OPERATING CONDITIONS [S2P vs. FREQUENCY] (-5-)

Min. & Max. Attenuation vs. Frequency

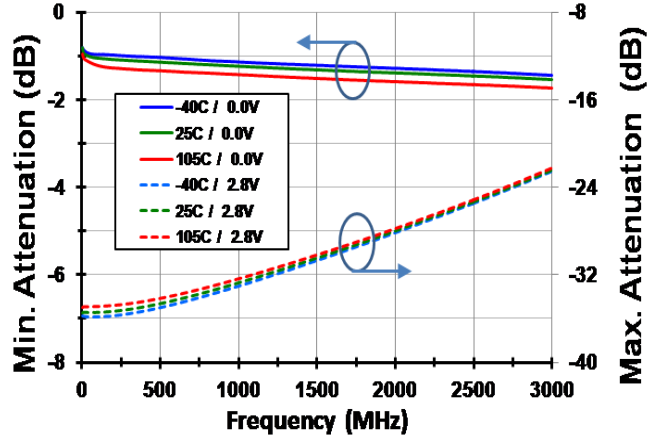

Min. & Max. Attenuation Slope vs. Frequency

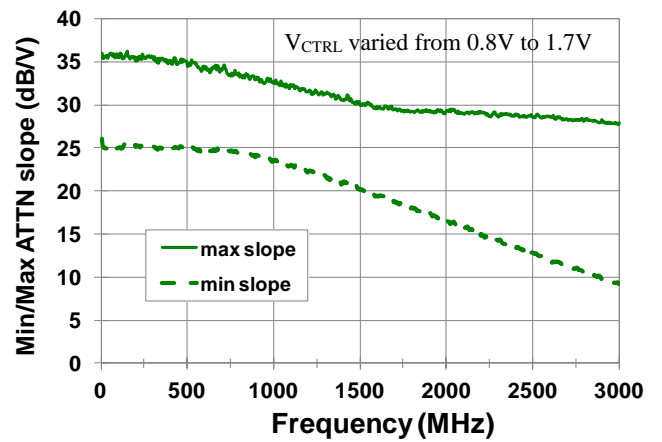

Worst-Case RF1 Return Loss vs. Frequency

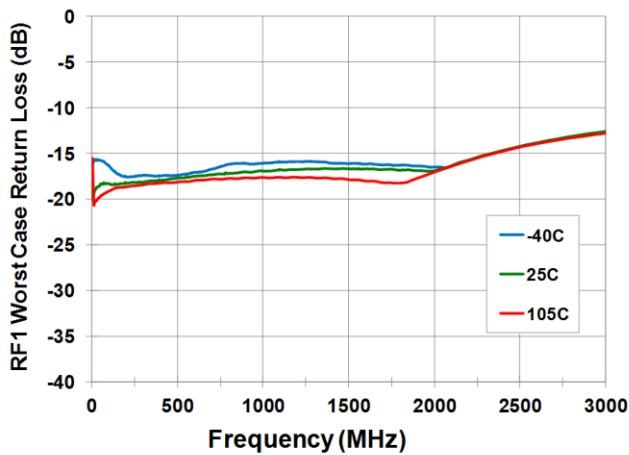

Worst-Case RF2 Return Loss vs. Frequency

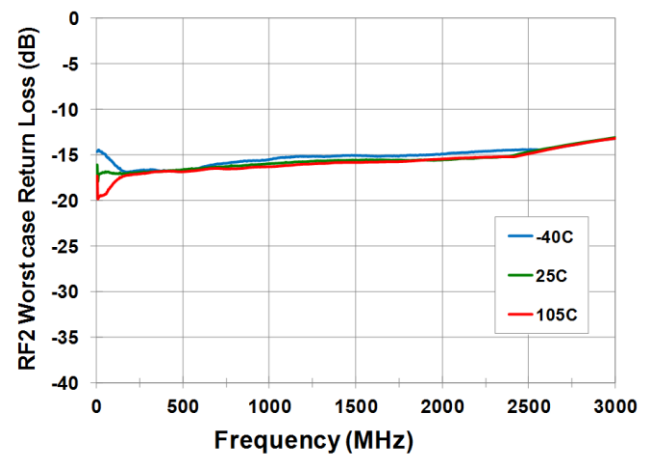

Max. Insertion Phase Δ vs. Frequency

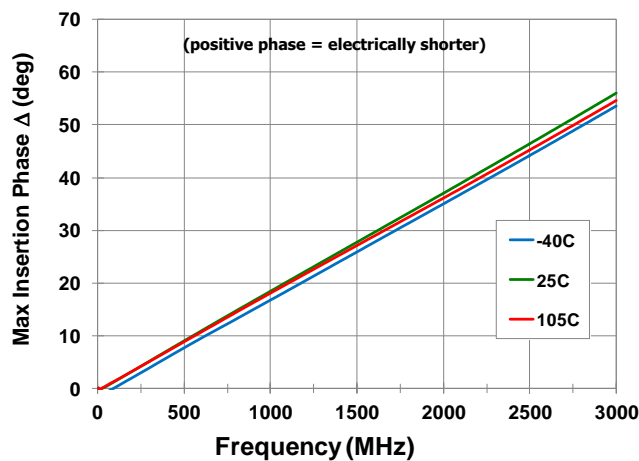

Gain Compression vs. Frequency

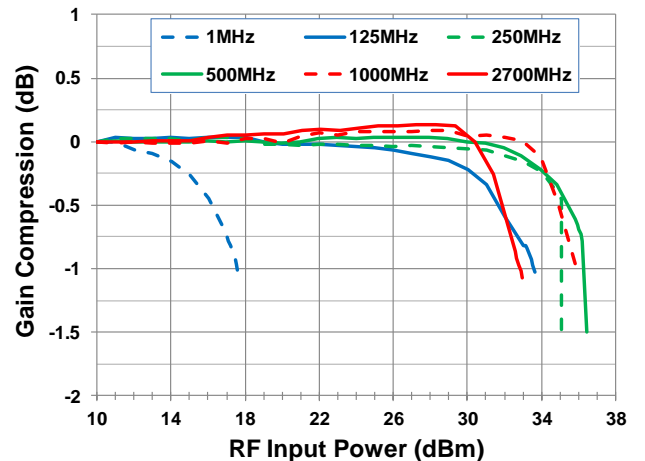

TYPICAL OPERATING CONDITIONS [S2P @ LOW FREQUENCY, GROUP DELAY] (-6-)

Min. & Max. Attenuation vs. Low Frequency

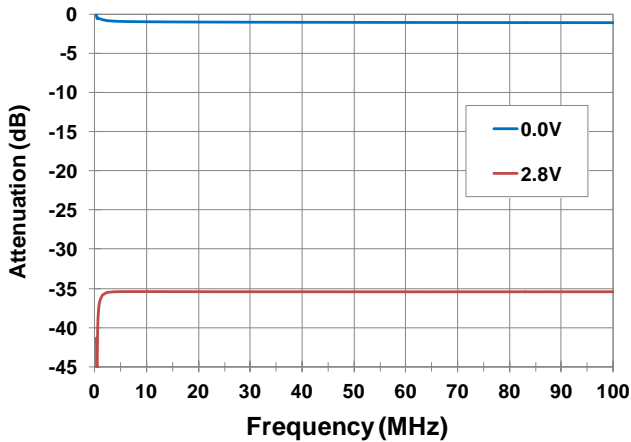

Low-Frequency Attenuation vs. V_{CTRL}

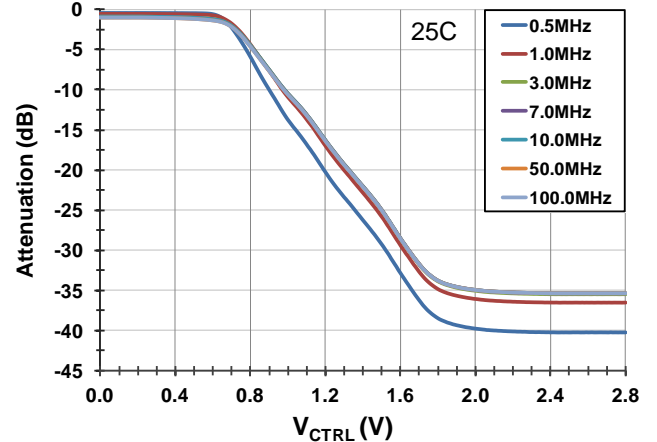

Low-Frequency RF1 Return Loss vs. V_{CTRL}

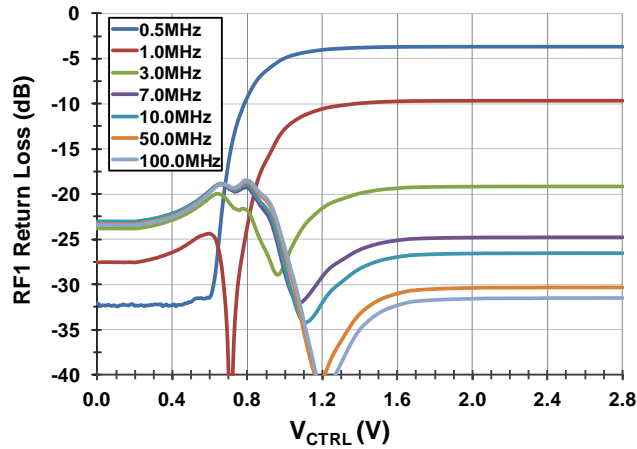

Low-Frequency RF2 Return Loss vs. V_{CTRL}

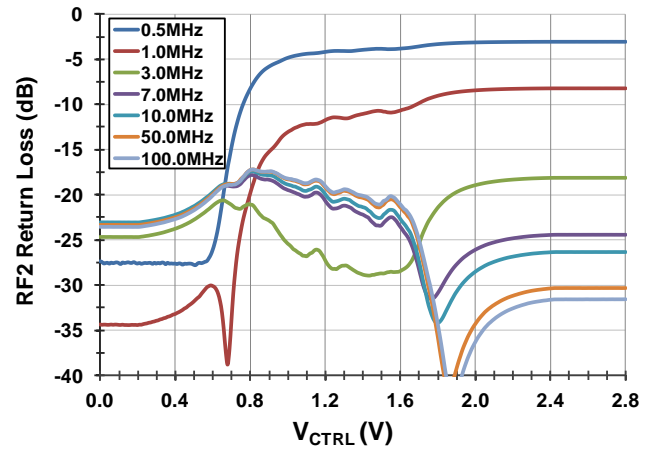

Group Delay vs. Frequency

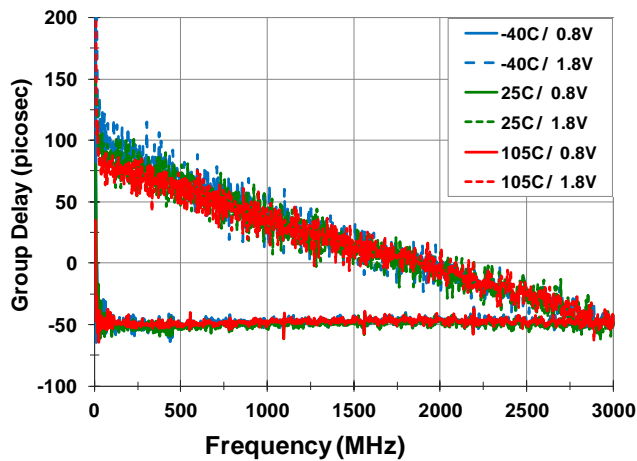

TYPICAL OPERATING CONDITIONS 500MHZ, $V_{DD}=3.3V$ [IP3, IP2, IH2, IH3 vs. V_{CTRL} , V_{MODE}] (-7-)

Input IP3 vs. V_{CTRL}

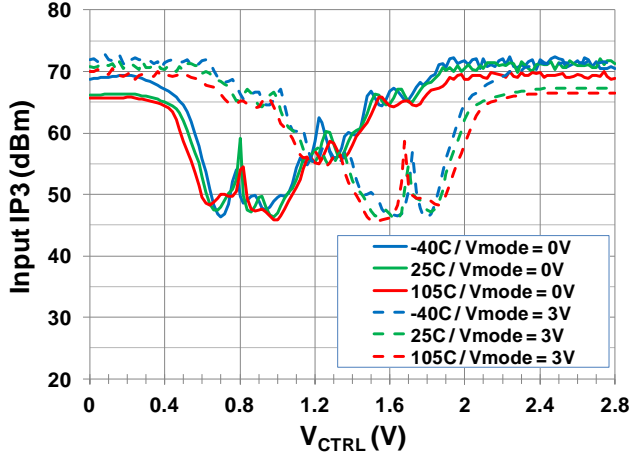

Output IP3 vs. V_{CTRL}

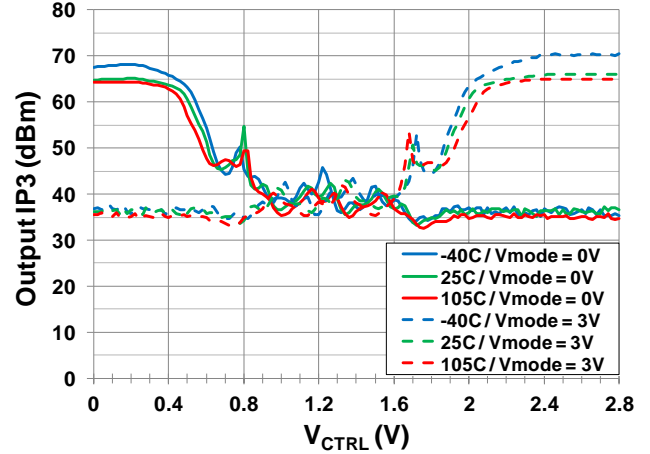

Input IP2 vs. V_{CTRL}

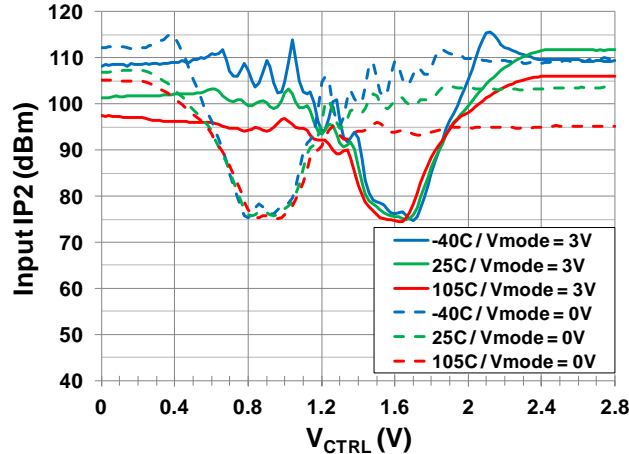

Output IP2 vs. V_{CTRL}

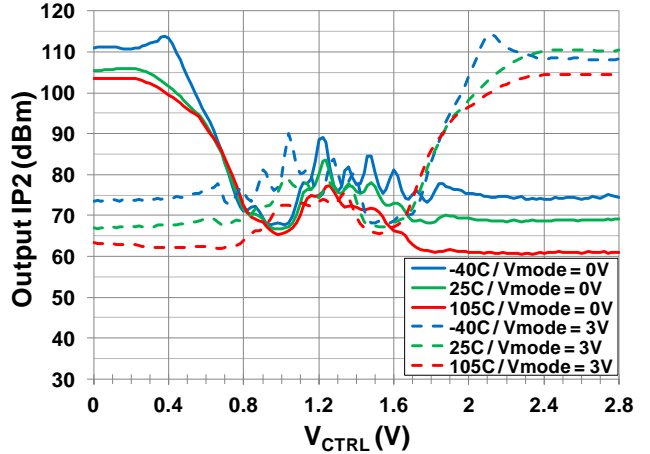

2nd Harm Input Intercept Point vs. V_{CTRL}

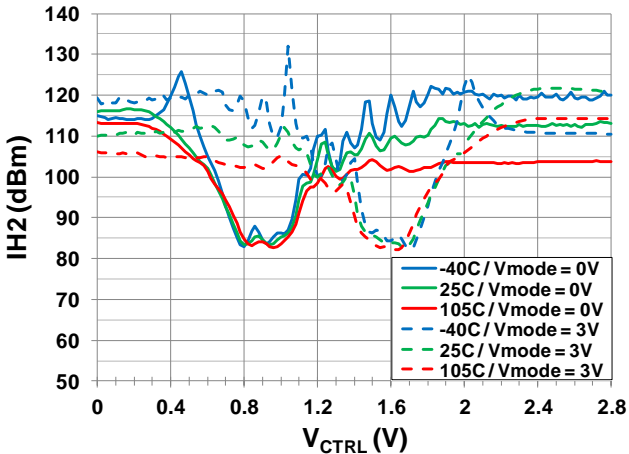

3rd Harm Input Intercept Point vs. V_{CTRL}

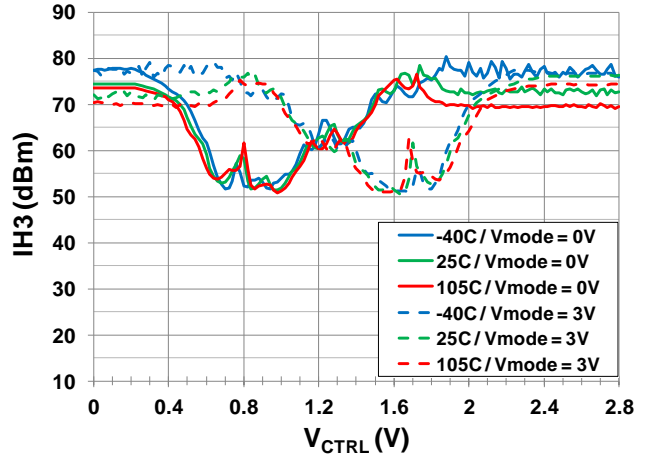

TYPICAL OPERATING CONDITIONS 500MHZ, $V_{DD}=3.3V$ [IPX, IHX vs. V_{CTRL} , RF1/RF2 DRIVEN] (-8-)

Input IP3 vs. V_{CTRL}

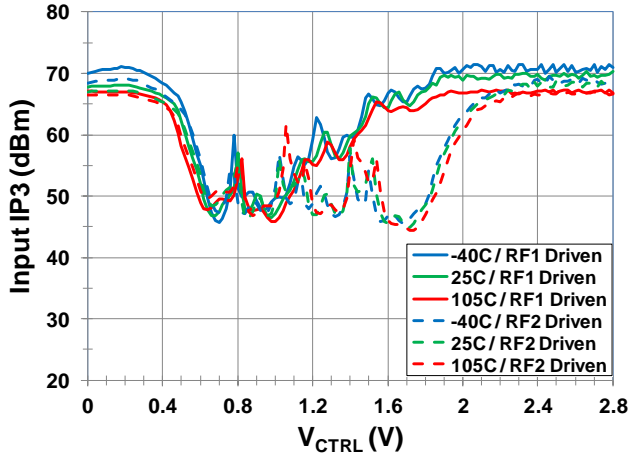

Output IP3 vs. V_{CTRL}

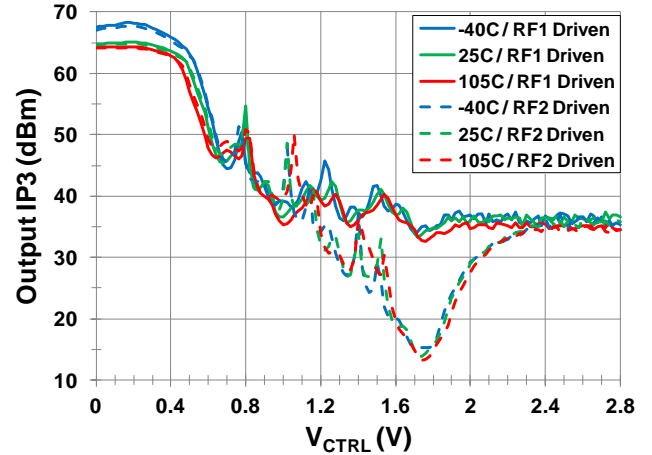

Input IP2 vs. V_{CTRL}

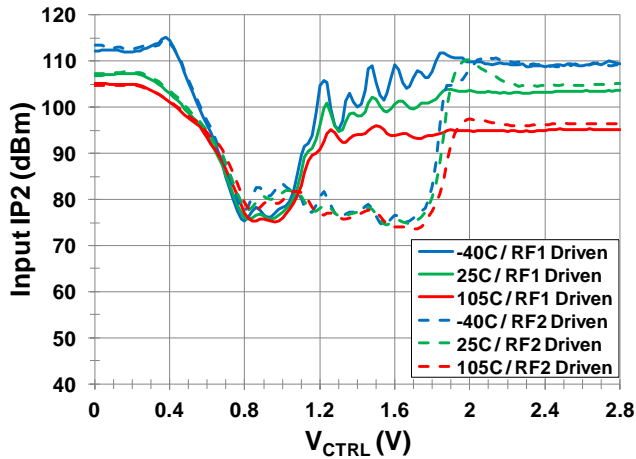

Output IP2 vs. V_{CTRL}

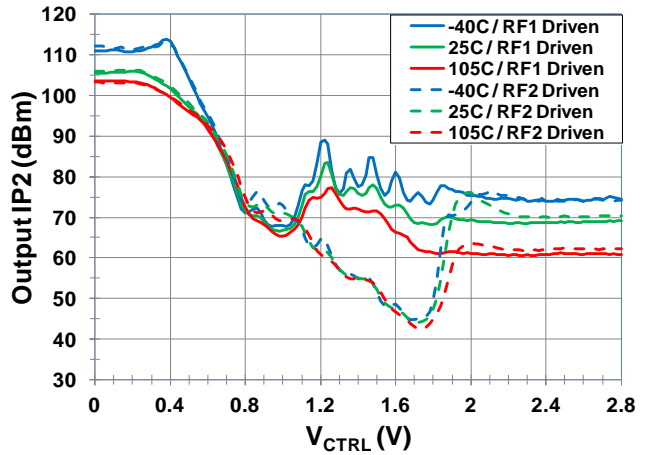

2nd Harm Input Intercept Point vs. V_{CTRL}

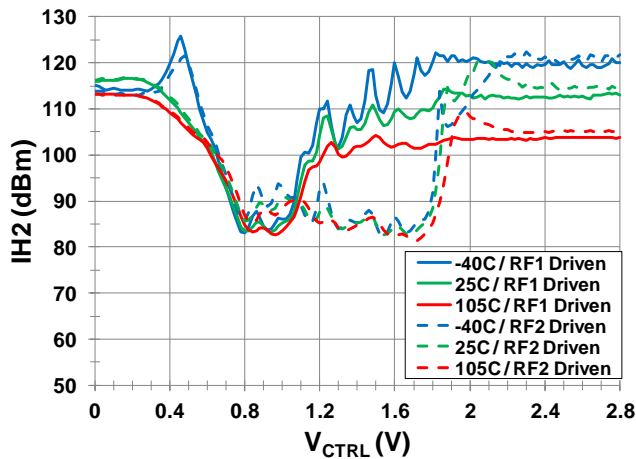

3rd Harm Input Intercept Point vs. V_{CTRL}

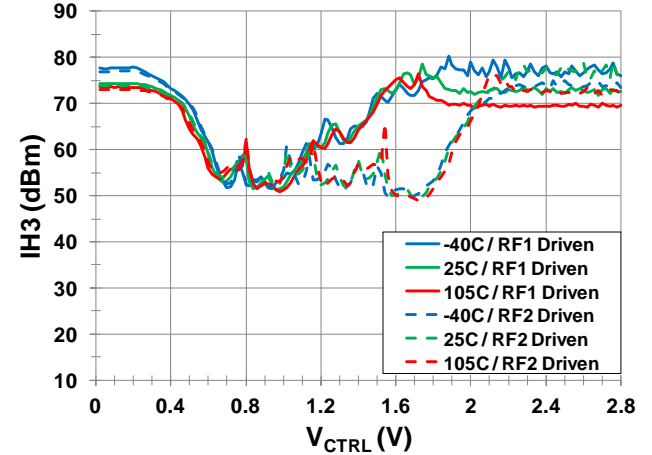

TYPICAL OPERATING CONDITIONS 500MHZ, $V_{DD}=3.3V$ [IP3, IP2, IH2, IH3 vs. ATTENUATION] (-9-)

Input IP3 vs. Attenuation

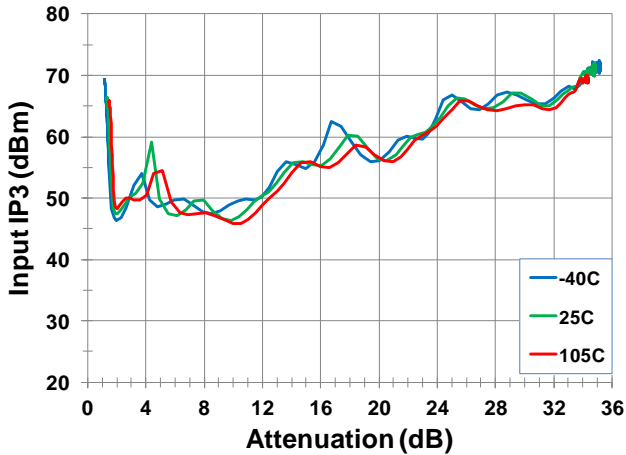

Output IP3 vs. Attenuation

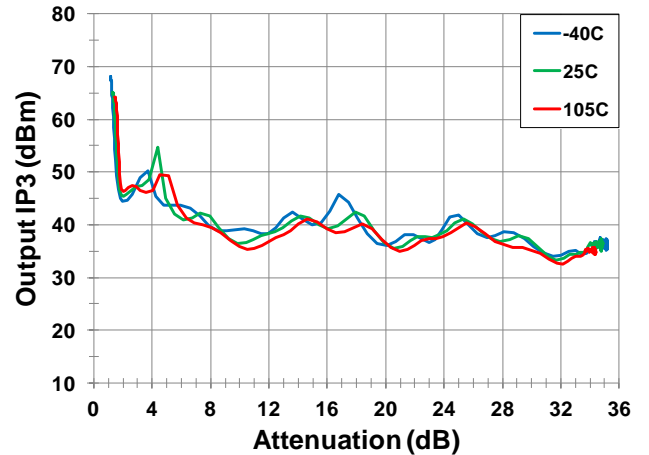

Input IP2 vs. Attenuation

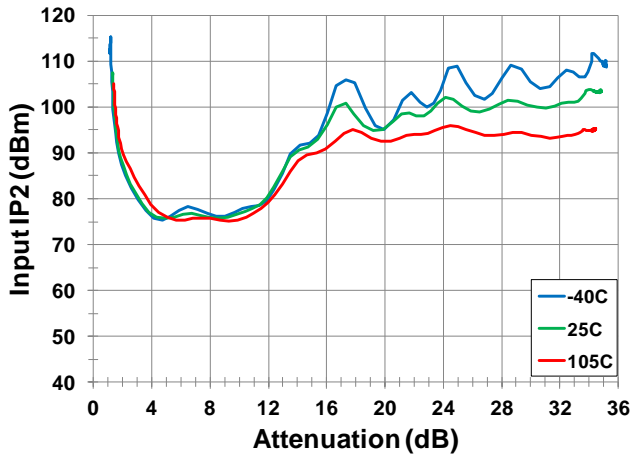

Output IP2 vs. Attenuation

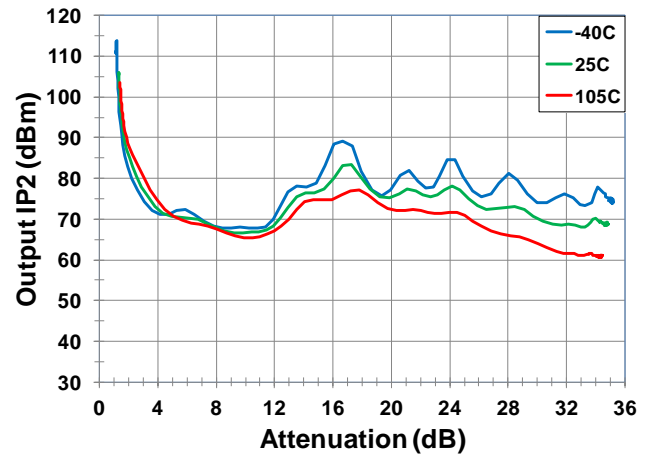

2nd Harm Input Intercept Point vs. Attenuation

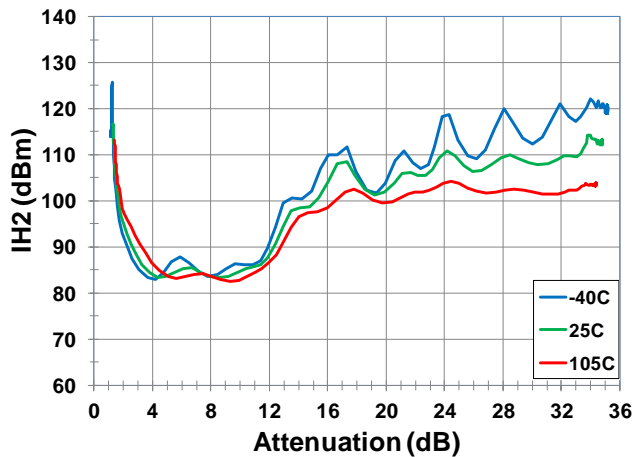

3rd Harm Input Intercept Point vs. Attenuation

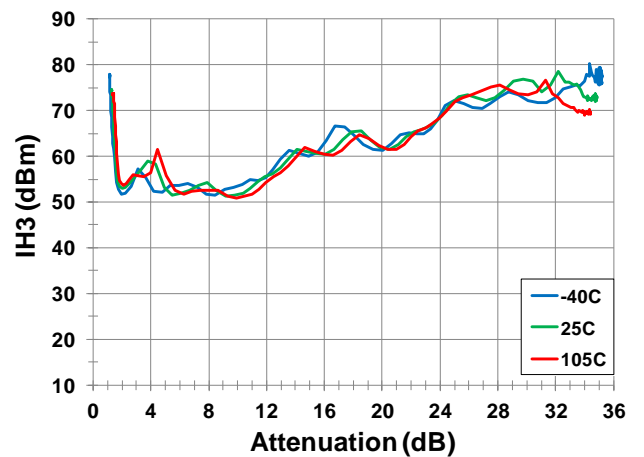

TYPICAL OPERATING CONDITIONS 500MHZ, $V_{DD}=3.3V$ [IP_X, IH_X vs. ATTEN, RF1/RF2 DRIVEN] (-10-)

Input IP3 vs. Attenuation

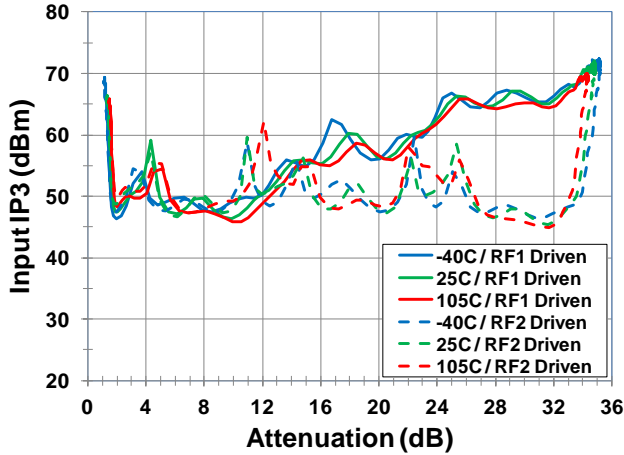

Output IP3 vs. Attenuation

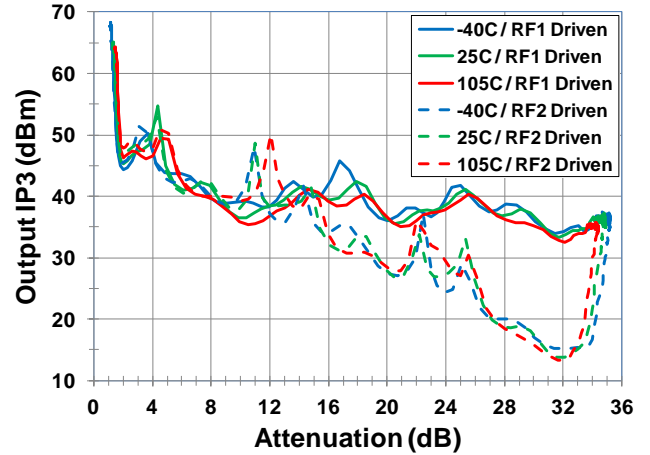

Input IP2 vs. Attenuation

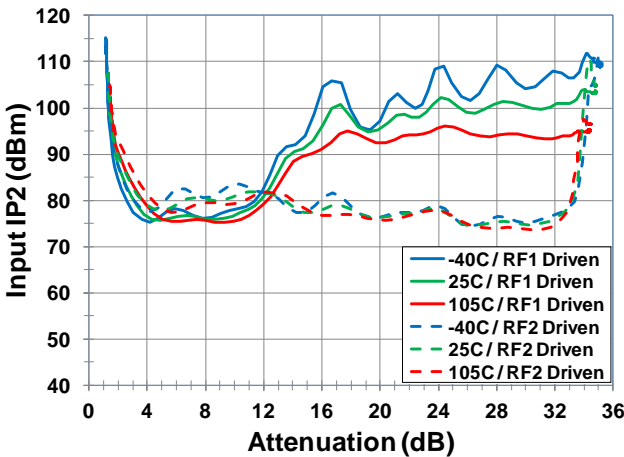

Output IP2 vs. Attenuation

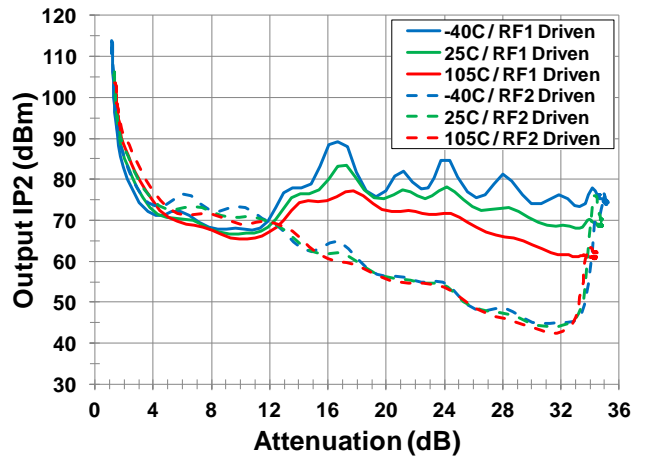

2nd Harm Input Intercept Point vs. Attenuation

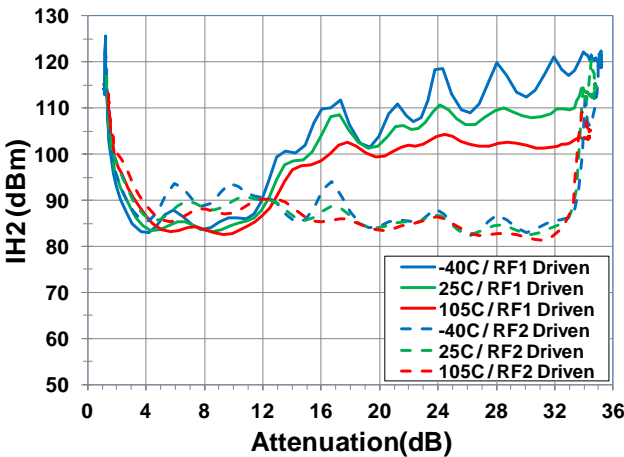

3rd Harm Input Intercept Point vs. Attenuation

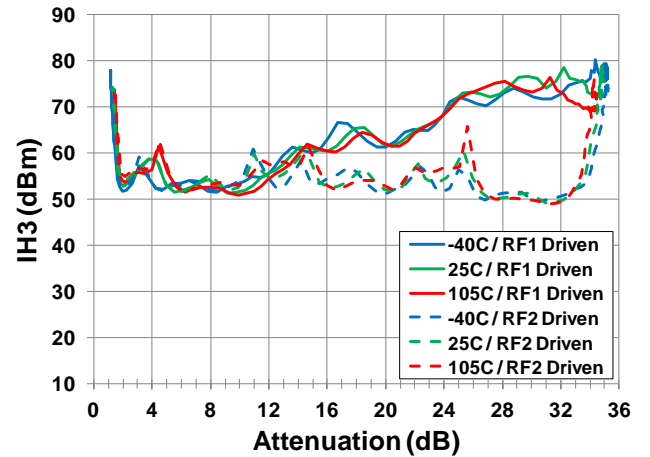

PACKAGE DRAWING (3MM X 3MM 16 PIN)



16-VFQFPN Package Outline Drawing

3.0 x 3.0 x 0.9 mm, 0.5mm Pitch, 1.70 x 1.70 mm Epad
NL/NLG16P2, PSC-4169-02, Rev 05, Page 1

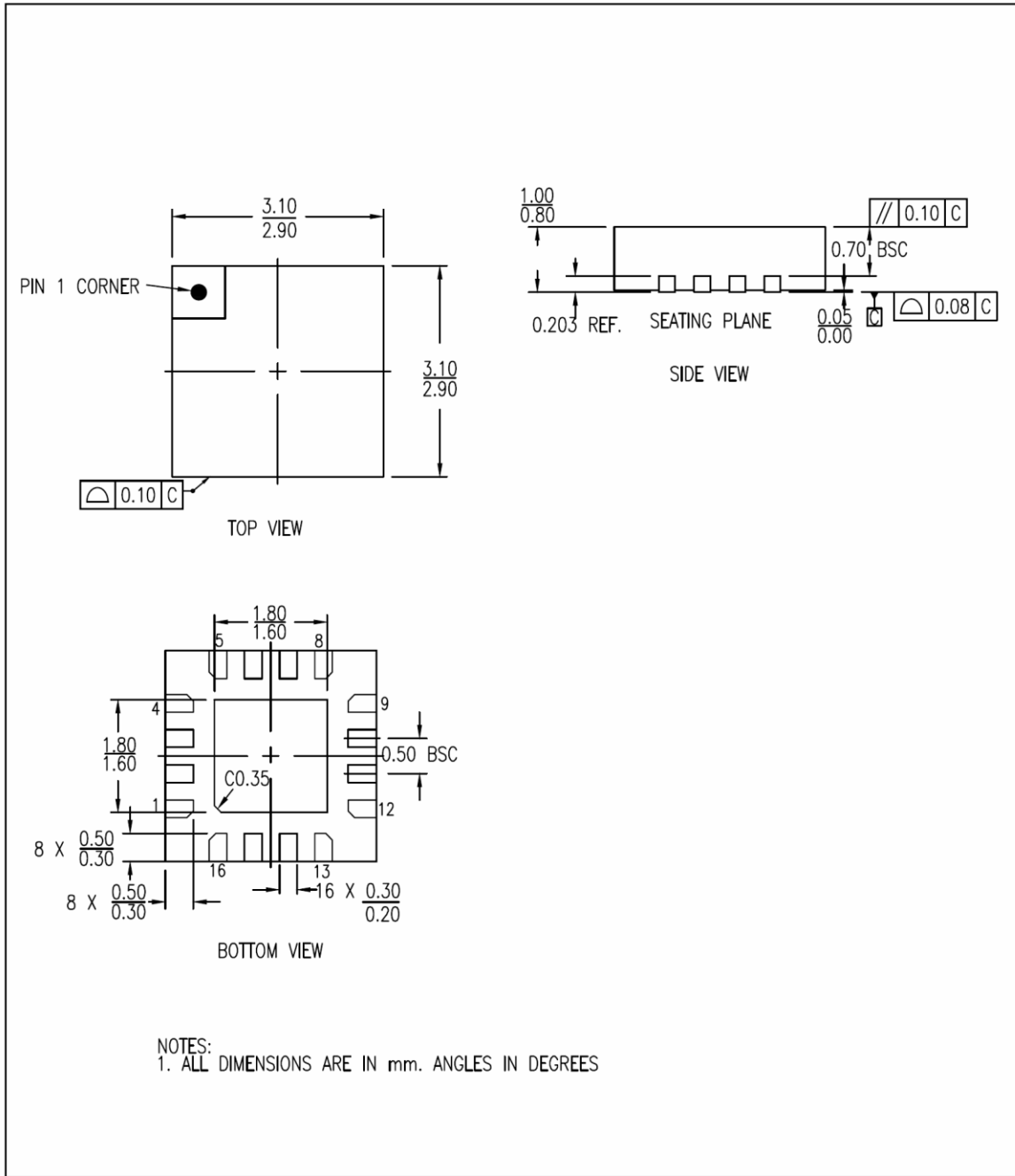

© Integrated Device Technology, Inc.

LAND PATTERN DRAWING



16-VFQFPN Package Outline Drawing

3.0 x 3.0 x 0.9 mm, 0.5mm Pitch, 1.70 x 1.70 mm Epad
 NL/NLG16P2, PSC-4169-02, Rev 05, Page 2

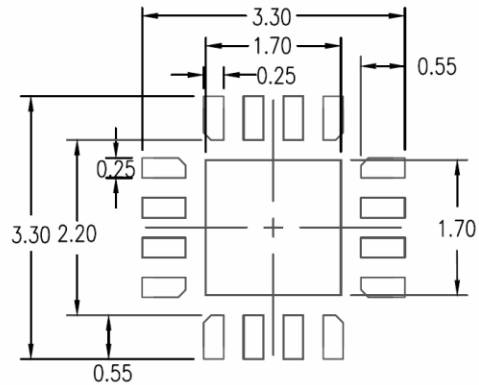

RECOMMENDED LAND PATTERN DIMENSION

NOTES:

1. ALL DIMENSIONS ARE IN mm. ANGLES IN DEGREES
2. TOP DOWN VIEW—AS VIEWED ON PCB
3. LAND PATTERN RECOMMENDATION IS PER IPC-7351B GENERIC REQUIREMENT FOR SURFACE MOUNT DESIGN AND LAND PATTERN

Package Revision History		
Date Created	Rev No.	Description
Oct 25, 2017	Rev 04	Remove Bookmak at Pdf Format & Update Thickness Tolerance
Jan 18, 2018	Rev 05	Change QFN to VFQFPN

© Integrated Device Technology, Inc.

PINOUT & BLOCK DIAGRAM

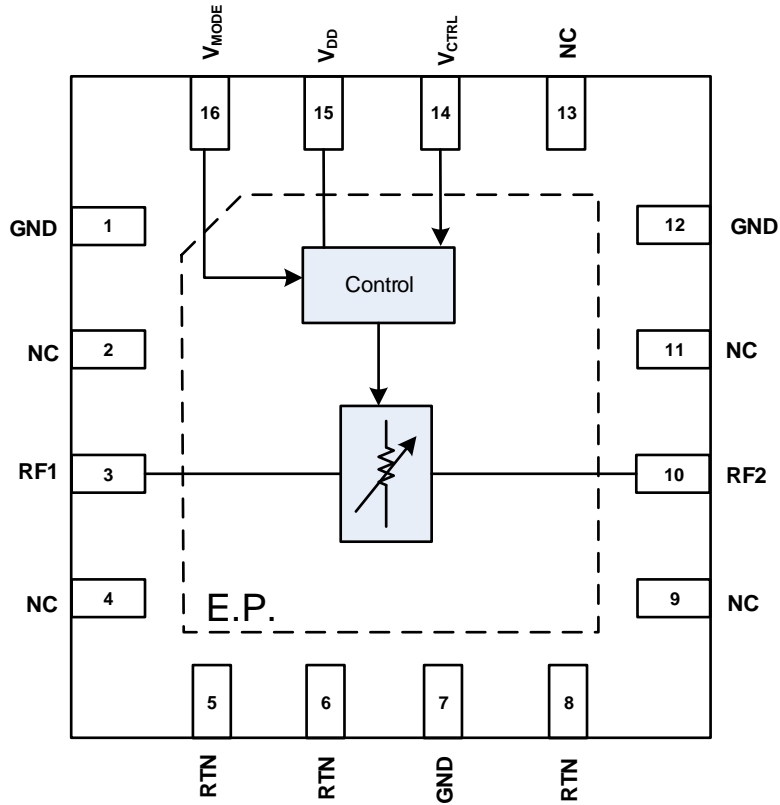

PIN DESCRIPTION

Pin	Name	Function
1, 7, 12	GND	Ground these pins as close to the device as possible.
2, 4, 9, 11, 13	NC	No internal connection. IDT recommends connecting these pins to GND.
3	RF1	RF Port 1. Matched to 50 ohms. Must use an external AC coupling capacitor as close to the device as possible. For low frequency operation increase the capacitor value to result in a low reactance at the frequency of interest.
5, 6, 8	RTN	Attenuator Ground Return. Each of these pins require a capacitor to GND to provide an RF return path. Place the capacitor as close to the device as possible.
10	RF2	RF Port 2. Matched to 50 ohms. Must use an external AC coupling capacitor as close to the device as possible. For low frequency operation increase the capacitor value to result in a low reactance at the frequency of interest.
14	V _{CTRL}	Attenuator control voltage. Apply a voltage in the range as specified in the Operating Conditions Table. See application section for details about V _{CTRL} .
15	V _{DD}	Power supply input. Bypass to GND with capacitors close as possible to pin.
16	V _{MODE}	Attenuator slope control. Set to logic LOW to enable negative attenuation slope. Set to logic HIGH to enable positive attenuation slope.
	— EP	Exposed Pad. Internally connected to GND. Solder this exposed pad to a PCB pad that uses multiple ground vias to achieve the specified RF performance.

APPLICATIONS INFORMATION

Default Start-up

V_{MODE} must be tied to either GND or Logic High. If the V_{CTRL} pin is left floating, the part will power up in the minimum attenuation state when $V_{MODE} = \text{GND}$, or the maximum attenuation state when $V_{MODE} = \text{High}$.

V_{CTRL}

The voltage level on the V_{CTRL} pin is used to control the attenuation of the F2255. At $V_{CTRL} = 0\text{V}$, the attenuation is a minimum (maximum) in the negative (positive) slope mode. An increasing (decreasing) voltage on V_{CTRL} produces an increasing (decreasing) attenuation respectively. The V_{CTRL} pin has an on-chip pull-up ESD diode so V_{DD} should be applied before V_{CTRL} is applied (see Recommended Operating Conditions for details). If this sequencing is not possible, then resistor R2 in the application circuit should be set to $1\text{k}\Omega$ to limit the current into the V_{CTRL} pin.

V_{MODE}

The V_{MODE} pin is used to set the slope of the attenuation. The attenuation is varied by V_{CTRL} as described in the next section. Setting V_{MODE} to a logic LOW (HIGH) will set the attenuation slope to negative (positive). A negative (positive) slope is defined as an increased (decreased) attenuation with increasing V_{CTRL} voltage. The Evaluation Kit provides an on-board jumper to manually set the V_{MODE} . Install a jumper on header J2 from V_{MODE} to the pin marked Lo (Hi) to set the device for a negative (positive) slope (see application circuit).

RF1 and RF2 Ports

The F2255 is a bi-directional device, allowing RF1 or RF2 to be used as the RF input. RF1 has some enhanced linearity performance, and therefore should be used as the RF input, when possible, for best results. The F2255 has been designed to accept high RF input power levels; therefore, V_{DD} must be applied prior to the application of RF power to ensure reliability. DC blocking capacitors are required on the RF pins and should be set to a value that results in a low reactance over the frequency range of interest.

Power Supplies

The supply pin should be bypassed with external capacitors to minimize noise and fast transients. Supply noise can degrade noise figure and fast transients can trigger ESD clamps and cause them to fail. Supply voltage change or transients should have a slew rate smaller than $1\text{V}/20\mu\text{s}$. In addition, all control pins should remain at 0V ($\pm 0.3\text{V}$) while the supply voltage ramps or while it returns to zero.

Control Pin Interface

If control signal integrity is a concern and clean signals cannot be guaranteed due to overshoot, undershoot, ringing, etc., the following circuit at the input of control pins 14 and 16 is recommended as shown below.

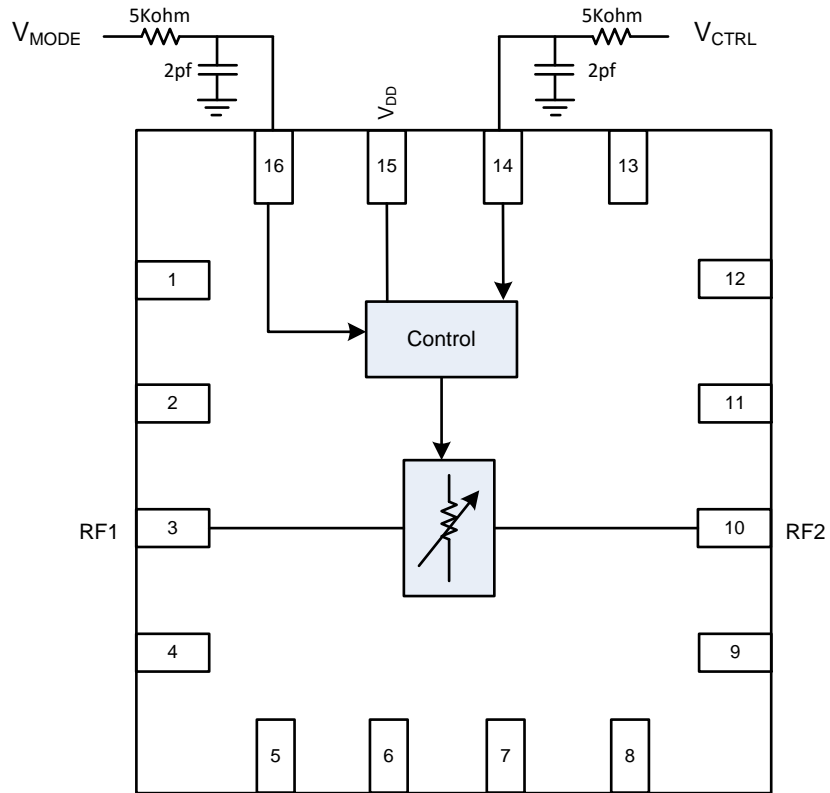

EVKIT / APPLICATIONS CIRCUIT

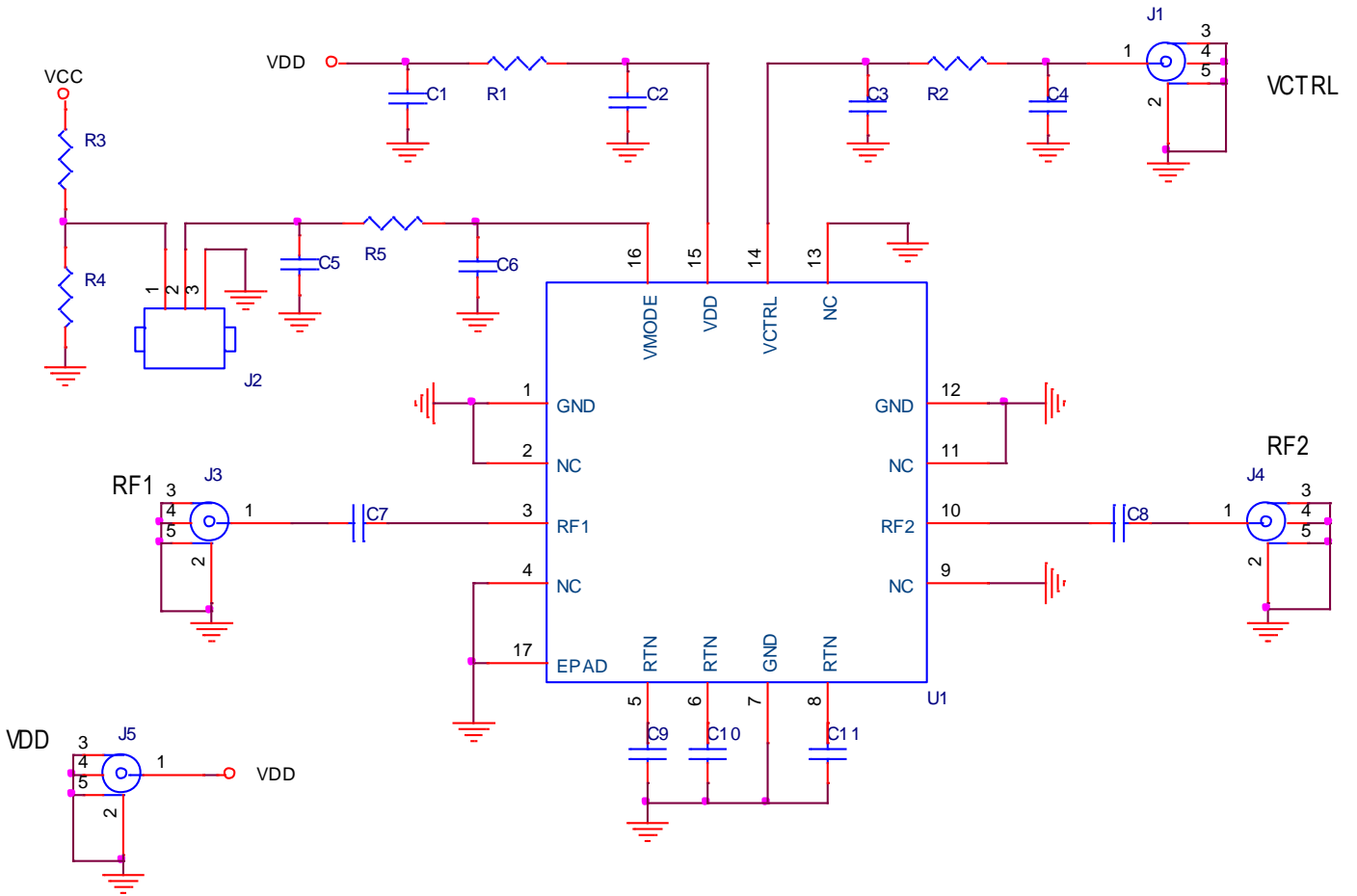

EVKIT PICTURE / LAYOUT (TOP VIEW)

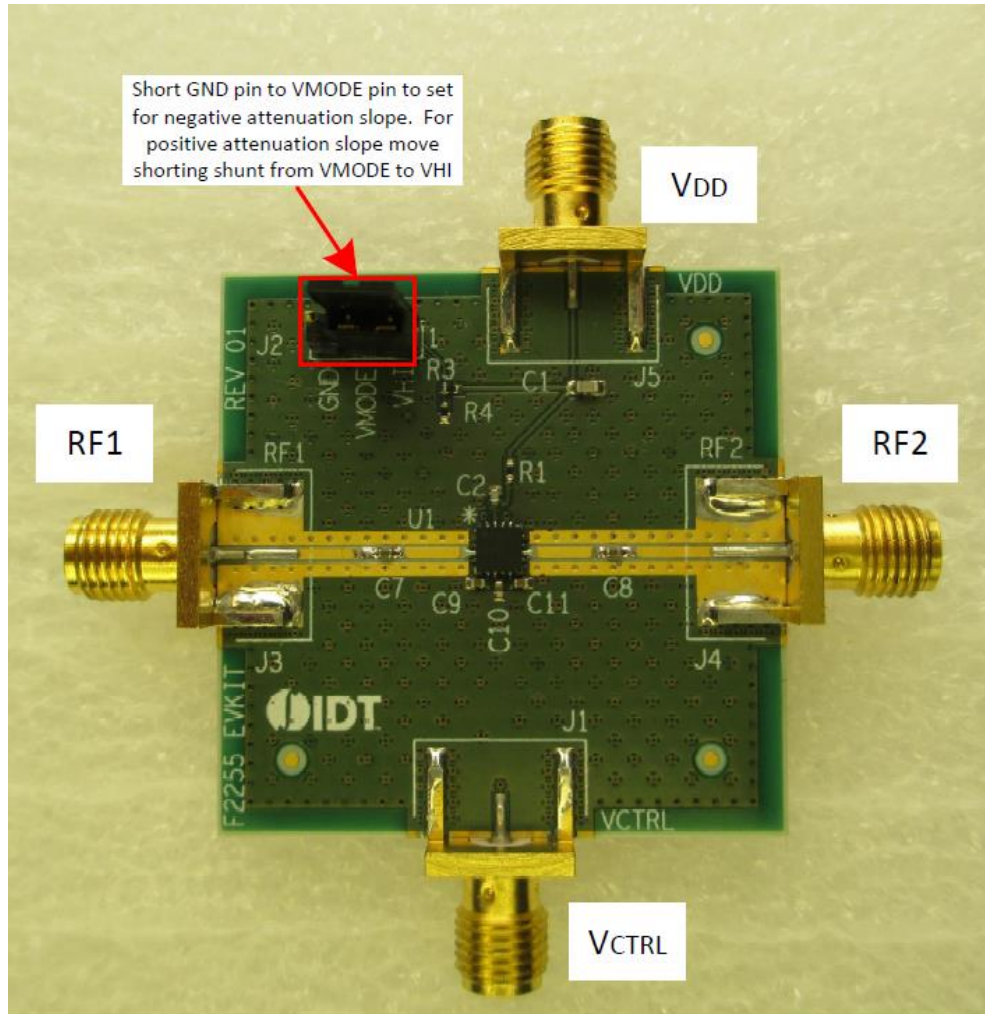

EVKIT PICTURE / LAYOUT (BOTTOM VIEW)

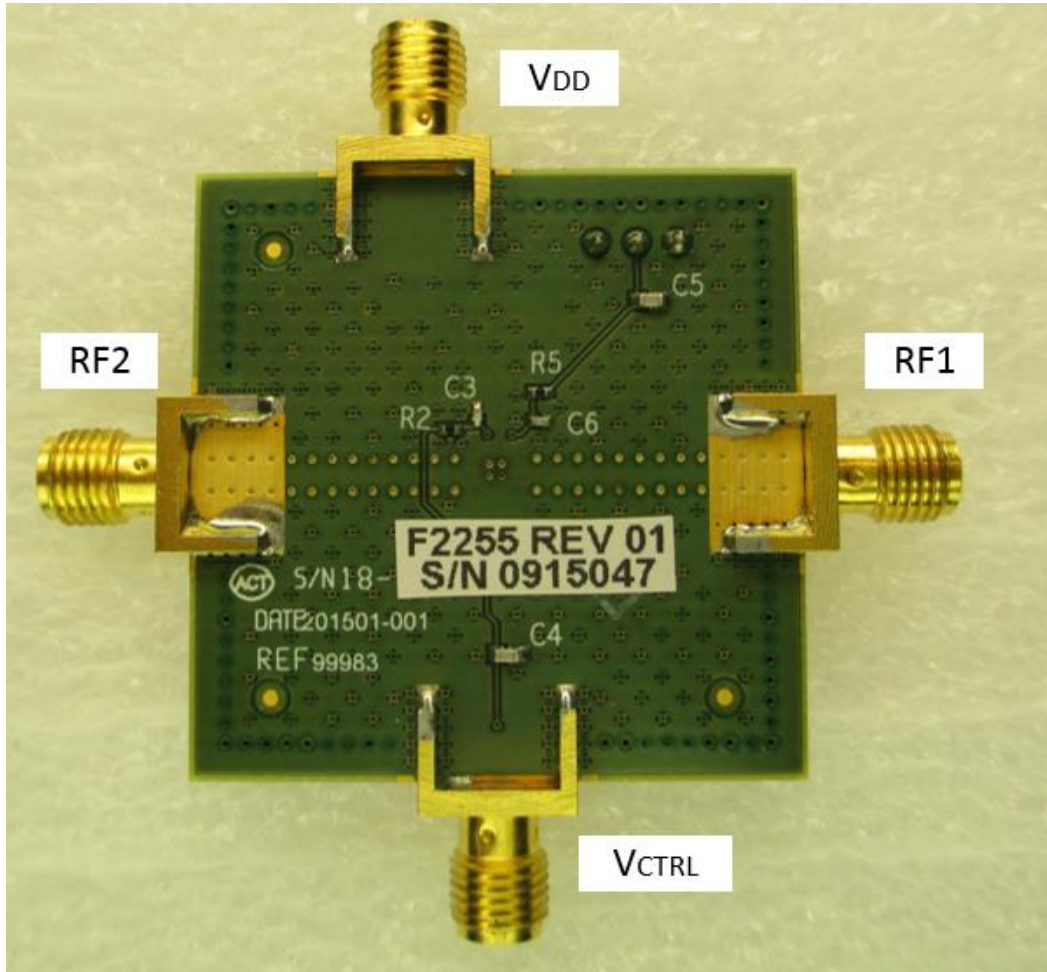

EVKIT BOM

Part Reference	QTY	DESCRIPTION	Mfr. Part #	Mfr.
C1, C4, C5	3	10nF ±5%, 50V, X7R Ceramic Capacitors (0603)	GRM188R71H103J	Murata
C2, C3, C6	3	1000pF ±5%, 50V, COG Ceramic Capacitors (0402)	GRM1555C1H102J	Murata
C7, C8, C9, C10, C11	5	100nF ±10%, 16V, X7R Ceramic Capacitors (0402)	GRM155R71C104K	Murata
R1, R2, R5	3	0Ω Resistors (0402)	ERJ-2GE0R00X	Panasonic
R3, R4	2	100kΩ ±1%, 1/10W, Resistors (0402)	ERJ-2RKF1003X	Panasonic
J1, J3, J4, J5	4	Edge Launch SMA (0.375 inch pitch ground tabs)	142-0701-851	Emerson Johnson
J2	1	CONN HEADER VERT SGL 3 X 1 POS GOLD	961103-6404-AR	3M
U1	1	Voltage Variable Attenuator	F2255NLGK	IDT
	1	Printed Circuit Board	F2255 REV 1	IDT

TOP MARKINGS

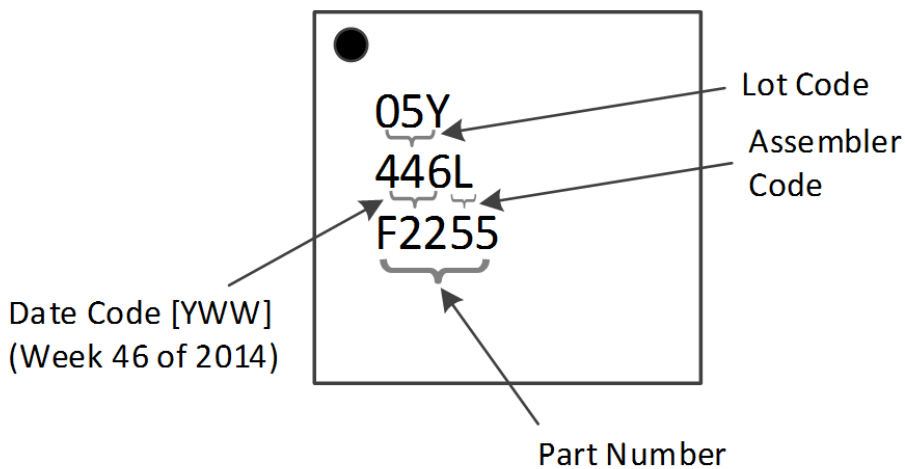

Revision History

Revision	Revision Date	Description of Change
2	February 9, 2018	Corrected POD drawing, added revision page
1	January 30, 2017	Updated GBT limits for I_{DD} , V_{MODE} and V_{CTRL}
0	November 5, 2015	Initial Release

IMPORTANT NOTICE AND DISCLAIMER

RENESAS ELECTRONICS CORPORATION AND ITS SUBSIDIARIES (“RENESAS”) PROVIDES TECHNICAL SPECIFICATIONS AND RELIABILITY DATA (INCLUDING DATASHEETS), DESIGN RESOURCES (INCLUDING REFERENCE DESIGNS), APPLICATION OR OTHER DESIGN ADVICE, WEB TOOLS, SAFETY INFORMATION, AND OTHER RESOURCES “AS IS” AND WITH ALL FAULTS, AND DISCLAIMS ALL WARRANTIES, EXPRESS OR IMPLIED, INCLUDING, WITHOUT LIMITATION, ANY IMPLIED WARRANTIES OF MERCHANTABILITY, FITNESS FOR A PARTICULAR PURPOSE, OR NON-INFRINGEMENT OF THIRD PARTY INTELLECTUAL PROPERTY RIGHTS.

These resources are intended for developers skilled in the art designing with Renesas products. You are solely responsible for (1) selecting the appropriate products for your application, (2) designing, validating, and testing your application, and (3) ensuring your application meets applicable standards, and any other safety, security, or other requirements. These resources are subject to change without notice. Renesas grants you permission to use these resources only for development of an application that uses Renesas products. Other reproduction or use of these resources is strictly prohibited. No license is granted to any other Renesas intellectual property or to any third party intellectual property. Renesas disclaims responsibility for, and you will fully indemnify Renesas and its representatives against, any claims, damages, costs, losses, or liabilities arising out of your use of these resources. Renesas' products are provided only subject to Renesas' Terms and Conditions of Sale or other applicable terms agreed to in writing. No use of any Renesas resources expands or otherwise alters any applicable warranties or warranty disclaimers for these products.

(Rev.1.0 Mar 2020)

Corporate Headquarters

TOYOSU FORESIA, 3-2-24 Toyosu,
Koto-ku, Tokyo 135-0061, Japan
www.renesas.com

Contact Information

For further information on a product, technology, the most up-to-date version of a document, or your nearest sales office, please visit:
www.renesas.com/contact/

Trademarks

Renesas and the Renesas logo are trademarks of Renesas Electronics Corporation. All trademarks and registered trademarks are the property of their respective owners.