

Features

- 100% avalanche tested
- Avalanche ruggedness
- Gate charge minimized
- Very low intrinsic capacitances
- High speed switching
- Very low on-resistance

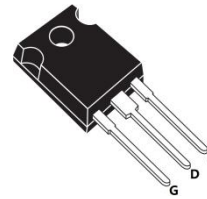

General Description

Applications

- Welder
- UPS
- PV Inverter
- Switching applications

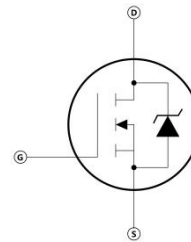

Electrical ratings

Absolute maximum ratings			
Parameter	Symbol	Value	Unit
Drain-source voltage ($V_{GS} = 0$)	V_{DS}	1500	V
Gate- source voltage	V_{GS}	± 30	
Drain current (continuous) at $T_C = 25\text{ }^\circ\text{C}$	I_D	9	A
Drain current (continuous) at $T_C = 100\text{ }^\circ\text{C}$		6	
Drain current (pulsed)		I_{DM}	
Total dissipation at $T_C = 25\text{ }^\circ\text{C}$	P_{TOT}	350	W
Derating factor		2.56	W/ $^\circ\text{C}$
Operating junction temperature	T_J	-55 to 150	$^\circ\text{C}$
Storage temperature	T_{stg}		

Thermal data			
Parameter	Symbol	Value	Unit
Thermal resistance junction-case max	$R_{thj-case}$	0.39	W/ $^\circ\text{C}$
Thermal resistance junction-ambient max	$R_{thj-amb}$	50	
Maximum lead temperature for soldering purpose	T_J	300	

Avalanche characteristics			
Parameter	Symbol	Max value	Unit
Avalanche current, repetitive or not-repetitive (pulse width limited by T_J max)	I_{AR}	8	A
Single pulse avalanche energy (starting $T_J = 25\text{ }^\circ\text{C}$, $I_D = I_{AR}$, $V_{DD} = 50\text{ V}$)	E_{AS}	800	mJ

Electrical Characteristics ($T_{vj} = 25^\circ\text{C}$ unless otherwise specified)

On /off states						
Parameter	Symbol	Test conditions	Min	Typ	Max	Unit
Drain-source breakdown voltage	$V_{(BR)DSS}$	$I_D = 1\text{ mA}$, $V_{GS} = 0$	1500			V
Zero gate voltage drain current ($V_{GS} = 0$)	I_{DSS}	$V_{DS} = \text{Max rating}$ $V_{DS} = \text{Max rating}$, $T_C = 125\text{ }^\circ\text{C}$			10 500	μA
Gate-body leakage current ($V_{DS} = 0$)	I_{GSS}	$V_{GS} = \pm 30\text{ V}$			± 100	nA
Gate threshold voltage	$V_{GS(th)}$	$V_{DS} = V_{GS}$, $I_D = 250\text{ }\mu\text{A}$	3	4	5	V
Static drain-source on resistance	$R_{DS(on)}$	$V_{GS} = 10\text{ V}$, $I_D = 4\text{ A}$	-	2.9	3.5	Ω

Dynamic						
Parameter	Symbol	Test conditions	Min	Typ	Max	Unit
Forward transconductance	g_{fs}	$V_{DS} = 15\text{ V}$, $I_D = 4$		7		S
Input capacitance	C_{iss}	$V_{DS} = 25\text{ V}$, $f = 1\text{ MHz}$, $V_{GS} = 0$		3150		pF
Output capacitance	C_{oss}			300		
Reverse transfer capacitance	C_{rss}			25		
Equivalent Output capacitance	$C_{oss\text{ eq.}}$	$V_{GS} = 0$, $V_{DS} = 0$ to 1200 V		120		
Gate input resistance	R_g	$f = 1\text{ MHz}$ Gate DC Bias = 0 Test signal level = 20mV open drain		2.2		Ω
Total gate charge	Q_g	$V_{DD} = 1200\text{ V}$, $I_D = 8\text{ A}$ $V_{GS} = 10\text{ V}$		85		nC
Gate-source charge	Q_{gs}			14		
Gate-drain charge	Q_{gd}			48		

Switching times						
Parameter	Symbol	Test conditions	Min	Typ	Max	Unit
Turn-on delay time	$t_{d(on)}$	$V_{DD} = 750 \text{ V}, I_D = 4 \text{ A},$ $R_G = 4.7 \Omega, V_{GS} = 10 \text{ V}$		50		ns
Rise time	t_r			16		
Turn-off-delay time	$t_{d(off)}$			100		
Fall time	t_f			80		

Source drain diode						
Parameter	Symbol	Test conditions	Min	Typ	Max	Unit
Source-drain current	I_{SD}			8		A
Source-drain current (pulsed)	I_{SDM}			40		
Forward on voltage	V_{SD}	$I_{SD} = 8 \text{ A}, V_{GS} = 0$		1.5		V
Reverse recovery time	t_{rr}	$I_{SD} = 8 \text{ A}, di/dt = 100 \text{ A}/\mu\text{s}$ $V_{DD} = 60 \text{ V}$		950		
Reverse recovery charge	Q_{rr}			9		
Reverse recovery current	I_{RRM}			20		
Reverse recovery time	t_{rr}	$S_D = 8 \text{ A}, di/dt = 100 \text{ A}/\mu\text{s}$ $V_{DD} = 60 \text{ V}, T_J = 150^\circ\text{C}$		900		
Reverse recovery charge	Q_{rr}			8.5		
Reverse recovery current	I_{RRM}			19		

Electrical characteristics

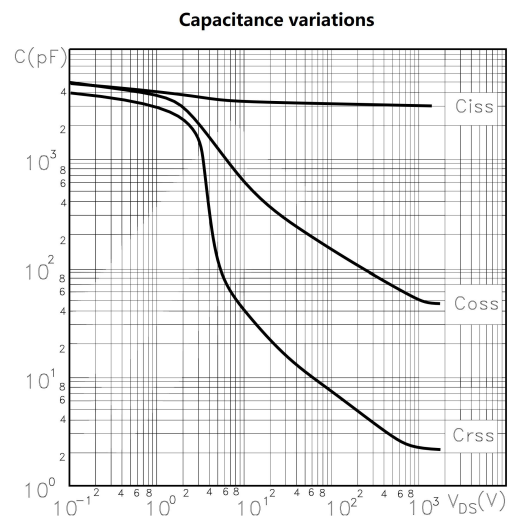
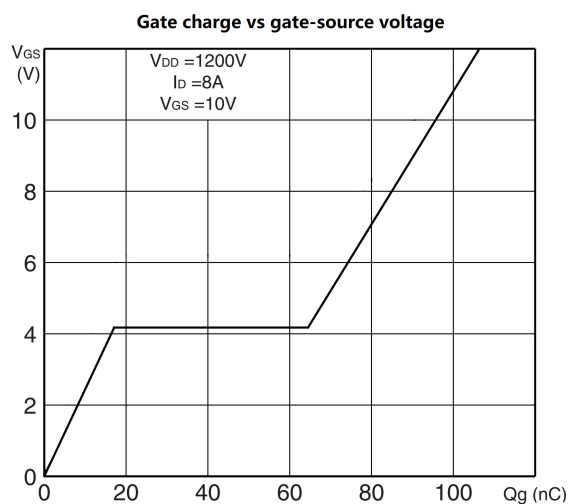

Normalized BVDSS vs temperature

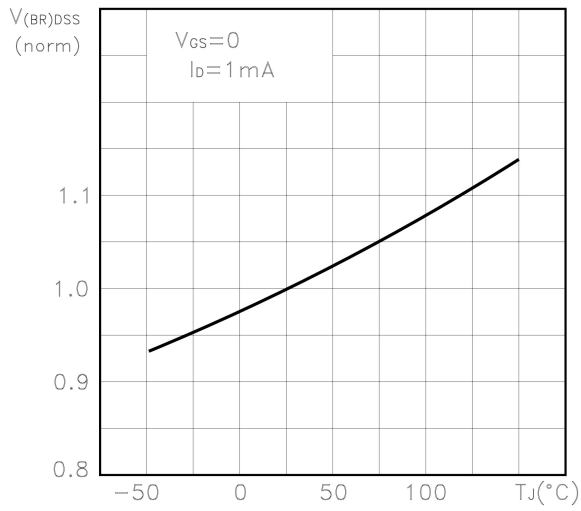

Static drain-source on resistance

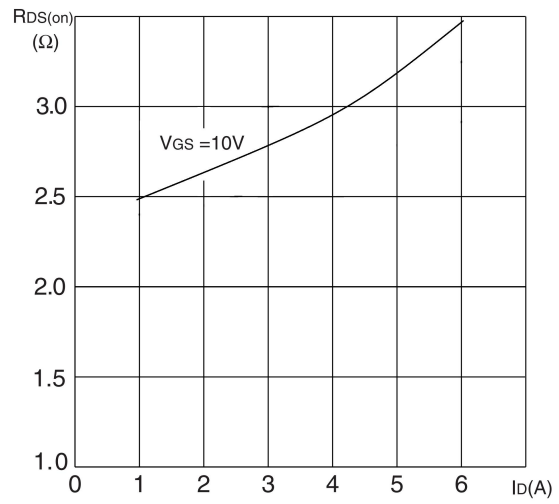

Output characteristics

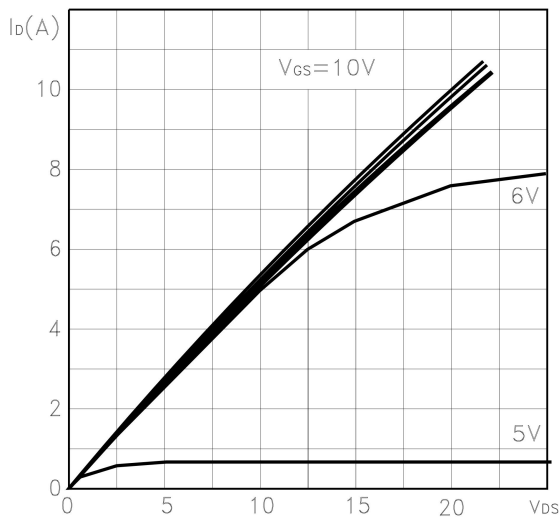

Transfer characteristics

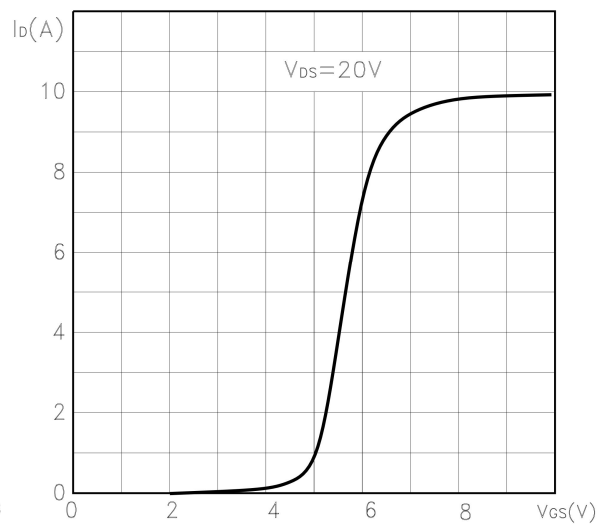

Normalized gate threshold voltage vs temperature

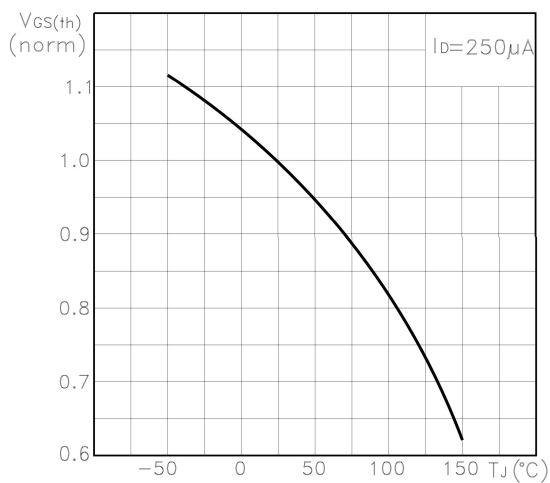

Normalized on resistance vs temperature

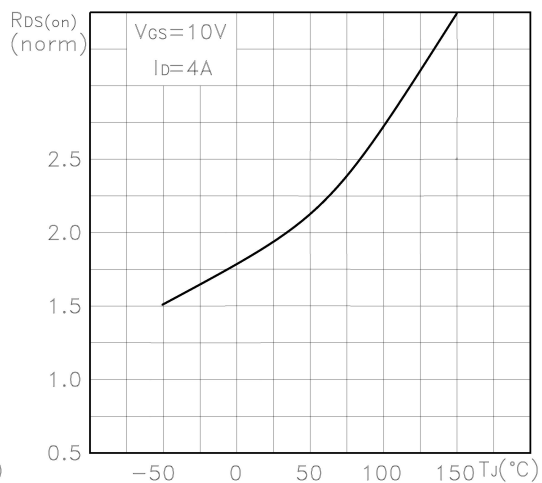

Gate charge vs gate-source voltage

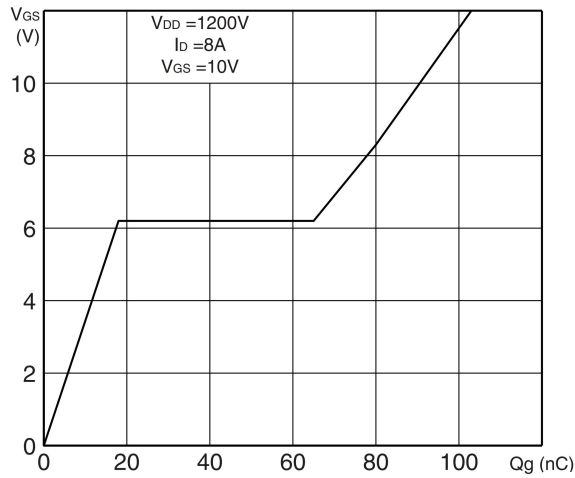

Capacitance variations

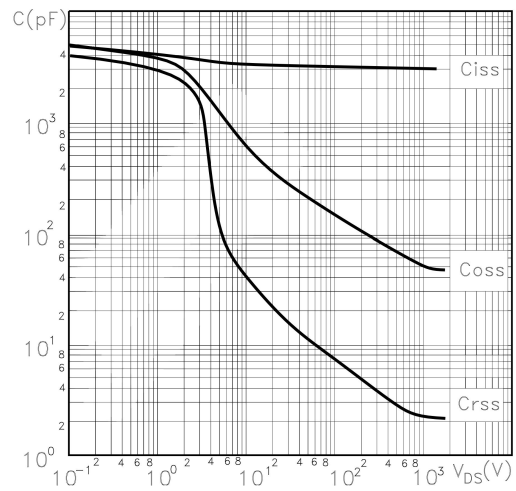

Source-drain diode forward characteristics

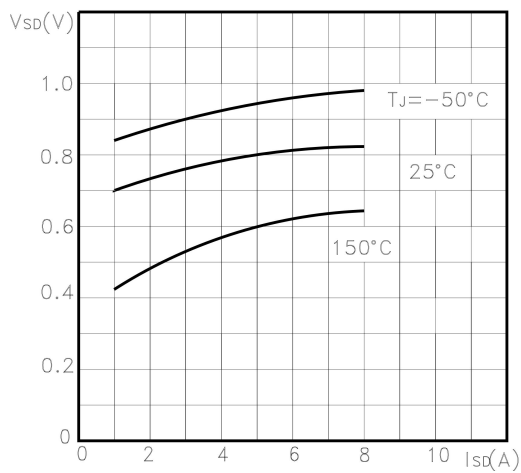

Maximum avalanche energy vs temperature

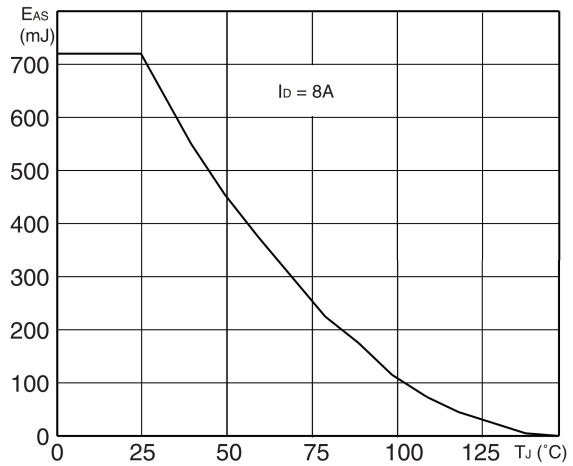

Safe operating area

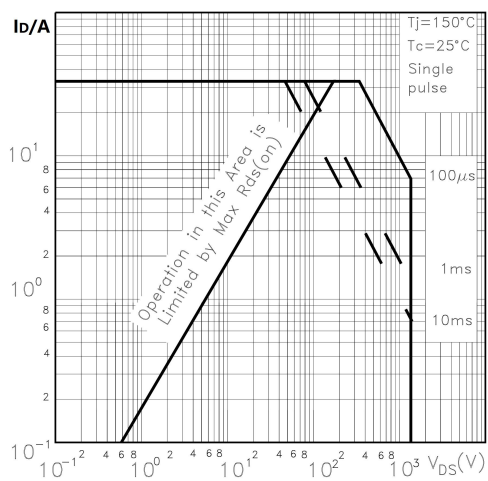

Thermal impedance

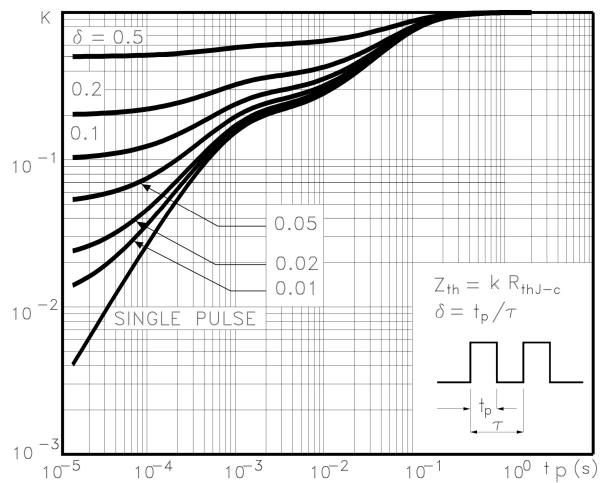

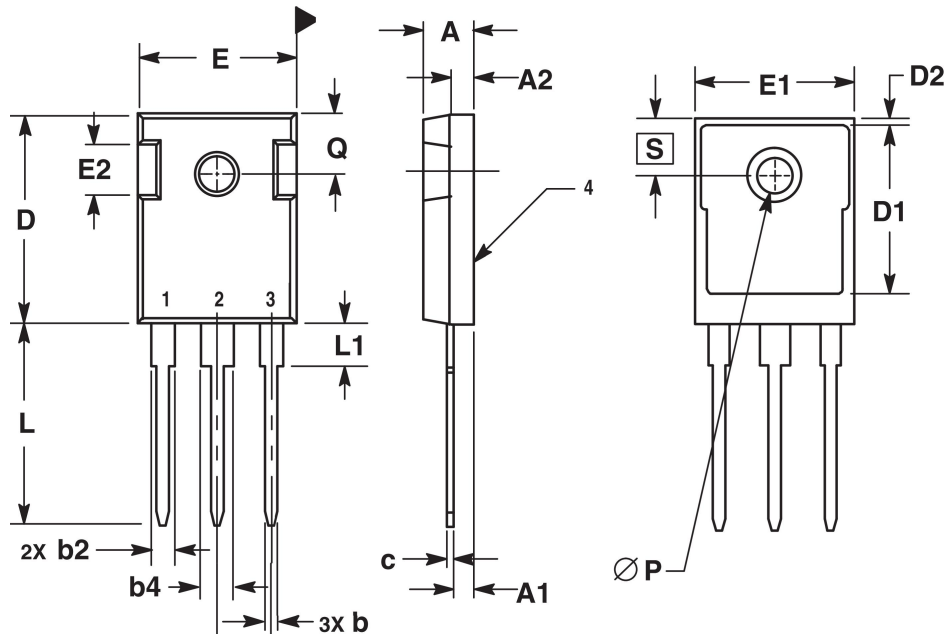
Package outline dimension
TO-247

Symbol	Min	Max	Unit
A	4.7	5.31	mm
A1	2.21	2.59	
A2	1.5	2.49	
b	1	1.4	
b2	1.65	2.39	
b4	2.59	3.43	
c	0.38	0.89	
D	20.8	21.46	
D1	13.08	-	
D2	0.51	1.35	
E	15.49	16.26	
E1	13.46	-	
E2	4.32	5.49	
e	5.46BSC		
L	19.81	20.32	
L1	-	4.5	
P	3.56	3.66	
Q	5.38	6.2	
S	6.15BSC		