

## FEATURES

- FLAT PLATE POWER INDUCTOR
- SMALL SIZE WITH CURRENT RATINGS TO 19 AMPS
- SURFACE MOUNTABLE CONSTRUCTION
- HIGH INDUCTANCE (UP TO 10 $\mu$ H)
- TAPED AND REELED FOR AUTOMATIC INSERTION
- FOR USE IN DC/DC CONVERTERS

**RoHS  
Compliant**  
includes all homogeneous materials

\*See Part Number System for Details

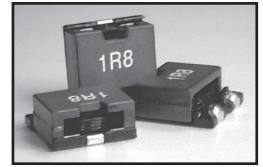

## CHARACTERISTICS

Case Size	NPIF104C	NPIF105C	NPIF125C	NPIF134C
Inductance Range	0.22 ~ 8.8 $\mu$ H	0.15 ~ 8.8 $\mu$ H	1.5 ~ 10 $\mu$ H	0.30 ~ 8.0 $\mu$ H
Ambient Operating Temperature Range	-40°C ~ +85°C			
Maximum Component Temperature (Ambient + Self-Heating)	+125°C			
Temperature Rise at IDC	+40°C max.			
Inductance Change at IDC	-30% typical			
Inductance Tolerance	$\pm$ 20% (M) and $\pm$ 30%(Y)			
Resistance to Solder Heat	260°C for 10 seconds			

## DIMENSIONS (mm)

Series	A max.	B max.	C max.	D	E	F	G	H	I	J	K
NPIF104C	10.4	10.4	4.5	6.7	2.6	5.5	1.4	2.0	2.5	8.5	11.0
NPIF105C			5.6								
NPIF125C	12.9	12.9	5.7	8.2		7.0	2.5	3.0	4.0	10.0	13.5
NPIF134C	13.9	13.9	5.0	9.6		7.2	2.6	4.4	15.0		

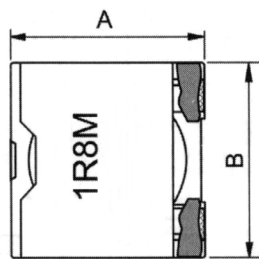

TOP VIEW

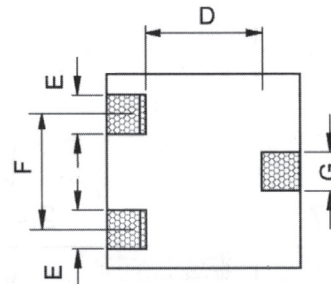
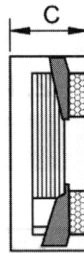

BOTTOM VIEW

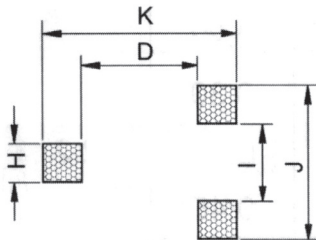

LAND PATTERN

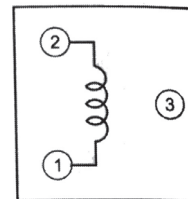

SCHEMATIC

## PART NUMBER SYSTEM

NPIF 104 C 151 M L TR F

- Termination Finish:  
F = Standard Pb-free (100%Sn)
- Packaging: TR = Tape & Reel
- Current Rating Identifier
- Inductance Tolerance Code: M= $\pm$ 20%, Y= $\pm$ 30%
- Inductance Code ( $\mu$ H): 1st two digits are significant, 3rd digit is multiplier.
- Construction Code (see drawing for details)
- Size Code (see table for details)
- Series



Part Number	STANDARD VALUES - CASE SIZE 104 (10.4 x 10.4 x 4.5mm)			Test Frequency
	Inductance Value (μH)	DC Resistance (mΩ)	DC Current Isat/Irms (Amps)	
NPIF104CR22YSTRF	0.22 ± 30%	2.2	18.0	100KHz
NPIF104CR36YLTRF	0.36 ± 30%	2.2	18.0	
NPIF104CR45MSTRF	0.45 ± 20%	3.7	13.4	
NPIF104CR80MLTRF	0.80 ± 20%	3.7	13.4	
NPIF104CR80MSTRF	0.80 ± 20%	5.9	10.2	
NPIF104C1R3MSTRF	1.3 ± 20%	11.8	7.3	
NPIF104C1R4MLTRF	1.4 ± 20%	5.9	10.2	
NPIF104C1R8MSTRF	1.8 ± 20%	18.6	5.4	
NPIF104C2R2MLTRF	2.2 ± 20%	11.8	7.3	
NPIF104C2R5MSTRF	2.5 ± 20%	21.8	5.0	
NPIF104C3R2MLTRF	3.2 ± 20%	18.6	5.4	
NPIF104C4R3MLTRF	4.3 ± 20%	21.8	5.0	

Maximum +40°C temperature rise at Irms. Typical -30% inductance change at Isat.

Part Number	STANDARD VALUES - CASE SIZE 105 (10.4 x 10.4 x 5.6mm)			Test Frequency
	Inductance Value (μH)	DC Resistance (mΩ)	DC Current Isat/Irms (Amps)	
NPIF105CR15YHTRF	0.15 ± 30%	1.7	19.0	100KHz
NPIF105CR22YSTRF	0.22 ± 30%	1.7	19.0	
NPIF105CR30YHTRF	0.30 ± 30%	2.4	17.7	
NPIF105CR36YLTRF	0.36 ± 30%	1.7	19.0	
NPIF105CR45MSTRF	0.45 ± 20%	2.4	17.7	
NPIF105CR50MHTRF	0.50 ± 20%	4.1	13.0	
NPIF105CR80MLTRF	0.80 ± 20%	2.4	16.0	
NPIF105CR80MSTRF	0.80 ± 20%	4.1	13.0	
NPIF105CR80MHTRF	0.80 ± 20%	5.3	11.2	
NPIF105C1R2MHTRF	1.2 ± 20%	7.5	9.0	
NPIF105C1R3MSTRF	1.3 ± 20%	5.3	11.2	
NPIF105C1R4MLTRF	1.4 ± 20%	4.1	12.0	
NPIF105C1R5MHTRF	1.5 ± 20%	10.5	7.8	
NPIF105C1R8MSTRF	1.8 ± 20%	7.5	9.0	
NPIF105C2R0MHTRF	2.0 ± 20%	12.4	7.4	
NPIF105C2R2MLTRF	2.2 ± 20%	5.3	9.6	
NPIF105C2R5MSTRF	2.5 ± 20%	10.5	7.8	
NPIF105C3R0MHTRF	3.0 ± 20%	23.8	4.9	
NPIF105C3R2MLTRF	3.2 ± 20%	7.5	7.8	
NPIF105C3R2MSTRF	3.2 ± 20%	12.4	7.4	
NPIF105C4R0MSTRF	4.0 ± 20%	18	6.2	
NPIF105C4R3MLTRF	4.3 ± 20%	10.5	6.8	
NPIF105C5R0MSTRF	5.0 ± 20%	23.8	4.9	
NPIF105C5R7MLTRF	5.7 ± 20%	12.4	5.8	
NPIF105C7R2MLTRF	7.2 ± 20%	18.0	5.3	
NPIF105C8R8MLTRF	8.8 ± 20%	23.8	4.8	

Maximum +40°C temperature rise at Irms. Typical -30% inductance change at Isat.

Part Number	STANDARD VALUES - CASE SIZE 125 (12.9 x 12.9 x 5.7mm)			Test Frequency
	Inductance Value (μH)	DC Resistance (mΩ)	DC Current Isat/Irms (Amps)	
NPIF125CR35YUTRF	0.35 ± 30%	1.8	18.5	100KHz
NPIF125CR80YUTRF	0.80 ± 30%	2.5	16.5	
NPIF125C1R0MHTRF	1.0 ± 20%	2.5	16.5	
NPIF125C1R4MUTRF	1.4 ± 20%	3.4	15.5	
NPIF125C1R5MTRF	1.5 ± 20%	2.5	14.0	
NPIF125C1R8MHTRF	1.8 ± 20%	3.4	15.3	
NPIF125C2R2MUTRF	2.2 ± 20%	5.4	12.5	
NPIF125C2R5MTRF	2.5 ± 20%	3.4	10.0	
NPIF125C2R8MHTRF	2.8 ± 20%	5.4	12.3	
NPIF125C3R2MUTRF	3.2 ± 20%	8.0	9.9	
NPIF125C4R0MTRF	4.0 ± 20%	8.0	8.3	
NPIF125C4R0MHTRF	4.0 ± 20%	8.0	9.9	
NPIF125C4R3MUTRF	4.3 ± 20%	11.4	8.2	
NPIF125C5R6MHTRF	5.6 ± 20%	11.4	8.2	
NPIF125C5R6MUTRF	5.6 ± 20%	13.5	7.6	
NPIF125C6R0MTRF	6.0 ± 20%	8.0	6.7	
NPIF125C7R2MHTRF	7.2 ± 20%	13.5	7.6	
NPIF125C8R2MTRF	8.2 ± 20%	11.4	5.8	
NPIF125C100MTRF	10 ± 20%	13.5	5.0	

Maximum +40°C temperature rise at Irms. Typical -30% inductance change at Isat.

Part Number	STANDARD VALUES - CASE SIZE 134 (13.9 x 13.9 x 5.0mm)			Test Frequency
	Inductance Value (μH)	DC Resistance (mΩ)	DC Current Isat/Irms (Amps)	
NPIF134CR30YHTRF	0.30 ± 30%	1.9	18.5	100KHz
NPIF134CR40YTRF	0.40 ± 30%	1.9	18.5	
NPIF134CR66MHTRF	0.66 ± 20%	2.5	17.0	
NPIF134CR90MTRF	0.90 ± 20%	2.5	17.0	
NPIF134C1R2MHTRF	1.2 ± 20%	3.7	15.0	
NPIF134C1R6MTRF	1.6 ± 20%	3.7	15.0	
NPIF134C1R8MHTRF	1.8 ± 20%	6.6	10.5	
NPIF134C2R5MTRF	2.5 ± 20%	6.6	10.5	
NPIF134C2R7MHTRF	2.7 ± 20%	10.8	8.0	
NPIF134C3R6MTRF	3.6 ± 20%	10.8	8.0	
NPIF134C3R6MHTRF	3.6 ± 20%	12.0	7.5	
NPIF134C4R8MTRF	4.8 ± 20%	12.0	7.5	
NPIF134C4R8MHTRF	4.8 ± 20%	16.3	7.0	
NPIF134C6R0MHTRF	6.0 ± 20%	18.4	6.5	
NPIF134C6R4MTRF	6.4 ± 20%	16.3	7.0	
NPIF134C8R0MTRF	8.0 ± 20%	18.4	6.5	

Maximum +40°C temperature rise at Irms. Typical -30% inductance change at Isat.

### RECOMMENDED LAND PATTERN DIMENSIONS

Series	D	H	I	J	K
NPIF104C	6.7	2.0	2.5	8.5	11.0
NPIF105C	6.7	2.0	2.5	8.5	11.0
NPIF125C	8.2	3.0	4.0	10.0	13.5
NPIF134C	9.6	2.6	4.4	10	15.0

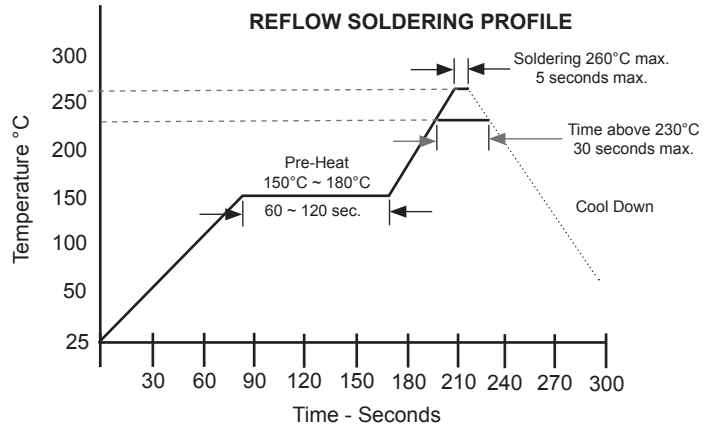
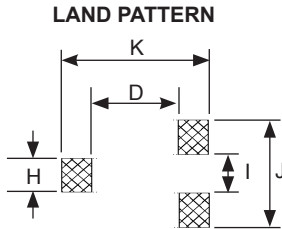

Case Size	TAPING DIMENSIONS (mm)				
	A	B	P	W	Qty/Reel
NPIF104C	10.4 ± 0.1	10.4 ± 0.1	16.0	24.0	500 pcs
NPIF105C	10.4 ± 0.1	10.4 ± 0.1	16.0	24.0	500 pcs
NPIF125C	13.0 ± 0.1	13.0 ± 0.1	16.0	24.0	500 pcs
NPIF134C	13.9 ± 0.1	13.9 ± 0.1	16.0	24.0	500 pcs

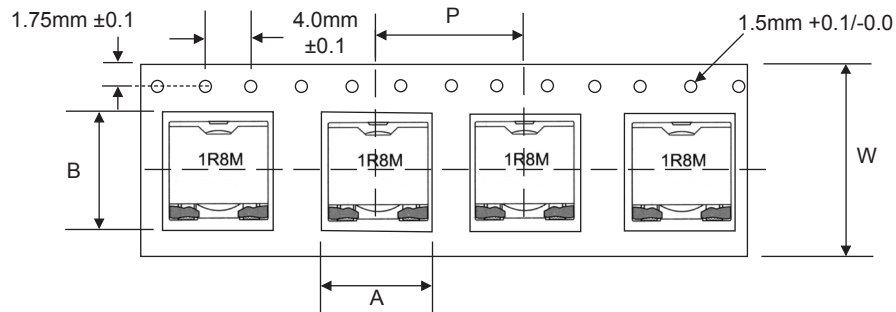

Tape Width	REEL DIMENSIONS (mm)			
	A(mm)	B(mm)	C(mm)	D(mm)
16mm	16.5 ± 0.1	23 ± 1.0	13 ± 1.0	330

