

High Speed PT IGBT

POWER MOS 8® is a high speed Punch-Through switch-mode IGBT. Low E_{off} is achieved through leading technology silicon design and lifetime control processes. A reduced $E_{off} - V_{CE(ON)}$ tradeoff results in superior efficiency compared to other IGBT technologies. Low gate charge and a greatly reduced ratio of C_{res}/C_{ies} provide excellent noise immunity, short delay times and simple gate drive. The intrinsic chip gate resistance and capacitance of the poly-silicone gate structure help control di/dt during switching, resulting in low EMI, even when switching at high frequency.

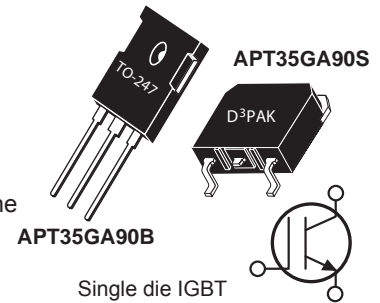

FEATURES

- Fast switching with low EMI
- Very Low E_{off} for maximum efficiency
- Ultra low C_{res} for improved noise immunity
- Low conduction loss
- Low gate charge
- Increased intrinsic gate resistance for low EMI
- RoHS compliant 

TYPICAL APPLICATIONS

- ZVS phase shifted and other full bridge
- Half bridge
- High power PFC boost
- Welding
- UPS, solar, and other inverters
- High frequency, high efficiency industrial

Absolute Maximum Ratings

Symbol	Parameter	Ratings	Unit
V_{ces}	Collector Emitter Voltage	900	V
I_{C1}	Continuous Collector Current @ $T_c = 25^\circ\text{C}$	63	A
I_{C2}	Continuous Collector Current @ $T_c = 100^\circ\text{C}$	35	
I_{CM}	Pulsed Collector Current ¹	105	
V_{GE}	Gate-Emitter Voltage ²	±30	V
P_D	Total Power Dissipation @ $T_c = 25^\circ\text{C}$	290	W
SSOA	Switching Safe Operating Area @ $T_j = 150^\circ\text{C}$	105A @ 900V	
T_J, T_{STG}	Operating and Storage Junction Temperature Range	-55 to 150	°C
T_J	Lead Temperature for Soldering: 0.063" from Case for 10 Seconds	300	

Static Characteristics

$T_J = 25^\circ\text{C}$ unless otherwise specified

Symbol	Parameter	Test Conditions	Min	Typ	Max	Unit
$V_{BR(CE)}$	Collector-Emitter Breakdown Voltage	$V_{GE} = 0V, I_C = 1.0mA$	900			V
$V_{CE(on)}$	Collector-Emitter On Voltage	$V_{GE} = 15V, I_C = 18A$		2.5	3.1	
		$T_J = 25^\circ\text{C}$ $T_J = 125^\circ\text{C}$		2.2		
$V_{GE(th)}$	Gate Emitter Threshold Voltage	$V_{GE} = V_{CE}, I_C = 1mA$	3	4.5	6	
I_{CES}	Zero Gate Voltage Collector Current	$V_{CE} = 900V, V_{GE} = 0V$			250	µA
		$T_J = 25^\circ\text{C}$ $T_J = 125^\circ\text{C}$			1000	
I_{GES}	Gate-Emitter Leakage Current	$V_{GS} = \pm 30V$			±100	nA

Thermal and Mechanical Characteristics

Symbol	Characteristic	Min	Typ	Max	Unit
$R_{\theta JC}$	Junction to Case Thermal Resistance	-	-	0.43	°C/W
W_T	Package Weight	-	5.9	-	g
Torque	Mounting Torque (TO-247 Package), 4-40 or M3 screw			10	in·lbf

Dynamic Characteristics

T_J = 25°C unless otherwise specified

APT35GA90B_S

Symbol	Parameter	Test Conditions	Min	Typ	Max	Unit	
C _{ies}	Input Capacitance	Capacitance V _{GE} = 0V, V _{CE} = 25V f = 1MHz		1934		pF	
C _{oes}	Output Capacitance			173			
C _{res}	Reverse Transfer Capacitance			28			
Q _g ³	Total Gate Charge	Gate Charge V _{GE} = 15V V _{CE} = 450V I _C = 18A		84		nC	
Q _{ge}	Gate-Emitter Charge			14			
Q _{gc}	Gate- Collector Charge			34			
SSOA	Switching Safe Operating Area	T _J = 150°C, R _G = 10Ω ⁴ , V _{GE} = 15V, L = 100uH, V _{CE} = 900V	105			A	
t _{d(on)}	Turn-On Delay Time	Inductive Switching (25°C) V _{CC} = 600V V _{GE} = 15V I _C = 18A R _G = 10Ω ⁴ T _J = +25°C		12		ns	
t _r	Current Rise Time			15			
t _{d(off)}	Turn-Off Delay Time			104			
t _f	Current Fall Time			86			
E _{on2}	Turn-On Switching Energy				642		μJ
E _{off} ⁶	Turn-Off Switching Energy				382		
t _{d(on)}	Turn-On Delay Time	Inductive Switching (125°C) V _{CC} = 600V V _{GE} = 15V I _C = 18A R _G = 10Ω ⁴ T _J = +125°C		11		ns	
t _r	Current Rise Time			14			
t _{d(off)}	Turn-Off Delay Time			154			
t _f	Current Fall Time			144			
E _{on2}	Turn-On Switching Energy				1044		μJ
E _{off} ⁶	Turn-Off Switching Energy				907		

1 Repetitive Rating: Pulse width and case temperature limited by maximum junction temperature.

2 Pulse test: Pulse Width < 380μs, duty cycle < 2%.

3 See Mil-Std-750 Method 3471.

4 R_G is external gate resistance, not including internal gate resistance or gate driver impedance. (MIC4452)

5 E_{on2} is the clamped inductive turn on energy that includes a commutating diode reverse recovery current in the IGBT turn on energy loss. A combi device is used for the clamping diode.

6 E_{off} is the clamped inductive turn-off energy measured in accordance with JEDEC standard JESD24-1.

Microsemi reserves the right to change, without notice, the specifications and information contained herein.

Typical Performance Curves

APT35GA90B_S

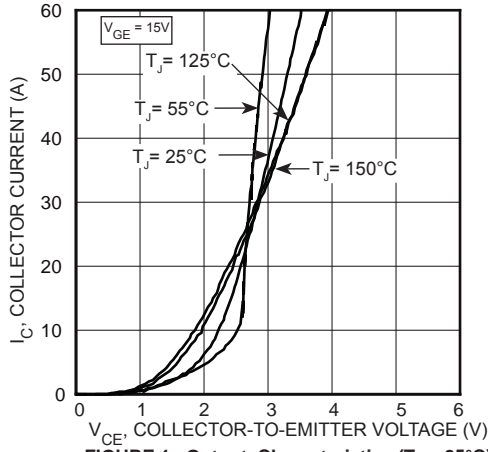

FIGURE 1, Output Characteristics ($T_J = 25^\circ\text{C}$)

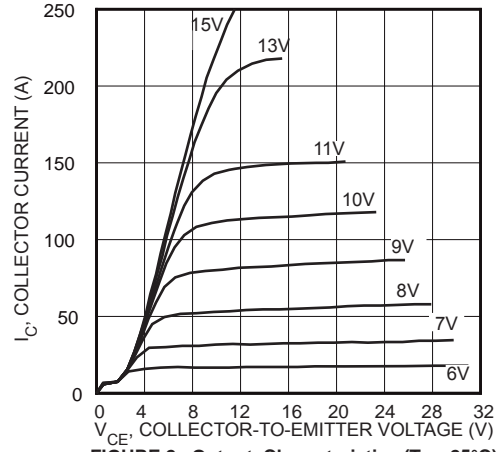

FIGURE 2, Output Characteristics ($T_J = 25^\circ\text{C}$)

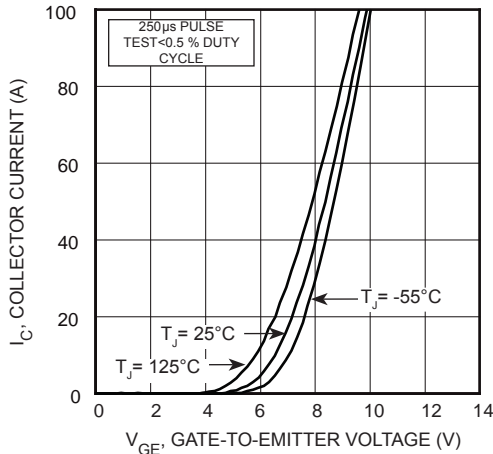

FIGURE 3, Transfer Characteristics

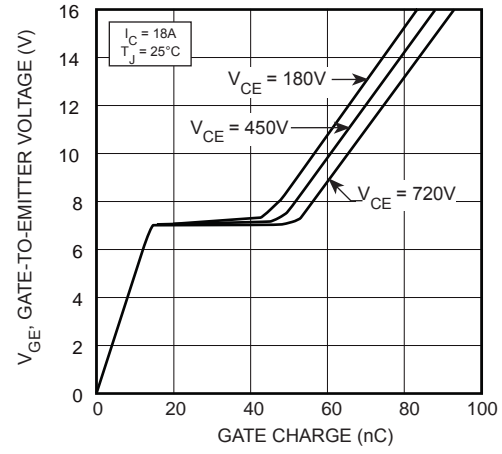

FIGURE 4, Gate charge

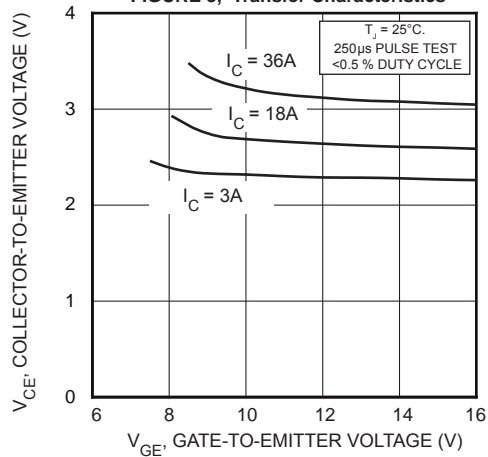

FIGURE 5, On State Voltage vs Gate-to-Emitter Voltage

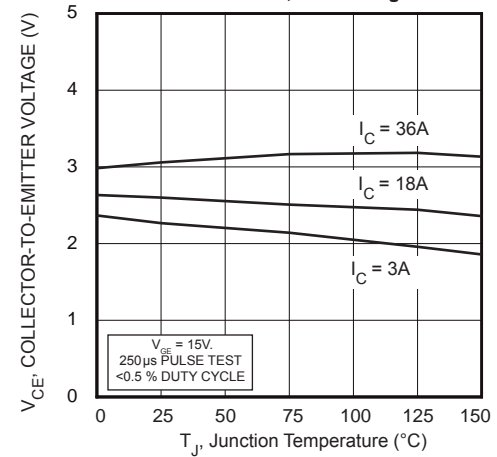

FIGURE 6, On State Voltage vs Junction Temperature

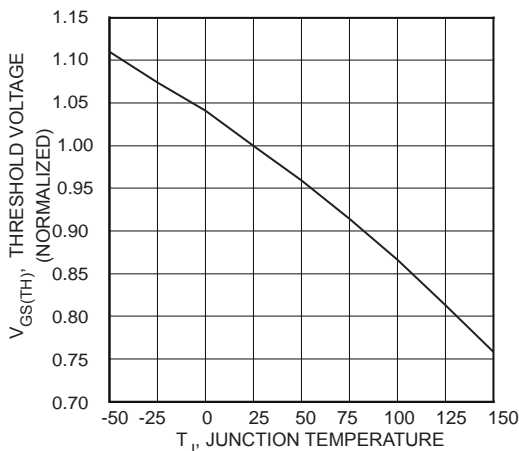

FIGURE 7, Threshold Voltage vs Junction Temperature

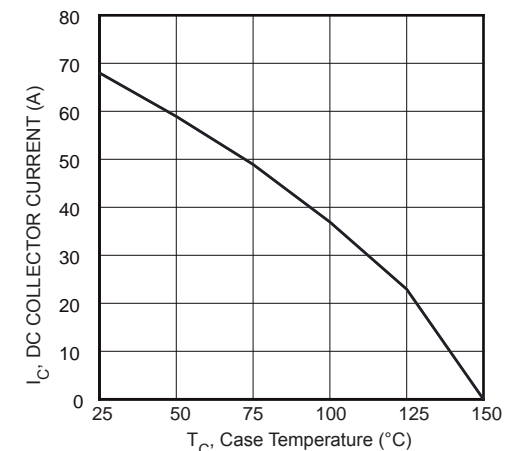

FIGURE 8, DC Collector Current vs Case Temperature

Typical Performance Curves

APT35GA90B_S

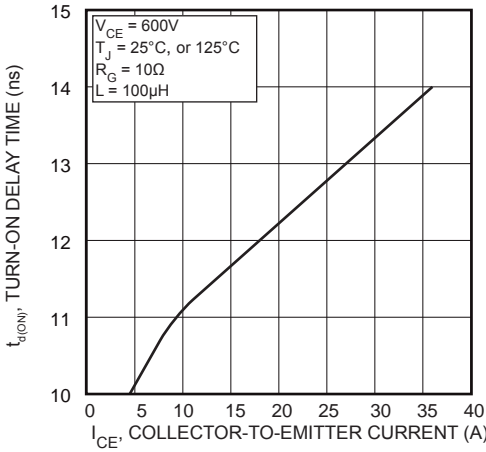

FIGURE 9, Turn-On Delay Time vs Collector Current

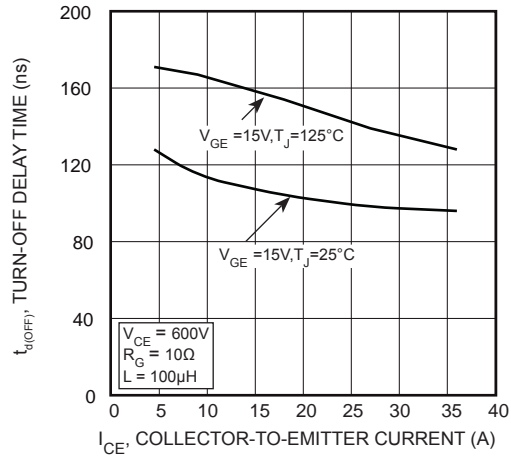

FIGURE 10, Turn-Off Delay Time vs Collector Current

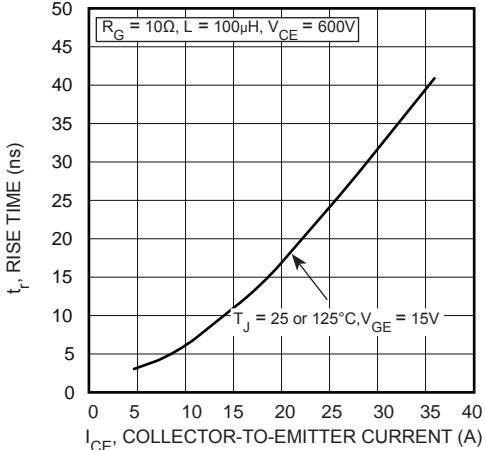

FIGURE 11, Current Rise Time vs Collector Current

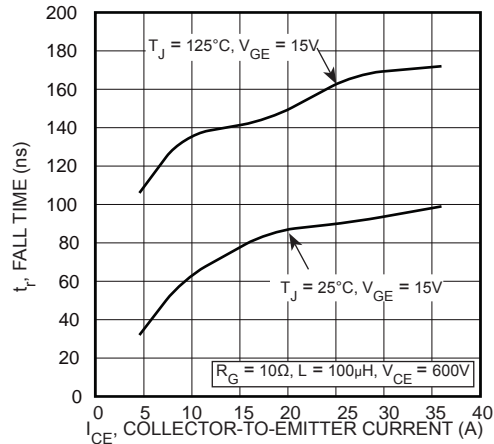

FIGURE 12, Current Fall Time vs Collector Current

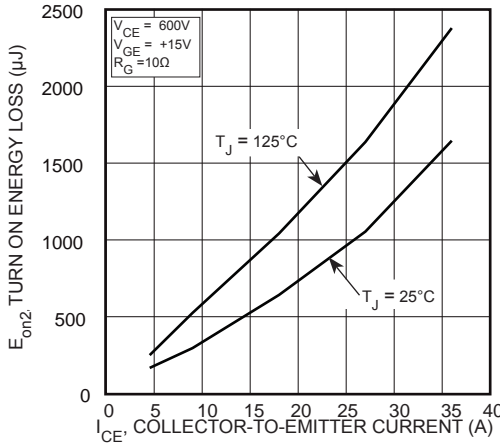

FIGURE 13, Turn-On Energy Loss vs Collector Current

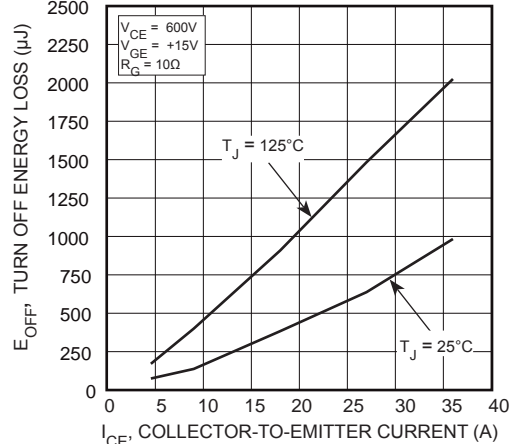

FIGURE 14, Turn-Off Energy Loss vs Collector Current

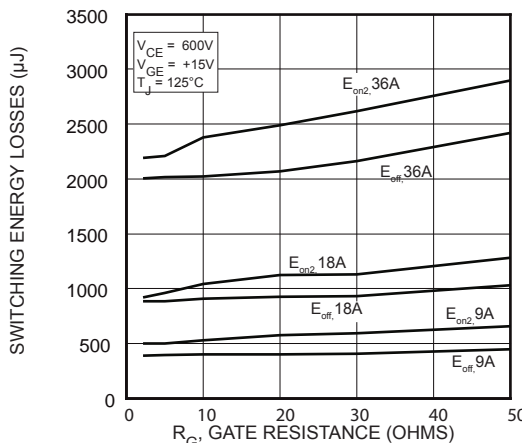

FIGURE 15, Switching Energy Losses vs Gate Resistance

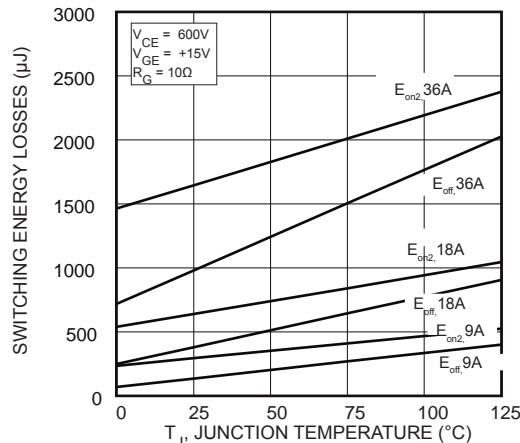

FIGURE 16, Switching Energy Losses vs Junction Temperature

Typical Performance Curves

APT35GA90B_S

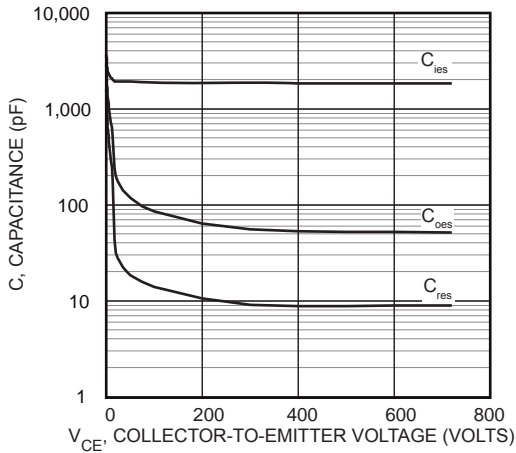

FIGURE 17, Capacitance vs Collector-To-Emitter Voltage

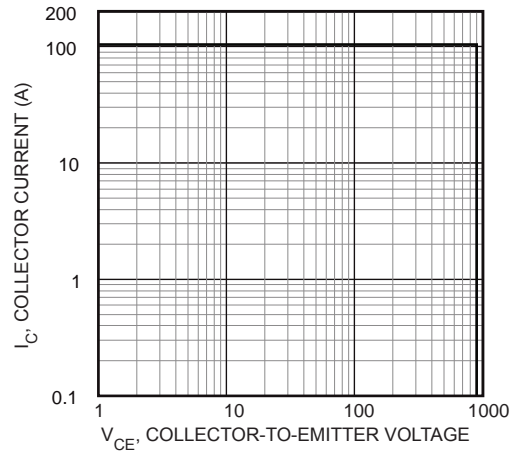

FIGURE 18, Minimum Switching Safe Operating Area

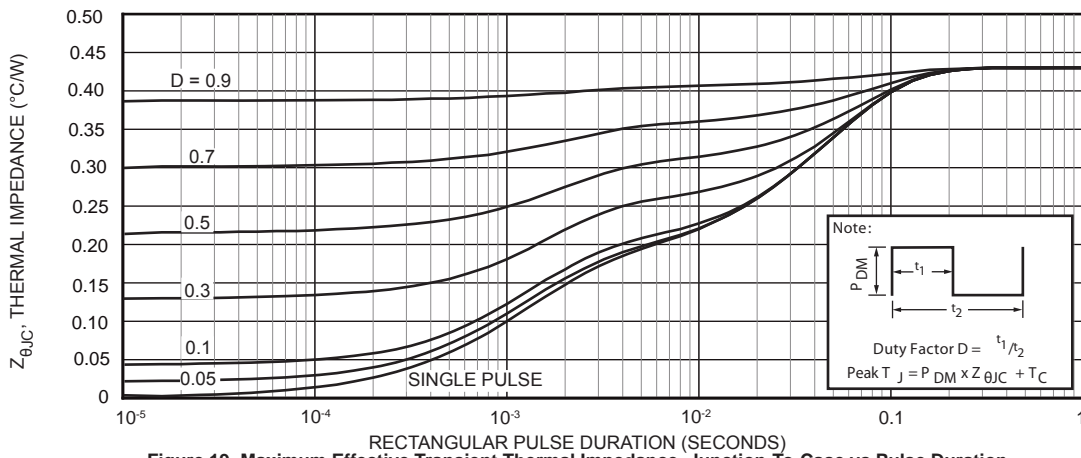

Figure 19, Maximum Effective Transient Thermal Impedance, Junction-To-Case vs Pulse Duration

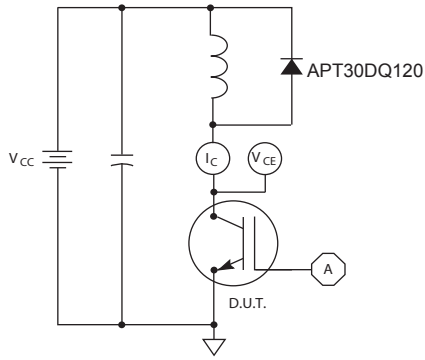

Figure 20, Inductive Switching Test Circuit

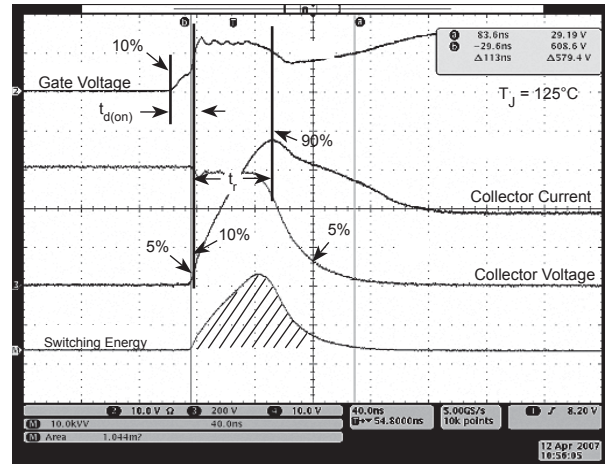

Figure 21, Turn-on Switching Waveforms and Definitions

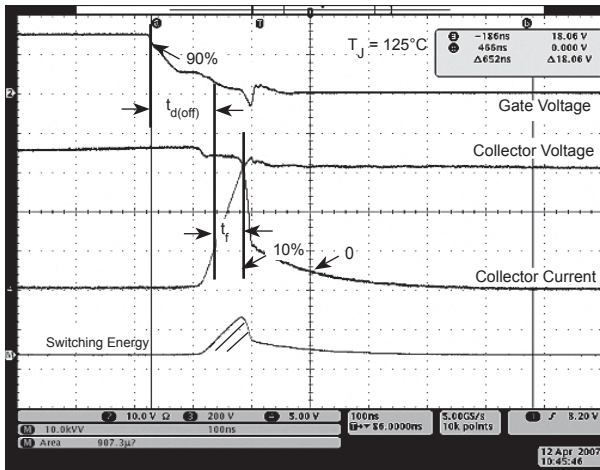
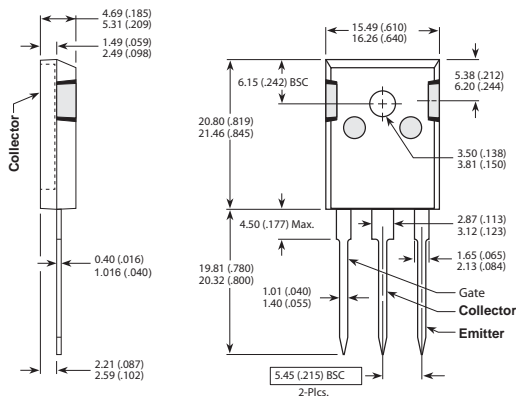

Figure 22, Turn-off Switching Waveforms and Definitions

TO-247 Package Outline

Ⓔ1 SAC: Tin, Silver, Copper



Dimensions in Millimeters (Inches)

D³PAK Package Outline

Ⓔ3 100% Sn Plated

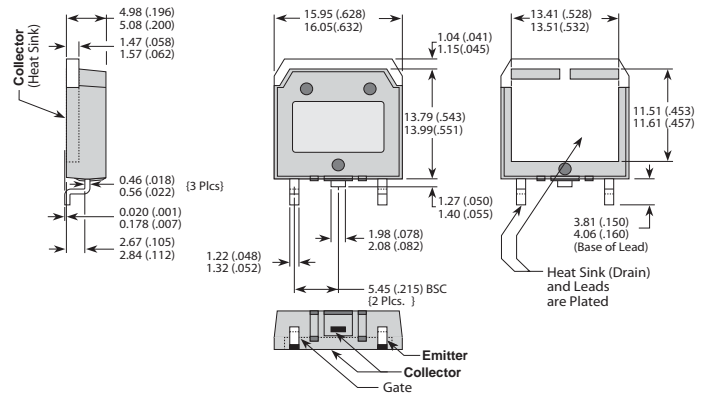

Dimensions in Millimeters (Inches)

Mouser Electronics

Authorized Distributor

Click to View Pricing, Inventory, Delivery & Lifecycle Information:

[Microchip:](#)

[APT35GA90B](#)