



Highbright 0603 ChipLED



DESCRIPTION

The new ChipLED series have been designed in the smallest SMD package. This innovative ChipLED technology opens the way to

- smaller products of higher performance
- more design in flexibility
- enhanced applications

The 0603 LED is an obvious solution for small-scale, high brightness products that are expected to work reliably in an arduous environment.

PRODUCT GROUP AND PACKAGE DATA

- Product group: LED
- Package: SMD 0603 ChipLED
- Product series: standard
- Angle of half intensity: $\pm 65^\circ$

FEATURE

- Super thin ChipLED with exceptional brightness 1.6 mm x 0.8 mm x 0.8 mm (L x W x H)
- High reliability PCB based
- Wavelength (465 to 475) nm (blue), typ. 525 nm (true green), typ. 571 nm (yellow green), (584.5 to 597) nm (yellow), typ. 605 nm (soft orange), typ. 631 nm (super red)
- InGaN blue available with protection diode, device type VLMB1310 with HBM 8000 V
- AllInGaP and InGaN technology
- Viewing angle: Extremely wide 130°
- Grouping parameter: Luminous intensity, wavelength, V_f
- Available in 8 mm tape on 7" diameter reel
- Compatible to IR reflow soldering
- Preconditioning according to JEDEC® level 3
- Material categorization: for definitions of compliance please see www.vishay.com/doc?99912



APPLICATIONS

- Backlight keypads
- Navigation systems
- Cellular phone displays
- Displays for industrial control systems
- Miniaturized color effects
- Traffic displays

| PARTS TABLE | | | | | | | | | | | | | | |
|----------------|--------------|--------------------------|------|------|---------------|-----------------|------|------|---------------|---------------------|------|------|---------------|------------|
| PART | COLOR | LUMINOUS INTENSITY (mcd) | | | at I_f (mA) | WAVELENGTH (nm) | | | at I_f (mA) | FORWARD VOLTAGE (V) | | | at I_f (mA) | TECHNOLOGY |
| | | MIN. | TYP. | MAX. | | MIN. | TYP. | MAX. | | MIN. | TYP. | MAX. | | |
| VLMS1300-GS08 | Super red | 18 | 54 | - | 20 | - | 631 | - | 20 | - | 2.0 | 2.4 | 20 | AllInGaP |
| VLMO1300-GS08 | Soft orange | 45 | 90 | - | 20 | - | 605 | - | 20 | - | 2.0 | 2.4 | 20 | AllInGaP |
| VLMY1300-GS08 | Yellow | 28 | - | 180 | 20 | 584.5 | - | 597 | 20 | 1.8 | - | 2.4 | 20 | AllInGaP |
| VLMY1301-GS08 | Yellow | 71 | - | 180 | 20 | 584.5 | - | 597 | 20 | 1.8 | - | 2.4 | 20 | AllInGaP |
| VLMG1300-GS08 | Yellow green | 18 | 35 | - | 20 | - | 571 | - | 20 | - | 2.0 | 2.4 | 20 | AllInGaP |
| VLMTG1300-GS08 | True green | 71 | - | 450 | 20 | - | 525 | - | 20 | 2.8 | 3.2 | 3.6 | 20 | InGaN |
| VLMB1300-GS08 | Blue | 28 | - | 180 | 20 | 465 | - | 475 | 20 | 2.8 | - | 3.8 | 20 | InGaN |
| VLMB1302-GS08 | Blue | 45 | - | 112 | 20 | 465 | - | 475 | 20 | 2.8 | - | 3.8 | 20 | InGaN |
| VLMB1310-GS08 | Blue | 28 | - | 180 | 20 | 465 | - | 475 | 20 | 2.8 | - | 3.8 | 20 | InGaN |



| ABSOLUTE MAXIMUM RATINGS ($T_{amb} = 25\text{ }^{\circ}\text{C}$, unless otherwise specified) VLMS1300, VLMO1300, VLMY1300, VLMY1301, VLMG1300 (AlInGaP technology) | | | | |
|--|---|-----------|------------|--------------------|
| PARAMETER | TEST CONDITION | SYMBOL | VALUE | UNIT |
| Reverse voltage ⁽¹⁾ | | V_R | 5 | V |
| DC forward current | | I_F | 30 | mA |
| Surge forward current | 1/10 duty cycle, 0.1 ms pulse width | I_{FSM} | 80 | mA |
| Power dissipation | $T_{amb} \leq 25\text{ }^{\circ}\text{C}$ | P_V | 75 | mW |
| Operating temperature range | | T_{amb} | -35 to +85 | $^{\circ}\text{C}$ |
| Storage temperature range | | T_{stg} | -45 to +85 | $^{\circ}\text{C}$ |
| IRED solder conditions | According Vishay specifications | T_{st} | 260 | $^{\circ}\text{C}$ |

Note

⁽¹⁾ Driving the LED in reverse direction is suitable for short term application

| ABSOLUTE MAXIMUM RATINGS ($T_{amb} = 25\text{ }^{\circ}\text{C}$, unless otherwise specified) VLMTG1300, VLMB1300, VLMB1302, VLMB1310 (InGaN technology) | | | | |
|---|---|-----------------|-------------|--------------------|
| PARAMETER | TEST CONDITION | SYMBOL | VALUE | UNIT |
| DC forward current | | I_F | 20 | mA |
| Surge forward current | 1/10 duty cycle, 0.1 ms pulse width | I_{FSM} | 100 | mA |
| Power dissipation | $T_{amb} \leq 25\text{ }^{\circ}\text{C}$ | P_V | 76 | mW |
| ESD threshold, for VLMB1310 with protection only | HBM | $th_{ESD\ HBM}$ | 8000 | V |
| Operating temperature range | | T_{amb} | -20 to +80 | $^{\circ}\text{C}$ |
| Storage temperature range | | T_{stg} | -30 to +100 | $^{\circ}\text{C}$ |
| IRED solder conditions | According Vishay specifications | T_{st} | 260 | $^{\circ}\text{C}$ |

| OPTICAL AND ELECTRICAL CHARACTERISTICS ($T_{amb} = 25\text{ }^{\circ}\text{C}$, unless otherwise specified) VLMS1300, SUPER RED | | | | | | |
|--|--------------------------------------|-----------------|------|----------|------|---------------|
| PARAMETER | TEST CONDITION | SYMBOL | MIN. | TYP. | MAX. | UNIT |
| Luminous intensity | $I_F = 20\text{ mA}$ | I_V | 18 | 54 | - | mcd |
| Dominant wavelength | $I_F = 20\text{ mA}$ | λ_d | - | 631 | - | nm |
| Peak wavelength | $I_F = 20\text{ mA}$ | λ_p | - | 639 | - | nm |
| Angle of half intensity | $I_F = 20\text{ mA}$ | φ | - | ± 65 | - | $^{\circ}$ |
| Spectral line half width | $I_F = 20\text{ mA}$ | $\Delta\lambda$ | - | 20 | - | nm |
| Forward voltage | $I_F = 20\text{ mA}$ | V_F | - | 2.0 | 2.4 | V |
| Junction capacitance | $V_R = 0\text{ V}, f = 1\text{ MHz}$ | C_j | - | 40 | - | pF |
| Reverse current | $V_R = 5\text{ V}$ | I_R | - | - | 10 | μA |

| OPTICAL AND ELECTRICAL CHARACTERISTICS ($T_{amb} = 25\text{ }^{\circ}\text{C}$, unless otherwise specified) VLMO1300, SOFT ORANGE | | | | | | |
|--|--------------------------------------|-----------------|------|----------|------|---------------|
| PARAMETER | TEST CONDITION | SYMBOL | MIN. | TYP. | MAX. | UNIT |
| Luminous intensity | $I_F = 20\text{ mA}$ | I_V | 45 | 90 | - | mcd |
| Dominant wavelength | $I_F = 20\text{ mA}$ | λ_d | - | 605 | - | nm |
| Peak wavelength | $I_F = 20\text{ mA}$ | λ_p | - | 611 | - | nm |
| Angle of half intensity | $I_F = 20\text{ mA}$ | φ | - | ± 65 | - | $^{\circ}$ |
| Spectral line half width | $I_F = 20\text{ mA}$ | $\Delta\lambda$ | - | 17 | - | nm |
| Forward voltage | $I_F = 20\text{ mA}$ | V_F | - | 2.0 | 2.4 | V |
| Junction capacitance | $V_R = 0\text{ V}, f = 1\text{ MHz}$ | C_j | - | 40 | - | pF |
| Reverse current | $V_R = 5\text{ V}$ | I_R | - | - | 10 | μA |



| OPTICAL AND ELECTRICAL CHARACTERISTICS ($T_{amb} = 25\text{ }^{\circ}\text{C}$, unless otherwise specified) VLMY1300, VLMY1301, YELLOW | | | | | | | |
|---|--------------------------------------|-------------|-----------------|-------|----------|------|---------------|
| PARAMETER | TEST CONDITION | PART NUMBER | SYMBOL | MIN. | TYP. | MAX. | UNIT |
| Luminous intensity | $I_F = 20\text{ mA}$ | VLMY1300 | I_V | 28 | - | 180 | mcd |
| | | VLMY1301 | I_V | 71 | - | 180 | mcd |
| Dominant wavelength | $I_F = 20\text{ mA}$ | | λ_d | 584.5 | - | 597 | nm |
| Peak wavelength | $I_F = 20\text{ mA}$ | | λ_p | - | 588 | - | nm |
| Angle of half intensity | $I_F = 20\text{ mA}$ | | ϕ | - | ± 65 | - | $^{\circ}$ |
| Spectral line half width | $I_F = 20\text{ mA}$ | | $\Delta\lambda$ | - | 15 | - | nm |
| Forward voltage | $I_F = 20\text{ mA}$ | | V_F | 1.8 | - | 2.4 | V |
| Junction capacitance | $V_R = 0\text{ V}, f = 1\text{ MHz}$ | | C_j | - | 40 | - | pF |
| Reverse current | $V_R = 5\text{ V}$ | | I_R | - | - | 10 | μA |

| OPTICAL AND ELECTRICAL CHARACTERISTICS ($T_{amb} = 25\text{ }^{\circ}\text{C}$, unless otherwise specified) VLMG1300, YELLOW GREEN | | | | | | | |
|---|--------------------------------------|-----------------|------|----------|------|---------------|--|
| PARAMETER | TEST CONDITION | SYMBOL | MIN. | TYP. | MAX. | UNIT | |
| Luminous intensity | $I_F = 20\text{ mA}$ | I_V | 18 | 35 | - | mcd | |
| Dominant wavelength | $I_F = 20\text{ mA}$ | λ_d | - | 571 | - | nm | |
| Peak wavelength | $I_F = 20\text{ mA}$ | λ_p | - | 574 | - | nm | |
| Angle of half intensity | $I_F = 20\text{ mA}$ | ϕ | - | ± 65 | - | $^{\circ}$ | |
| Spectral line half width | $I_F = 20\text{ mA}$ | $\Delta\lambda$ | - | 15 | - | nm | |
| Forward voltage | $I_F = 20\text{ mA}$ | V_F | - | 2.0 | 2.4 | V | |
| Junction capacitance | $V_R = 0\text{ V}, f = 1\text{ MHz}$ | C_j | - | 40 | - | pF | |
| Reverse current | $V_R = 5\text{ V}$ | I_R | - | - | 10 | μA | |

| OPTICAL AND ELECTRICAL CHARACTERISTICS ($T_{amb} = 25\text{ }^{\circ}\text{C}$, unless otherwise specified) VLMTG1300, TRUE GREEN | | | | | | | |
|--|----------------------|-----------------|------|----------|------|---------------|--|
| PARAMETER | TEST CONDITION | SYMBOL | MIN. | TYP. | MAX. | UNIT | |
| Luminous intensity | $I_F = 20\text{ mA}$ | I_V | 71 | - | 450 | mcd | |
| Dominant wavelength | $I_F = 20\text{ mA}$ | λ_d | - | 525 | - | nm | |
| Peak wavelength | $I_F = 20\text{ mA}$ | λ_p | - | 530 | - | nm | |
| Angle of half intensity | $I_F = 20\text{ mA}$ | ϕ | - | ± 65 | - | $^{\circ}$ | |
| Spectral line half width | $I_F = 20\text{ mA}$ | $\Delta\lambda$ | - | 35 | - | nm | |
| Forward voltage | $I_F = 20\text{ mA}$ | V_F | 2.8 | 3.2 | 3.6 | V | |
| Reverse current | $V_R = 5\text{ V}$ | I_R | - | - | 10 | μA | |

| OPTICAL AND ELECTRICAL CHARACTERISTICS ($T_{amb} = 25\text{ }^{\circ}\text{C}$, unless otherwise specified) VLMB1300, VLMB1302, VLMB1310, BLUE | | | | | | | |
|---|----------------------|-------------|-----------------|------|----------|------|---------------|
| PARAMETER | TEST CONDITION | PART NUMBER | SYMBOL | MIN. | TYP. | MAX. | UNIT |
| Luminous intensity | $I_F = 20\text{ mA}$ | VLMB1300 | I_V | 28 | - | 180 | mcd |
| | | VLMB1302 | I_V | 45 | - | 112 | mcd |
| | | VLMB1310 | I_V | 28 | - | 180 | mcd |
| Dominant wavelength | $I_F = 20\text{ mA}$ | | λ_d | 465 | - | 475 | nm |
| Peak wavelength | $I_F = 20\text{ mA}$ | | λ_p | - | 468 | - | nm |
| Angle of half intensity | $I_F = 20\text{ mA}$ | | ϕ | - | ± 65 | - | $^{\circ}$ |
| Spectral line half width | $I_F = 20\text{ mA}$ | | $\Delta\lambda$ | - | 25 | - | nm |
| Forward voltage | $I_F = 20\text{ mA}$ | | V_F | 2.8 | - | 3.8 | V |
| Reverse current (except VLMB1310) | $V_R = 5\text{ V}$ | | I_R | - | - | 10 | μA |
| Reverse voltage (VLMB1310 only) | $I_R = 10\text{ mA}$ | | V_R | 0.6 | - | 1.2 | V |



| LUMINOUS INTENSITY CLASSIFICATION | | |
|-----------------------------------|--------------------------|------|
| GROUP | LUMINOUS INTENSITY (mcd) | |
| | MIN. | MAX. |
| M | 18 | 28 |
| N | 28 | 45 |
| P | 45 | 71 |
| Q | 71 | 112 |
| R | 112 | 180 |
| S | 180 | 280 |
| T | 280 | 450 |

Note

- Luminous intensity is tested at a current pulse duration of 25 ms and an accuracy of $\pm 15\%$.
The above type numbers represent the order groups which include only a few brightness groups. Only one group will be shipped on each reel (there will be no mixing of two groups on each reel). In order to ensure availability, single brightness groups will not be orderable.
In a similar manner for colors where wavelength groups are measured and binned, single wavelength groups will be shipped in any one reel.
In order to ensure availability, single wavelength groups will not be orderable

| COLOR CLASSIFICATION | | | |
|----------------------|-------|--------------------------|-------|
| COLOR | GROUP | DOMINANT WAVELENGTH (nm) | |
| | | MIN. | MAX. |
| Yellow | H | 584.5 | 587.5 |
| | J | 587.5 | 589.5 |
| | K | 589.5 | 592 |
| | L | 592 | 594.5 |
| | M | 594.5 | 597 |
| Yellow green | C | 567.5 | 570.5 |
| | D | 570.5 | 573.5 |
| | E | 573.5 | 576.5 |
| True green | AP | 520 | 525 |
| | AQ | 525 | 530 |
| | AR | 530 | 535 |
| Blue | AC | 465 | 470 |
| | AD | 470 | 475 |

Note

- Wavelengths are tested at a current pulse duration of 25 ms and an accuracy of $\pm 1\text{ nm}$

| FORWARD VOLTAGE CLASSIFICATION | | | |
|--------------------------------|-------|---------------------|------|
| COLOR | GROUP | FORWARD VOLTAGE (V) | |
| | | MIN. | MAX. |
| Yellow | F2 | 1.8 | 2.1 |
| | F3 | 2.1 | 2.4 |
| Yellow green | 4 | 1.9 | 2 |
| | 5 | 2 | 2.1 |
| | 6 | 2.1 | 2.2 |
| | 7 | 2.2 | 2.3 |
| | 8 | 2.3 | 2.4 |
| True green | D7 | 2.8 | 3 |
| | D8 | 3 | 3.2 |
| | D9 | 3.2 | 3.4 |
| | D10 | 3.4 | 3.6 |
| Blue | D7 | 2.8 | 3 |
| | D8 | 3 | 3.2 |
| | D9 | 3.2 | 3.4 |
| | D10 | 3.4 | 3.6 |
| | D11 | 3.6 | 3.8 |

Note

- Forward voltage is measured with a tolerance of $\pm 0.1\text{ V}$



TYPICAL CHARACTERISTICS ($T_{amb} = 25\text{ }^{\circ}\text{C}$, unless otherwise specified)

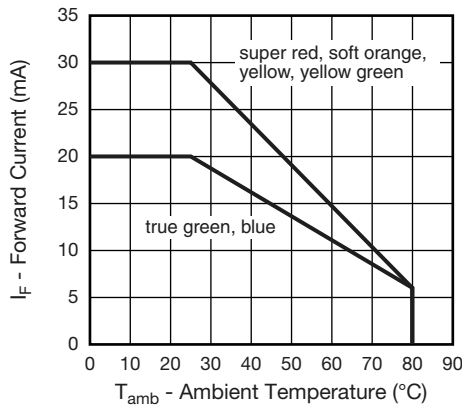

Fig. 1 - Forward Current vs. Ambient Temperature

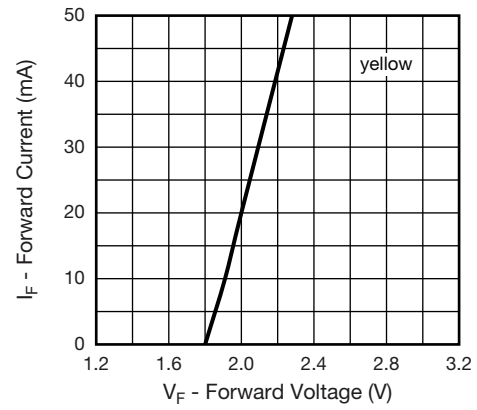

Fig. 4 - Forward Current vs. Forward Voltage (yellow)

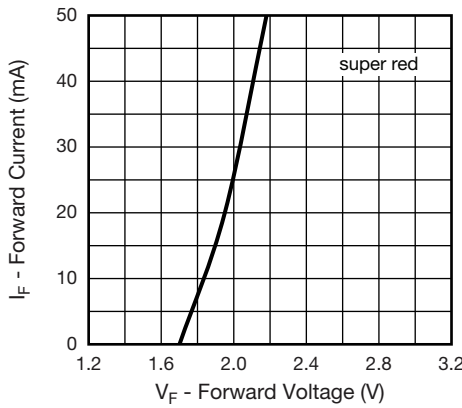

Fig. 2 - Forward Current vs. Forward Voltage (super red)

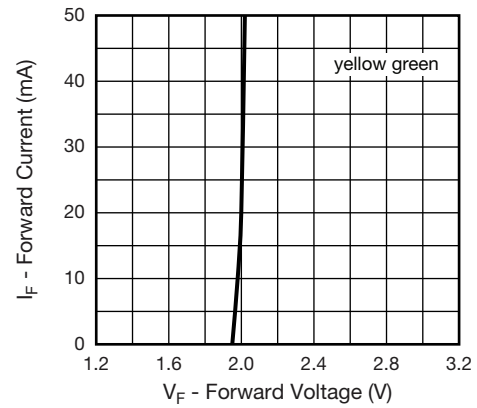

Fig. 5 - Forward Current vs. Forward Voltage (yellow green)

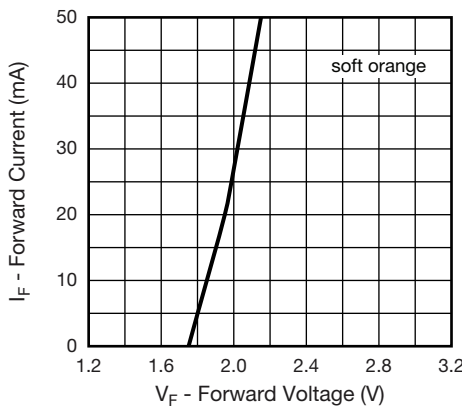

Fig. 3 - Forward Current vs. Forward Voltage (soft orange)

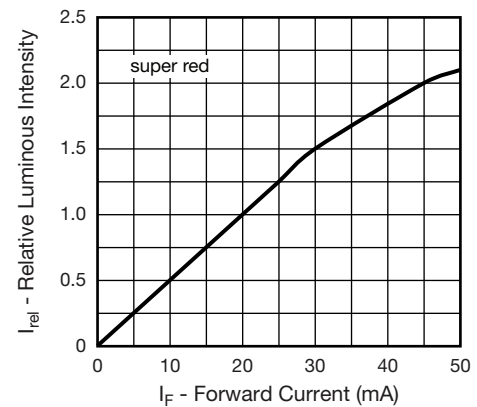

Fig. 6 - Relative Luminous Intensity vs. Forward Current (super red)

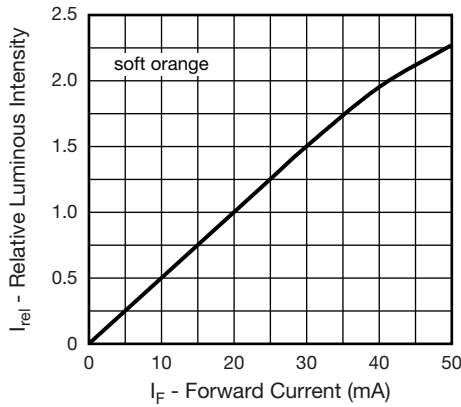

Fig. 7 - Relative Luminous Intensity vs. Forward Current (soft orange)

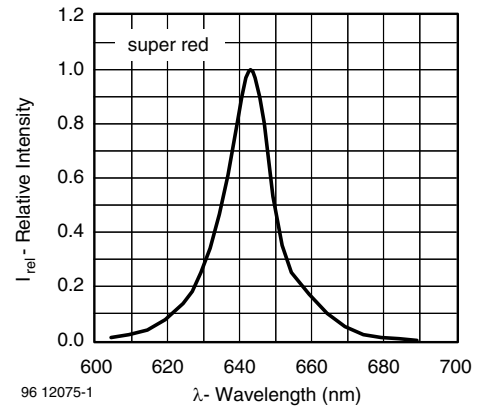

Fig. 10 - Relative Intensity vs. Wavelength (super red)

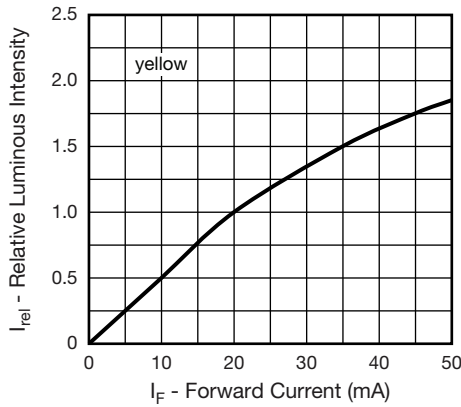

Fig. 8 - Relative Luminous Intensity vs. Forward Current (yellow)

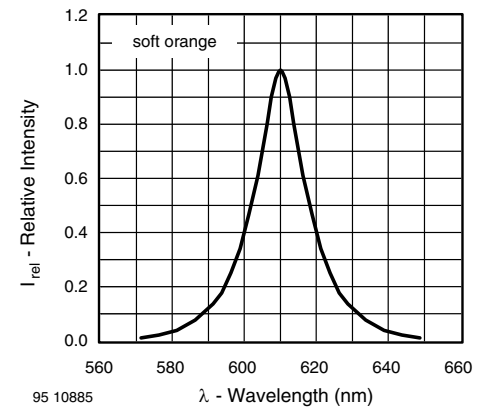

Fig. 11 - Relative Intensity vs. Wavelength (soft orange)

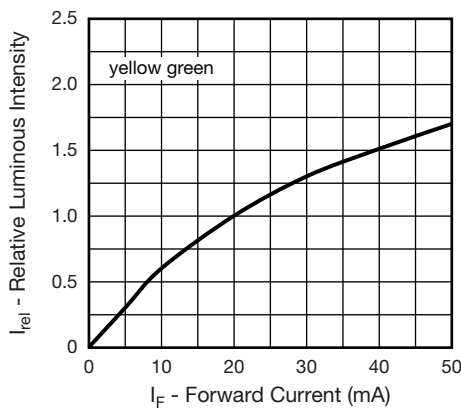

Fig. 9 - Relative Luminous Intensity vs. Forward Current (yellow green)

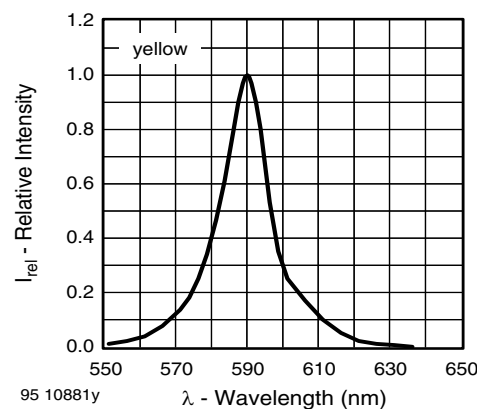

Fig. 12 - Relative Intensity vs. Wavelength (yellow)

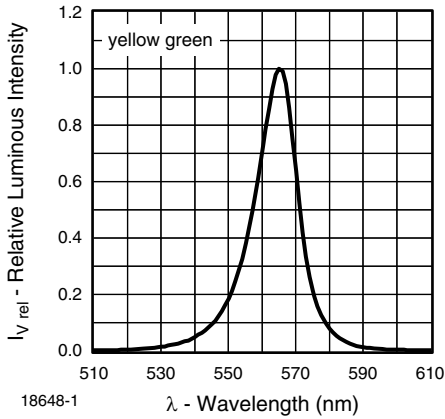

Fig. 13 - Relative Intensity vs. Wavelength (yellow green)

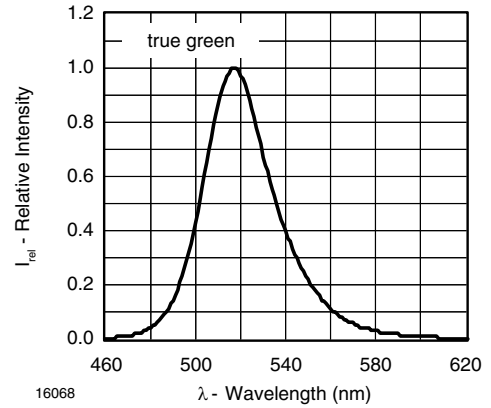

Fig. 16 - Relative Intensity vs. Wavelength (true green)

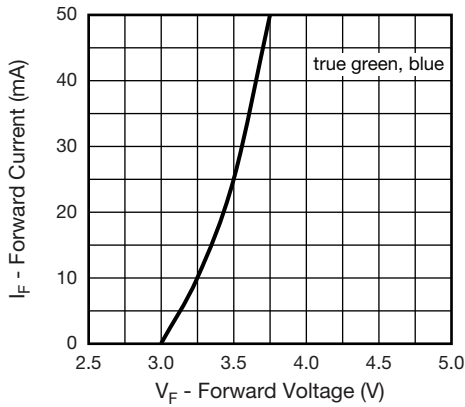

Fig. 14 - Forward Current vs. Forward Voltage (true green, blue)

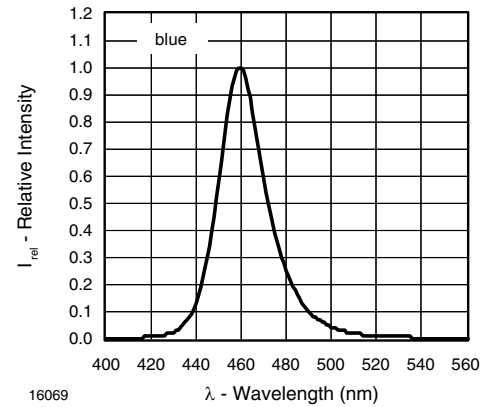

Fig. 17 - Relative Intensity vs. Wavelength (blue)

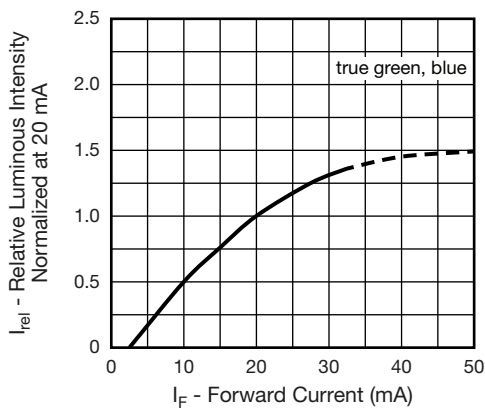

Fig. 15 - Relative Luminous Intensity vs. Forward Current (true green, blue)

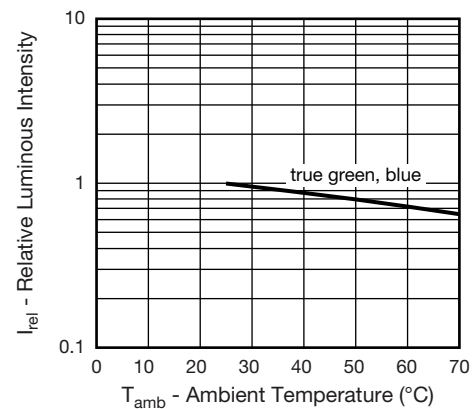

Fig. 18 - Relative Luminous Intensity vs. Ambient Temperature

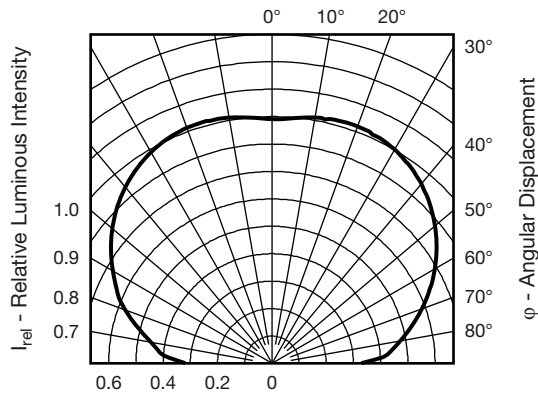
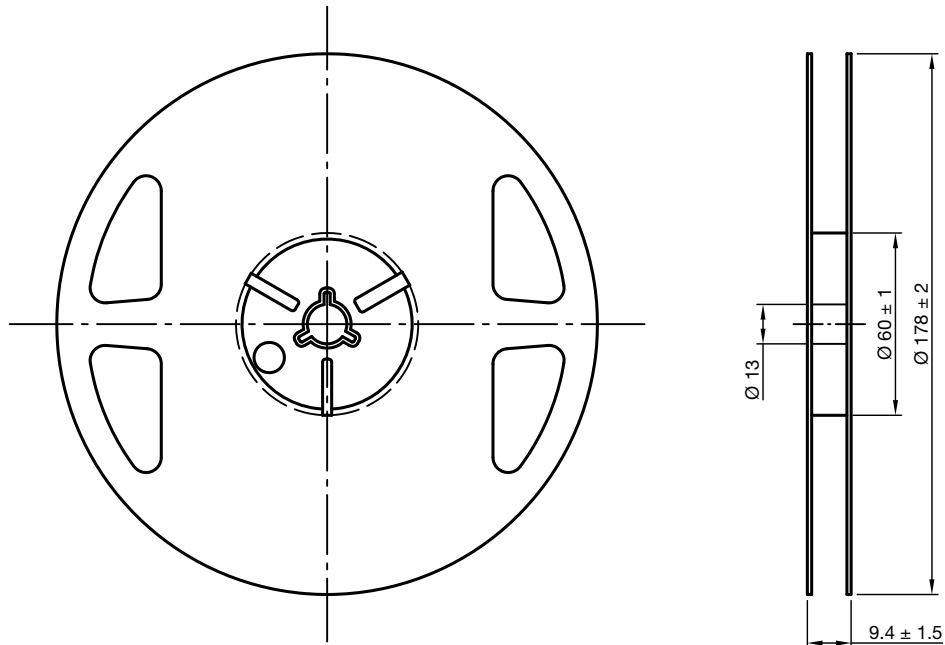
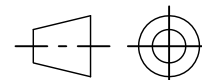

Fig. 19 - Relative Luminous Intensity vs. Angular Displacement

REEL DIMENSIONS in millimeters



Drawing-No.: 9.800-5122.01-4
Issue: 2; 03.11.11
22611



technical drawings
according to DIN
specifications



TAPE DIMENSIONS in millimeters

VLMB 13.., VLMY 13.., VLMO 13.., VLMS 13.., VLMB 13.., VLMB131..

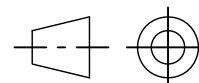
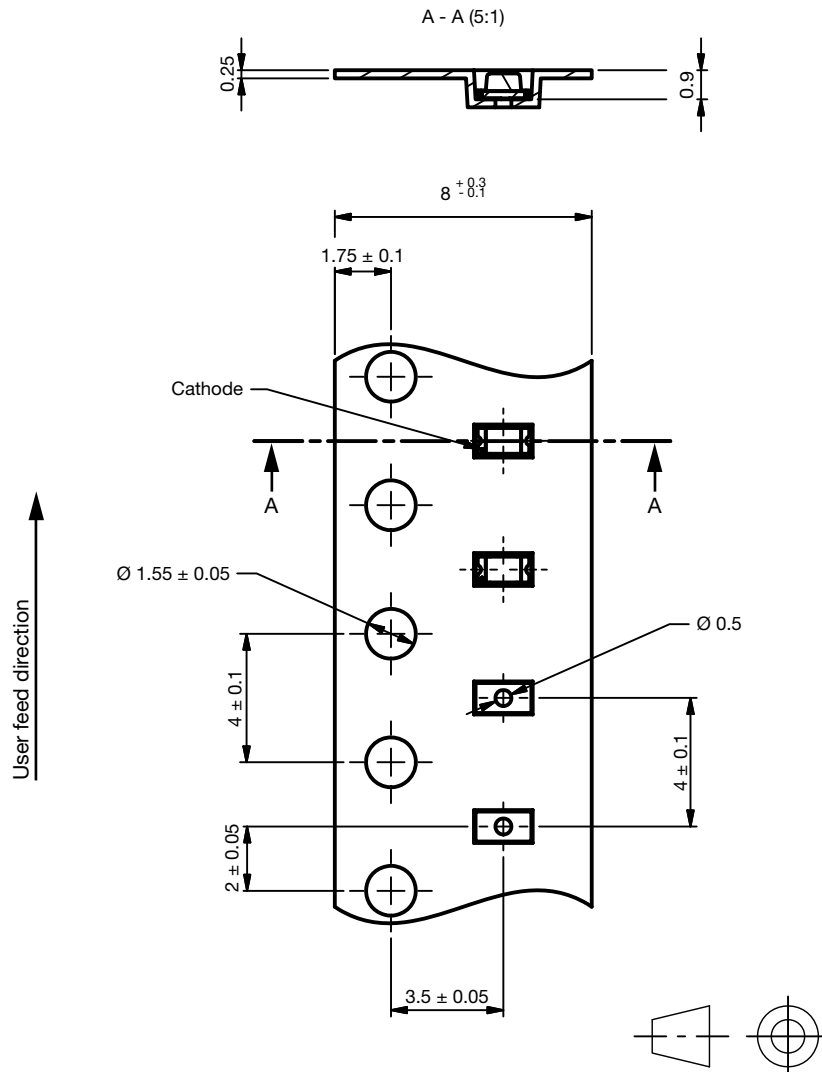

technical drawings according to DIN specifications

Drawing-No.: 9.700-5386.01-4
Issue: 1; 17.10.11
22614

Reels come in quantity of 3000 units
MOQ: 1 reel (3000 pcs)



PACKAGE DIMENSIONS in millimeters

VLMG 13.., VLMY 13.., VLMO 13.., VLMS 13..

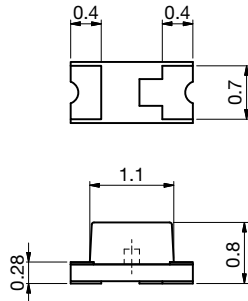

Recommended solder pad footprint

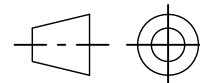
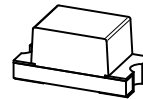
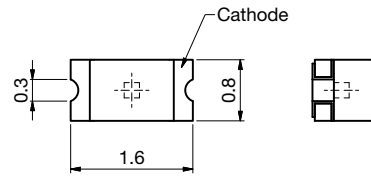
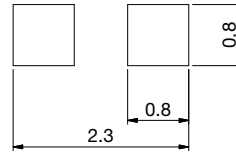

Not indicated tolerances ± 0.1

Drawing-No.: 6.541-5092.01-4
Issue: 2; 10.03.21

Technical drawings according to DIN specifications

VLMB 131..

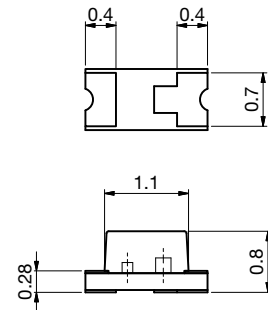

Recommended solder pad footprint

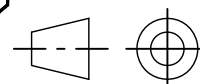
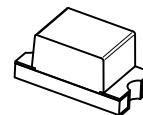
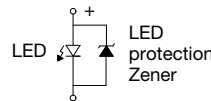
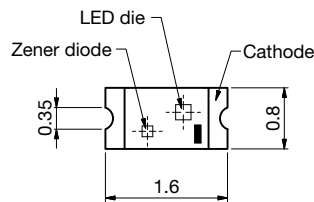
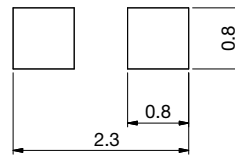

Not indicated tolerances ± 0.1

Drawing-No.: 6.541-5093.01-4
Issue: 2; 10.03.21

Technical drawings according to DIN specifications



VLMB 130., VLMTG 130.

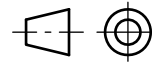
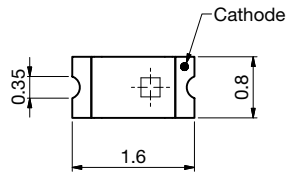
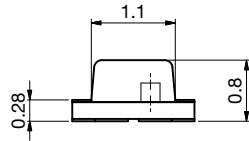
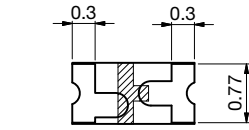

Technical drawings according to DIN specifications

Recommended solder pad footprint

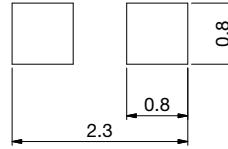

Not indicated tolerances ± 0.1

Drawing-No.: 6.541-5094.01-4
Issue: 2; 10.03.21

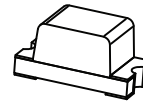

SOLDERING PROFILE

IR Reflow Soldering Profile for lead (Pb)-free Soldering
Preconditioning acc. to JEDEC Level 3

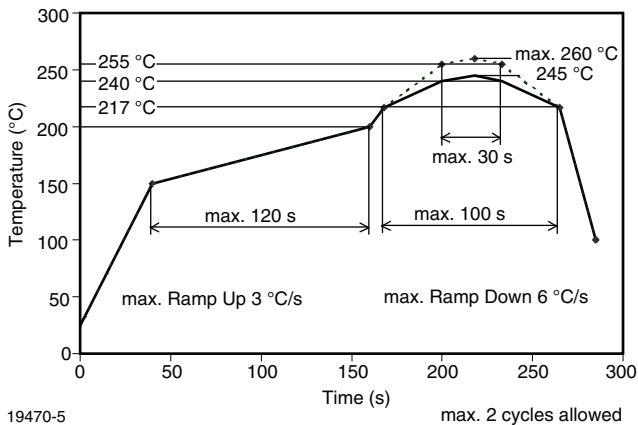
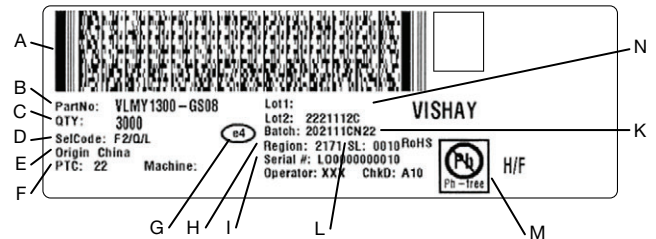

Fig. 20 - Vishay Lead (Pb)-free Reflow Soldering Profile (according to J-STD-020C)

BAR CODE PRODUCT LABEL (example only)



- A. 2D barcode
- B. Part No: Vishay part number
- C. QTY: quantity
- D. SelCode = selection bin code
- E. Country of origin
- F. PTC: production plant code
- G. Terminations finishing
- H. Region code
- I. Serial#: serial number
- K. Batch Number: year, week, country code, plant code
- L. SL: storage location
- M. Environmental Symbols: RoHS, lead (Pb)-free, halogen-free
- N. Lot numbers



DRY PACKING

The reel is packed in an anti-humidity bag to protect the devices from absorbing moisture during transportation and storage.

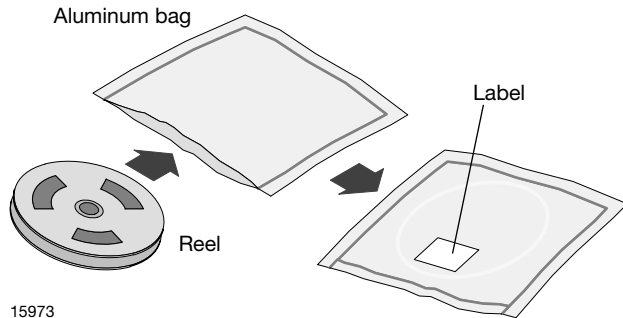

15973

FINAL PACKING

The sealed reel is packed into a cardboard box. A secondary cardboard box is used for shipping purposes.

RECOMMENDED METHOD OF STORAGE

Dry box storage is recommended as soon as the aluminum bag has been opened to prevent moisture absorption. The following conditions should be observed, if dry boxes are not available:

- Storage temperature 10 °C to 30 °C
- Storage humidity ≤ 60 % RH max.

After more than 168 h under these conditions moisture content will be too high for reflow soldering.

In case of moisture absorption, the devices will recover to the former condition by drying under the following condition:

192 h at 40 °C + 5 °C / - 0 °C and < 5 % RH (dry air / nitrogen) or

96 h at 60 °C + 5 °C and < 5 % RH for all device containers or

24 h at 100 °C + 5 °C not suitable for reel or tubes.

An EIA JEDEC standard JESD22-A112 level 3 label is included on all dry bags.

ESD PRECAUTION

Proper storage and handling procedures should be followed to prevent ESD damage to the devices especially when they are removed from the antistatic shielding bag. Electro-static sensitive devices warning labels are on the packaging.

VISHAY SEMICONDUCTORS STANDARD BAR CODE LABELS

The Vishay Semiconductors standard bar code labels are printed at final packing areas. The labels are on each packing unit and contain Vishay Semiconductors specific data.

| | | |
|---|---|-----------------------|
| | CAUTION This bag contains MOISTURE-SENSITIVE DEVICES | L E V E L 3 |
| 1. Shelf life in sealed bag 12 months at <40°C and <90% relative humidity (RH) | | |
| vapor-phase reflow, or equivalent processing (peak package body temp. 260°C) must be: | | |
| a) Mounted within 168 hours at factory condition of ≤ 30°C/60%RH or | | |
| b) Stored at ≤ 10% RH. | | |
| 3. Devices require baking before mounting if: | | |
| a) Humidity Indicator Card is >10% when read at 23°C ± 5°C or | | |
| b) 2a or 2b is not met. | | |
| 4. If baking is required, devices may be baked for: | | |
| 192 hours at 40°C + 5°C/40°C and <5%RH (dry air/nitrogen) or | | |
| 96 hours at 60±5°C and <5%RH For all device containers or | | |
| 24 hours at 100±5°C Not suitable for reels or tubes | | |
| Bag Seal Date: _____ (If blank, see bar code label) | | |
| Note: LEVEL defined by EIA JEDEC Standard JESD22-A112 | | |

20003

Example of JESD22-A112 Level 3 Label



Disclaimer

ALL PRODUCT, PRODUCT SPECIFICATIONS AND DATA ARE SUBJECT TO CHANGE WITHOUT NOTICE TO IMPROVE RELIABILITY, FUNCTION OR DESIGN OR OTHERWISE.

Vishay Intertechnology, Inc., its affiliates, agents, and employees, and all persons acting on its or their behalf (collectively, "Vishay"), disclaim any and all liability for any errors, inaccuracies or incompleteness contained in any datasheet or in any other disclosure relating to any product.

Vishay makes no warranty, representation or guarantee regarding the suitability of the products for any particular purpose or the continuing production of any product. To the maximum extent permitted by applicable law, Vishay disclaims (i) any and all liability arising out of the application or use of any product, (ii) any and all liability, including without limitation special, consequential or incidental damages, and (iii) any and all implied warranties, including warranties of fitness for particular purpose, non-infringement and merchantability.

Statements regarding the suitability of products for certain types of applications are based on Vishay's knowledge of typical requirements that are often placed on Vishay products in generic applications. Such statements are not binding statements about the suitability of products for a particular application. It is the customer's responsibility to validate that a particular product with the properties described in the product specification is suitable for use in a particular application. Parameters provided in datasheets and / or specifications may vary in different applications and performance may vary over time. All operating parameters, including typical parameters, must be validated for each customer application by the customer's technical experts. Product specifications do not expand or otherwise modify Vishay's terms and conditions of purchase, including but not limited to the warranty expressed therein.

Hyperlinks included in this datasheet may direct users to third-party websites. These links are provided as a convenience and for informational purposes only. Inclusion of these hyperlinks does not constitute an endorsement or an approval by Vishay of any of the products, services or opinions of the corporation, organization or individual associated with the third-party website. Vishay disclaims any and all liability and bears no responsibility for the accuracy, legality or content of the third-party website or for that of subsequent links.

Except as expressly indicated in writing, Vishay products are not designed for use in medical, life-saving, or life-sustaining applications or for any other application in which the failure of the Vishay product could result in personal injury or death. Customers using or selling Vishay products not expressly indicated for use in such applications do so at their own risk. Please contact authorized Vishay personnel to obtain written terms and conditions regarding products designed for such applications.

No license, express or implied, by estoppel or otherwise, to any intellectual property rights is granted by this document or by any conduct of Vishay. Product names and markings noted herein may be trademarks of their respective owners.