

Click [here](#) to ask about the production status of specific part numbers.

DG1206/DG1207

Low-Leakage, Single 16-Channel and Dual 8-Channel, Analog Multiplexer

General Description

The DG1206 and DG1207 are low-leakage, low-charge-injection single 16-channel or dual 8-channel multiplexing switch devices. The DG1206 uses four selection inputs A3, A2, A1, and A0 to determine the switching logic; the DG1207 uses three selection inputs A2, A1, and A0. On both devices, an enable (EN) input is used to enable or disable the device.

The ultra-low capacitance and low-charge injection of the DG1206/DG1207 make them ideal for automatic test equipment systems, data acquisition systems, and sample-and-hold systems where low glitch and fast settling time are required.

The DG1206/DG1207 are available in 5mm x 5mm 32-lead TQFN or 28-lead TSSOP packages. The devices are specified for operation over the -40°C to +85°C temperature range.

Applications

- Automatic Test Equipment Systems
- Data Acquisition Systems
- Sample-and-Hold Systems
- Communication Systems
- Audio and Video Routing

Benefits and Features

- Distortion-Free Measurement
 - 100Ω (typ) On Resistance
 - ≤ 2nA (max) On/Off-Leakage Current for DG1206
 - ≤ 1nA (max) On/Off-Leakage Current for DG1207
 - ≤ 0.5pC (typ) Charge Injection
- Wide Supply Range with Low Supply Current
 - 40μA (typ) Quiescent Current at Room Temperature
 - Fully Specified with ±15V Bipolar Supplies or +12V Single Supply
 - Rail-to-Rail Operation
- Flexible Design Option
 - GPIO-Compatible Control Inputs
 - EN Input to Enable/Disable Device
 - Available in both 32-TQFN and 28-TSSOP Packages
 - -40°C to +85°C Temperature Range

[Ordering Information](#) appears at end of data sheet.

Simplified Block Diagram

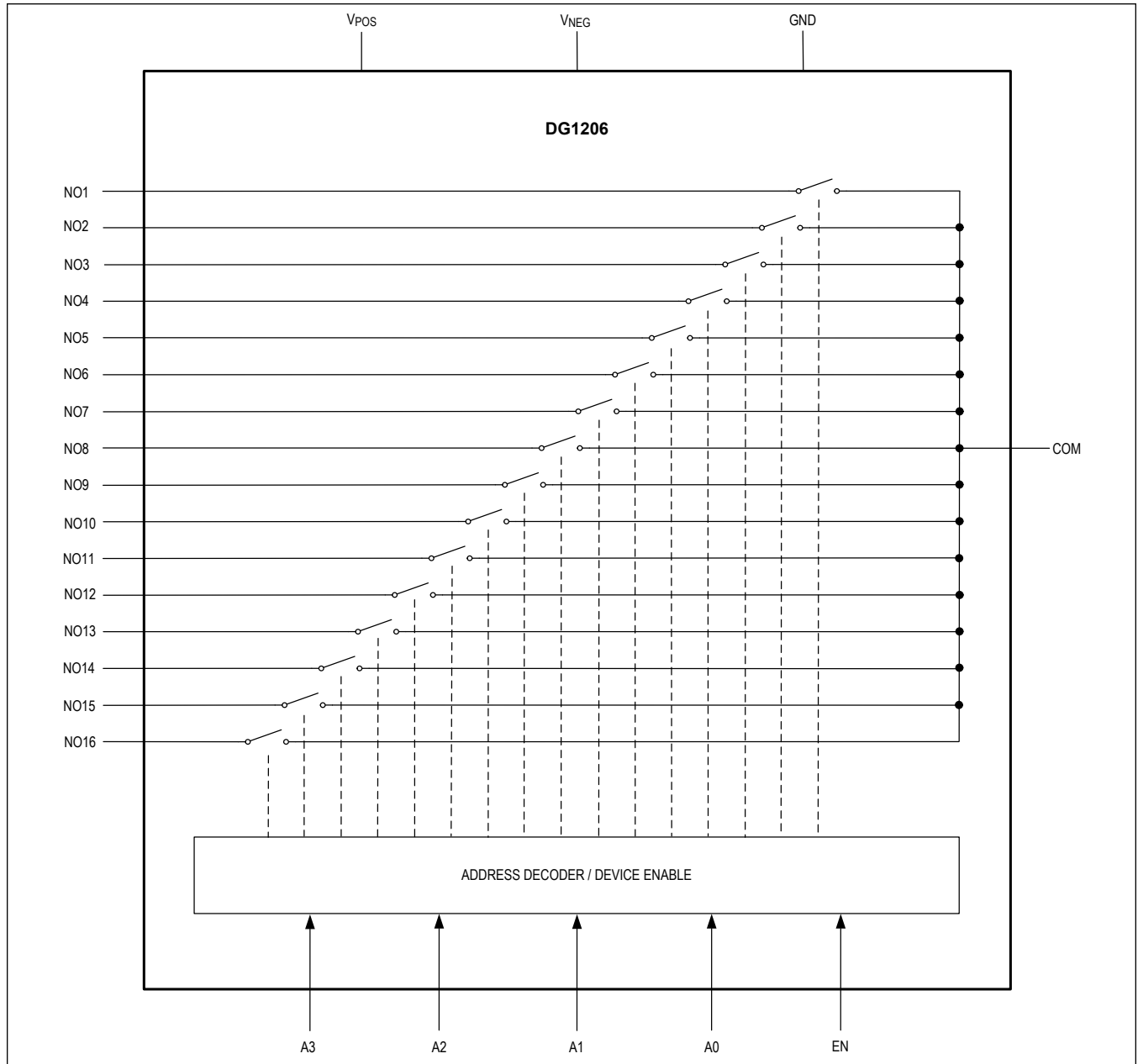

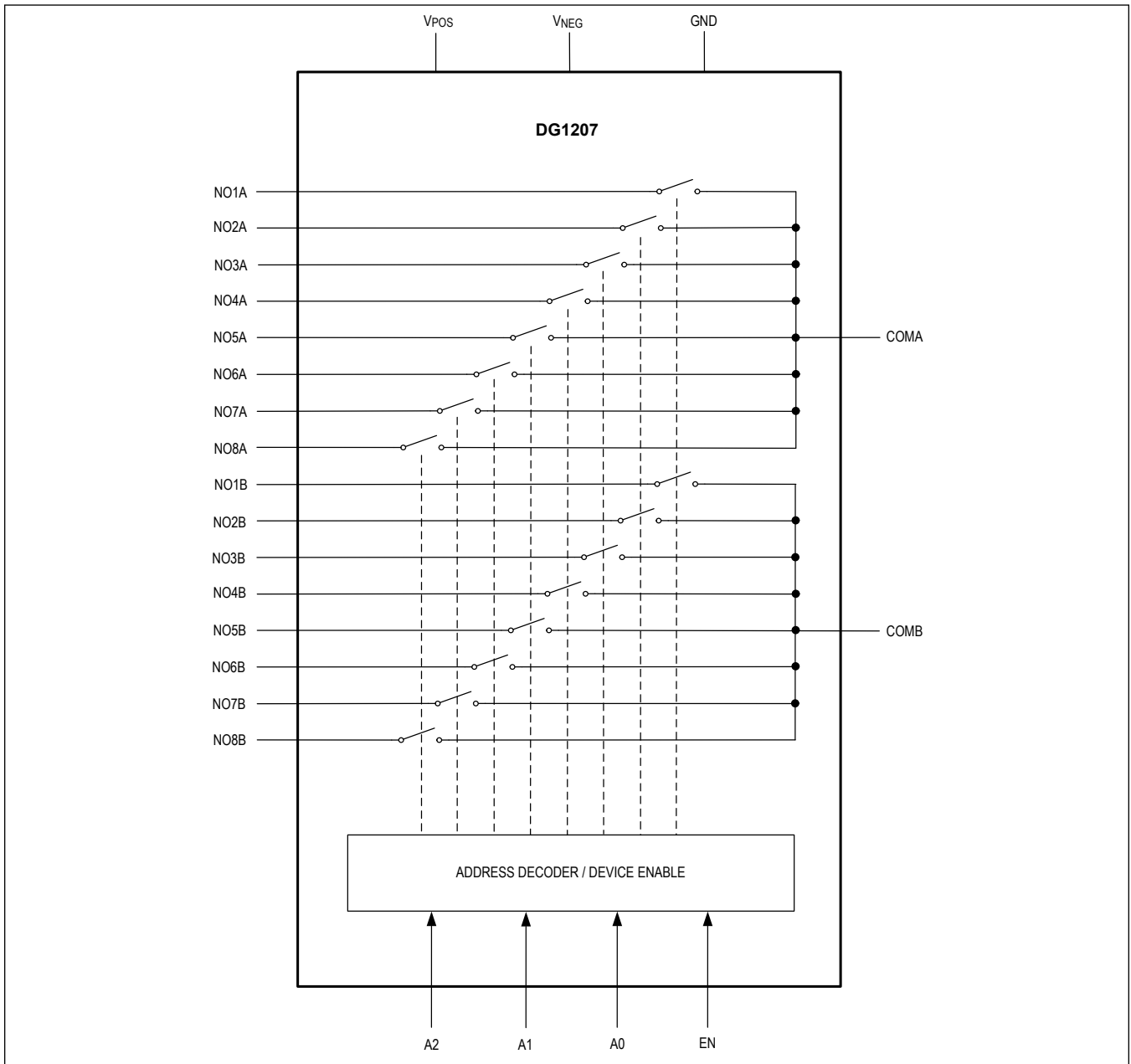

Absolute Maximum Ratings

V _{POS} to GND	-0.3V to +20.5V	Continuous Power Dissipation (28 TSSOP)
V _{NEG} to GND	-20.5V to +0.3V	Single-Layer Board (T _A = +70°C, derate 12.8mW/°C above +70°C).....
V _{POS} to V _{NEG}	-0.3V to +41V 1025.60mW
A ₋ , EN to GND	-0.3V to (V _{POS} + 0.3V)	Multilayer Board (T _A = +70°C, derate 14mW/°C above +70°C).....
NO ₋ , COM ₋ to GND.....	(V _{NEG} - 0.3V) to (V _{POS} + 0.3V) 1117.30mW
Continuous Current Into Any Pin	±30mA	Operating Temperature Range
Continuous Power Dissipation (32 TQFN)	 -40°C to +85°C
Single-Layer Board (T _A = +70°C, derate 21.30mW/°C above +70°C).....	1702.10mW	Junction Temperature
Multilayer Board (T _A = +70°C, derate 34.50mW/°C above +70°C).....	2758.60mW +150°C
		Storage Temperature Range
	 -40°C to +150°C
		Soldering Temperature (reflow)
	 +260°C

Stresses beyond those listed under "Absolute Maximum Ratings" may cause permanent damage to the device. These are stress ratings only, and functional operation of the device at these or any other conditions beyond those indicated in the operational sections of the specifications is not implied. Exposure to absolute maximum rating conditions for extended periods may affect device reliability.

Package Information

32 TQFN

Package Code	T3255+4
Outline Number	21-0140
Land Pattern Number	90-0012
Thermal Resistance, Single-Layer Board:	
Junction to Ambient (θ _{JA})	47°C/W
Junction to Case (θ _{JC})	1.70°C/W
Thermal Resistance, Four-Layer Board:	
Junction to Ambient (θ _{JA})	29°C/W
Junction to Case (θ _{JC})	1.70°C/W

28 TSSOP

Package Code	U28+2
Outline Number	21-0066
Land Pattern Number	90-0171
Thermal Resistance, Single-Layer Board:	
Junction to Ambient (θ _{JA})	78°C/W
Junction to Case (θ _{JC})	13°C/W
Thermal Resistance, Four-Layer Board:	
Junction to Ambient (θ _{JA})	71.6°C/W
Junction to Case (θ _{JC})	13°C/W

For the latest package outline information and land patterns (footprints), go to www.maximintegrated.com/packages. Note that a "+", "#", or "-" in the package code indicates RoHS status only. Package drawings may show a different suffix character, but the drawing pertains to the package regardless of RoHS status.

Package thermal resistances were obtained using the method described in JEDEC specification JESD51-7, using a four-layer board. For detailed information on package thermal considerations, refer to www.maximintegrated.com/thermal-tutorial.

Electrical Characteristics - ±15V Bipolar Supplies

(V_{POS} = +15V, V_{NEG} = -15V, GND = 0V, T_A = -40°C to +85°C, unless otherwise noted.) (Note 1)

PARAMETER	SYMBOL	CONDITIONS	MIN	TYP	MAX	UNITS
POWER SUPPLY						
Positive Power-Supply Voltage	V _{POS}		+5		+20	V
Negative Power-Supply Voltage	V _{NEG}		-20		-5	V
Positive Power-Supply Current	I _{POS}	EN = A ₋ = 0V		40	70	μA
		EN = A ₋ = 2.4V		40	80	
Negative Power-Supply Current	I _{NEG}	EN = A ₋ = 0V	-1		+1	μA
		EN = A ₋ = 2.4V	-1		+1	
ANALOG SWITCH						
Analog-Signal Voltage Range	V _{NO_} , V _{COM_}		V _{NEG}		V _{POS}	V
On-Resistance	R _{ON}	V _{COM_} = 0V, ±5V, ±10V, I _{COM_} = 1mA (Note 2)		100	160	Ω
On-Resistance Match Between Channels	ΔR _{ON}	V _{COM_} = 0V, ±5V, ±10V, I _{COM_} = 1mA (Note 2)		10	30	Ω
On-Resistance Flatness	R _{FLAT}	V _{COM_} = -5V, 0V, +5V, I _{COM_} = 1mA (Note 3)		17	25	Ω
NO_ Off Capacitance	C _{NO_OFF}	V _{NO_} = 0.5V _{P-P} , f = 1MHz		4		pF
COM_ Off Capacitance	C _{COM_OFF}	V _{COM_} = 0.5V _{P-P} , f = 1MHz		15		pF
COM_ On Capacitance	C _{COM_ON}	V _{COM_} = 0.5V _{P-P} , f = 1MHz		10		pF
NO_ Off Leakage Current	I _{NO_OFF}	V _{NO_} = ±10V, V _{COM_} = ∓10V (Note 4)	-1		+1	nA
COM_ Off Leakage Current	I _{COM_OFF}	DG1206, V _{NO_} = +1/+10V, V _{COM_} = +10/+1V (Note 5)	-2		+2	nA
		DG1207, V _{NO_} = +1/+10V, V _{COM_} = +10/+1V (Note 5)	-1		+1	
COM_ On Leakage Current	I _{COM_ON}	DG1206, V _{NO_} = V _{COM_} = ±10V	-2		+2	nA
		DG1207, V _{NO_} = V _{COM_} = ±10V	-1		+1	
DYNAMIC CHARACTERISTICS						
Turn-On Time	t _{ON}	Figure 1 (V _S = 10V)		200	400	ns
Turn-Off Time	t _{OFF}	Figure 1 (V _S = 10V)		300	400	ns
Break-Before-Make Time	t _{BBM}	Figure 2 (V _S = 10V)	50			ns
Total Transition Time	t _{TT}	Figure 3 (V _S = 10V)			400	ns
-3dB Bandwidth	f _{BW}	DG1206, Figure 4 (R _S = R _L = 50Ω)		150		MHz
		DG1207, Figure 4 (R _S = R _L = 50Ω)		200		
Total Harmonic Distortion Plus Noise	THD+N	Figure 5 (f = 20Hz to 20kHz, V _S = 5V _{RMS} , R _S = 50Ω, R _L = 10kΩ)		0.1		%
Off Isolation		Figure 6 (R _S = R _L = 50Ω, V _{NO_} = 0.5V _{P-P} , f = 1MHz)		-80		dB

Electrical Characteristics - ±15V Bipolar Supplies (continued)(V_{POS} = +15V, V_{NEG} = -15V, GND = 0V, T_A = -40°C to +85°C, unless otherwise noted.) (Note 1)

PARAMETER	SYMBOL	CONDITIONS	MIN	TYP	MAX	UNITS
Crosstalk		<i>Figure 7</i> (R _S = R _L = 50Ω, V _{NO_} = 0.5V _{P-P} , f = 1MHz)		-80		dB
DIGITAL INPUTS (A_, EN)						
Input-Logic-High Voltage	V _{IH}		2.4			V
Input-Logic-Low Voltage	V _{IL}				0.8	V
Input-Leakage Current	I _{IN}		-5		+40	μA

Electrical Characteristics - +12V Single Supply(V_{POS} = 12V, V_{NEG} = GND = 0V, T_A = -40°C to +85°C, unless otherwise noted.) (Note 1)

PARAMETER	SYMBOL	CONDITIONS	MIN	TYP	MAX	UNITS
POWER SUPPLY						
Positive Power-Supply Range	V _{POS}	V _{NEG} = GND = 0V	10	12	20	V
Positive Power-Supply Current	I _{POS}	EN = A_ = 0V			70	μA
		EN = A_ = 2.4V			90	
ANALOG SWITCH						
Analog-Signal Voltage Range	V _{NO_} , V _{COM_}		0		V _{POS}	V
On-Resistance	R _{ON}	V _{COM_} = 3V, 6V, 9V, I _{COM_} = 1mA (<i>Note 6</i>)		165	250	Ω
On-Resistance Match Between Channels	ΔR _{ON}	V _{COM_} = 3V, 6V, 9V, I _{COM_} = 1mA (<i>Note 6</i>)		18	50	Ω
On-Resistance Flatness	R _{FLAT}	V _{COM_} = 3V, 6V, 9V, I _{COM_} = 1mA (<i>Note 6</i>)		15	50	Ω
NO_ Off Capacitance	C _{NO_OFF}	V _{NO_} = 0.5V _{P-P} , f = 1MHz		4		pF
COM_ Off Capacitance	C _{COM_OFF}	V _{COM_} = 0.5V _{P-P} , f = 1MHz		15		pF
COM_ On Capacitance	C _{COM_ON}	V _{COM_} = 0.5V _{P-P} , f = 1MHz		10		pF
NO_ Off Leakage Current	I _{NO_OFF}	V _{NO_} = +1V/+10V, V _{COM_} = +10V/+1V (<i>Note 7</i>)	-1		+1	nA
COM_ Off Leakage Current	I _{COM_OFF}	DG1206, V _{NO_} = +1/+10V, V _{COM_} = +10/+1V (<i>Note 7</i>)	-2		+2	nA
		DG1207, V _{NO_} = +1/+10V, V _{COM_} = +10/+1V (<i>Note 7</i>)	-1		+1	
COM_ On Leakage Current	I _{COM_ON}	DG1206, V _{NO_} = V _{COM_} = +1V or +10V	-2		+2	nA
		DG1207, V _{NO_} = V _{COM_} = +1V or +10V	-1		+1	
DYNAMIC CHARACTERISTICS						
Turn-On Time	t _{ON}	<i>Figure 1</i> (V _S = 10V)		400	600	ns
Turn-Off Time	t _{OFF}	<i>Figure 1</i> (V _S = 10V)		250	500	ns
Break-Before-Make Time	t _{BBM}	<i>Figure 2</i> (V _S = 10V)	50			ns

Electrical Characteristics - +12V Single Supply (continued)

(V_{POS} = 12V, V_{NEG} = GND = 0V, T_A = -40°C to +85°C, unless otherwise noted.) (Note 1)

PARAMETER	SYMBOL	CONDITIONS	MIN	TYP	MAX	UNITS
Total Transition Time	t _{TT}	Figure 3 (V _S = 10V)			700	ns
-3dB Bandwidth	f _{BW}	DG1206, Figure 4 (R _S = R _L = 50Ω)		150		MHz
		DG1207, Figure 4 (R _S = R _L = 50Ω)		200		
Total Harmonic Distortion Plus Noise	THD+N	Figure 5 (f = 20Hz to 20kHz, V _S = 5V _{RMS} , R _S = 50Ω, R _L = 10kΩ)		0.1		%
Off-Isolation		Figure 6 (R _S = R _L = 50Ω, V _{NO_} = 0.5V _{P-P} , f = 1MHz)		-80		dB
Crosstalk		Figure 7 (R _S = R _L = 50Ω, V _{NO_} = 0.5V _{P-P} , f = 1MHz)		-80		dB
DIGITAL INPUTS (A_, EN)						
Input-Logic-High Voltage	V _{IH}		2.4			V
Input-Logic-Low Voltage	V _{IL}				0.8	V
Input-Leakage Current	I _{IN}		-5		+30	μA

Note 1: Limits are 100% tested at T_A = +85°C. Limits over the operating temperature range and relevant supply voltage range are guaranteed by design and characterization.

Note 2: On Resistance (R_{ON}) and On-Resistance Match Between Channels (ΔR_{ON}) are measured when the output channel is turned on. The output (COM_) is sourced with 1mA current while biased at one of these levels: 0V, ±5V, or ±10V.

Note 3: On-Resistance Flatness (R_{FLAT}) is measured when the output channel is turned on. The output (COM_) is sourced with 1mA current while biased at one of these levels: -5V, 0V, or +5V.

Note 4: NO_ Off-Leakage Current (I_{NO_OFF}) is measured when the output channel is switched off while the input (NO_) is biased at +10V and output (COM_) at -10V, or while the input is biased at -10V and output at +10V.

Note 5: COM_ Off-Leakage Current (I_{COM_OFF}) is measured when the output channel is switched off while the input (NO_) is biased at +1V and output (COM_) at +10V, or while the input is biased at +10V and output at +1V.

Note 6: On Resistance (R_{ON}), On-Resistance Match Between Channels (ΔR_{ON}), and On-Resistance Flatness (R_{FLAT}) are measured when the output channel is turned on. The output (COM_) is sourced with 1mA current while biased at one of these levels: 3V, 6V, or 9V.

Note 7: NO_ Off-Leakage Current (I_{NO_OFF}) and COM_ Off-Leakage Current (I_{COM_OFF}) are measured when the output channel is switched off while the input (NO_) is biased at +1V and output (COM_) at +10V, or while the input is biased at +10V and output at +1V.

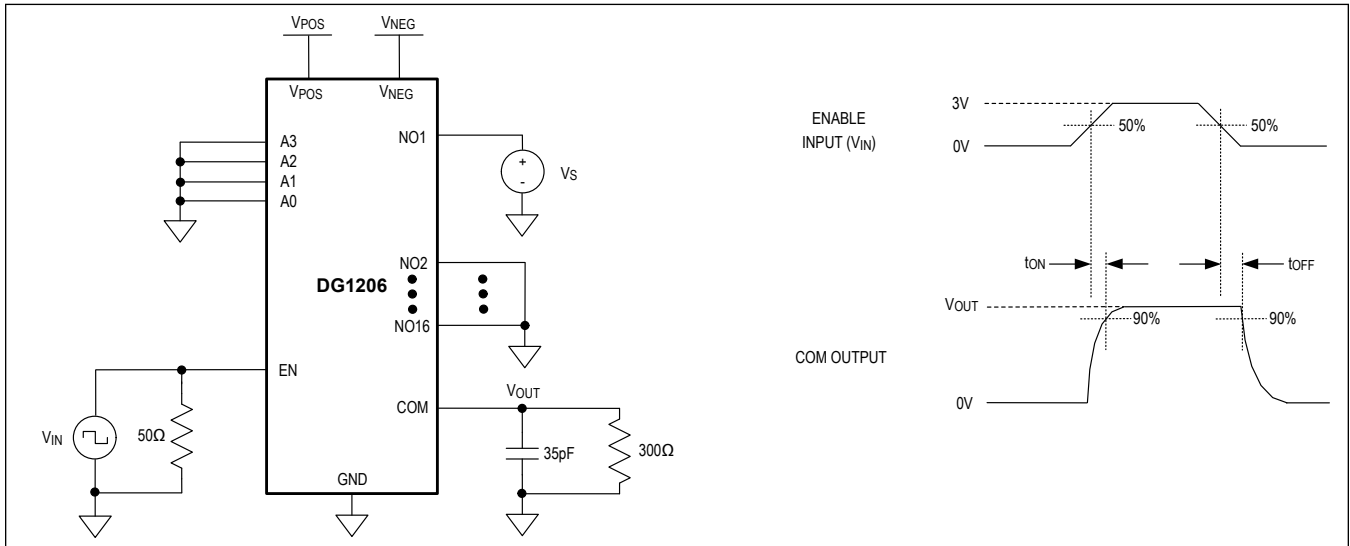

Figure 1. Turn-On Time and Turn-Off Time (Similar Connection for DG1207)

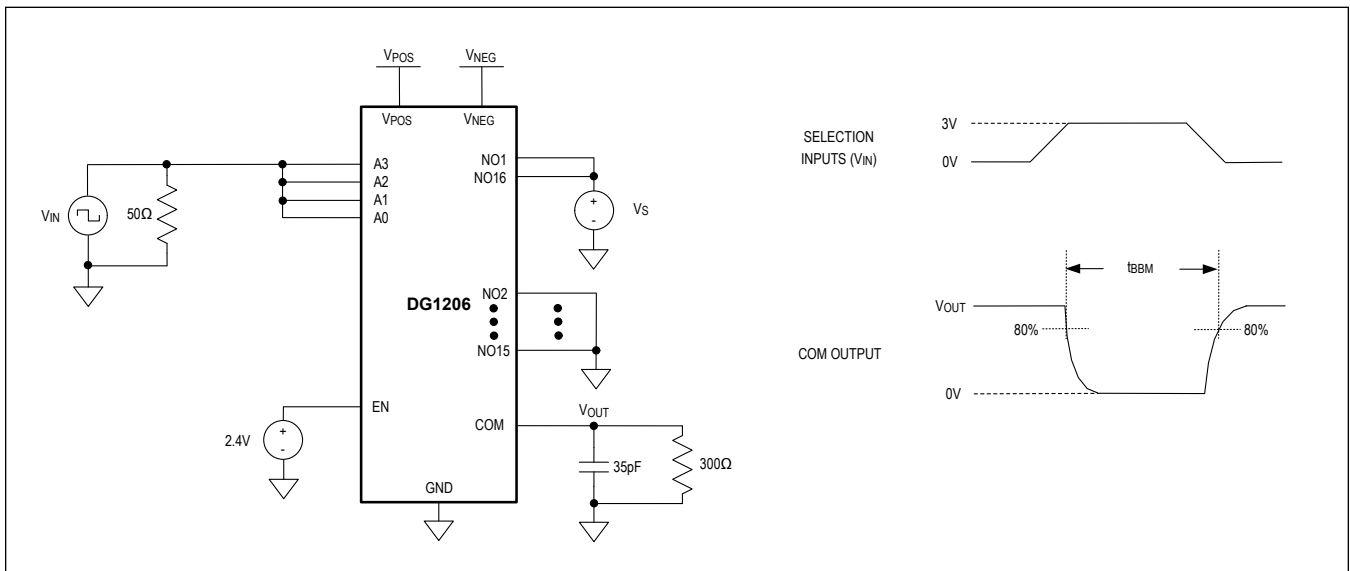

Figure 2. Break-Before-Make Time (Similar Connection for DG1207)

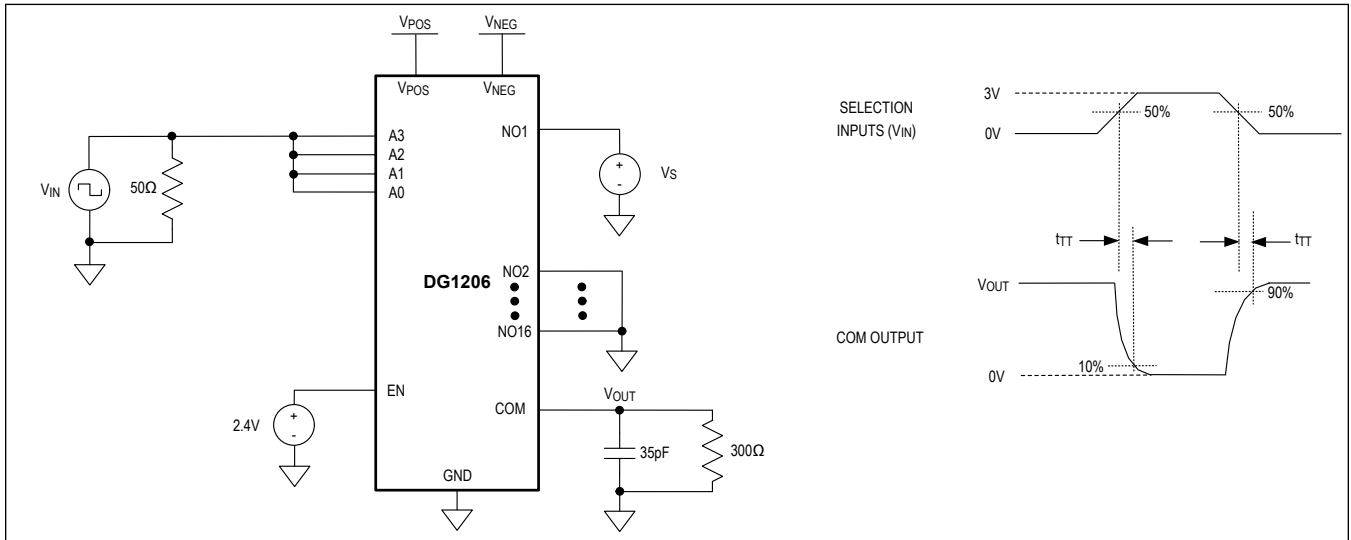

Figure 3. Total Transition Time (Similar Connection for DG1207)

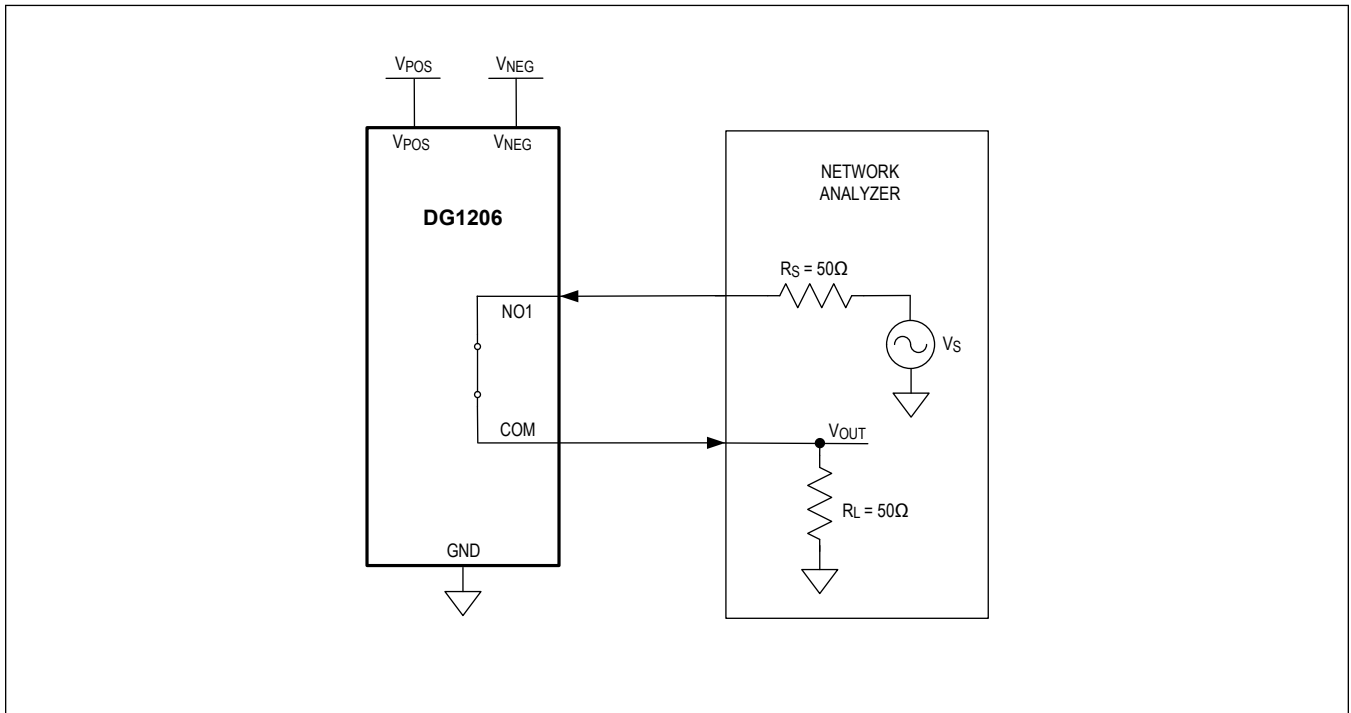

Figure 4. -3dB Bandwidth (Similar Connection for DG1207)

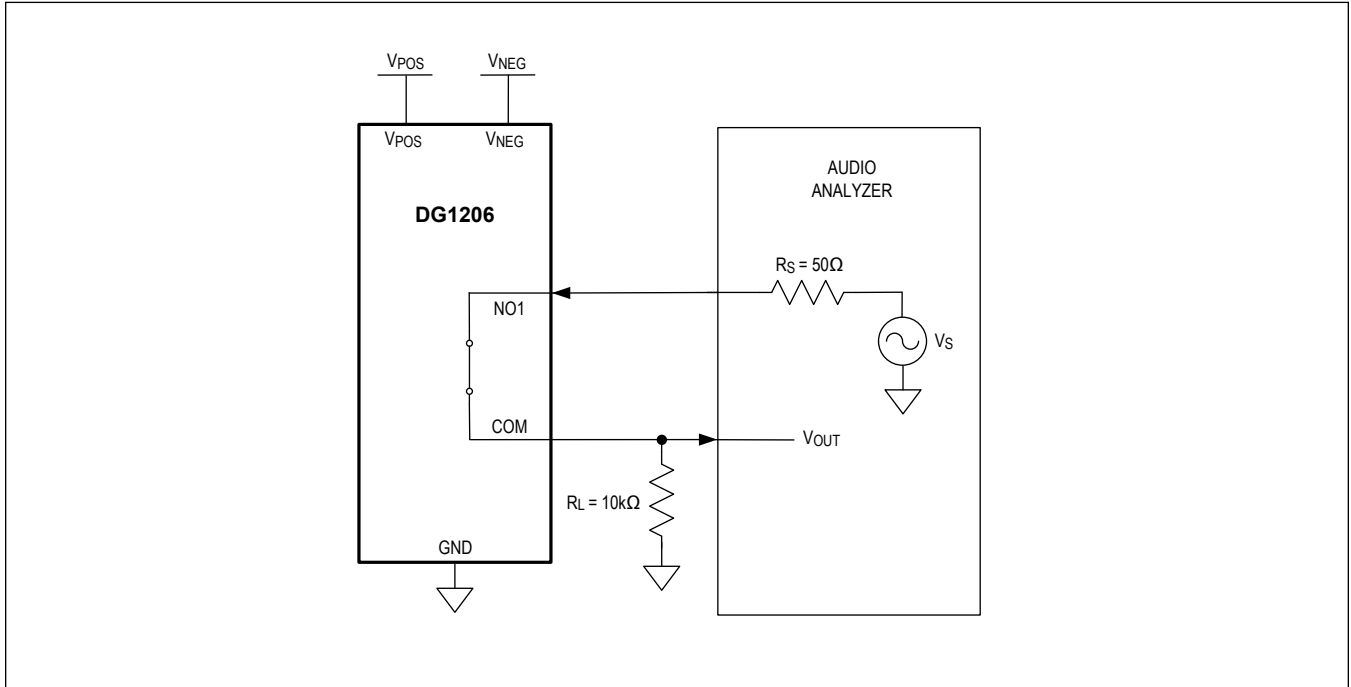

Figure 5. Total Harmonic Distortion Plus Noise (Similar Connection for DG1207)

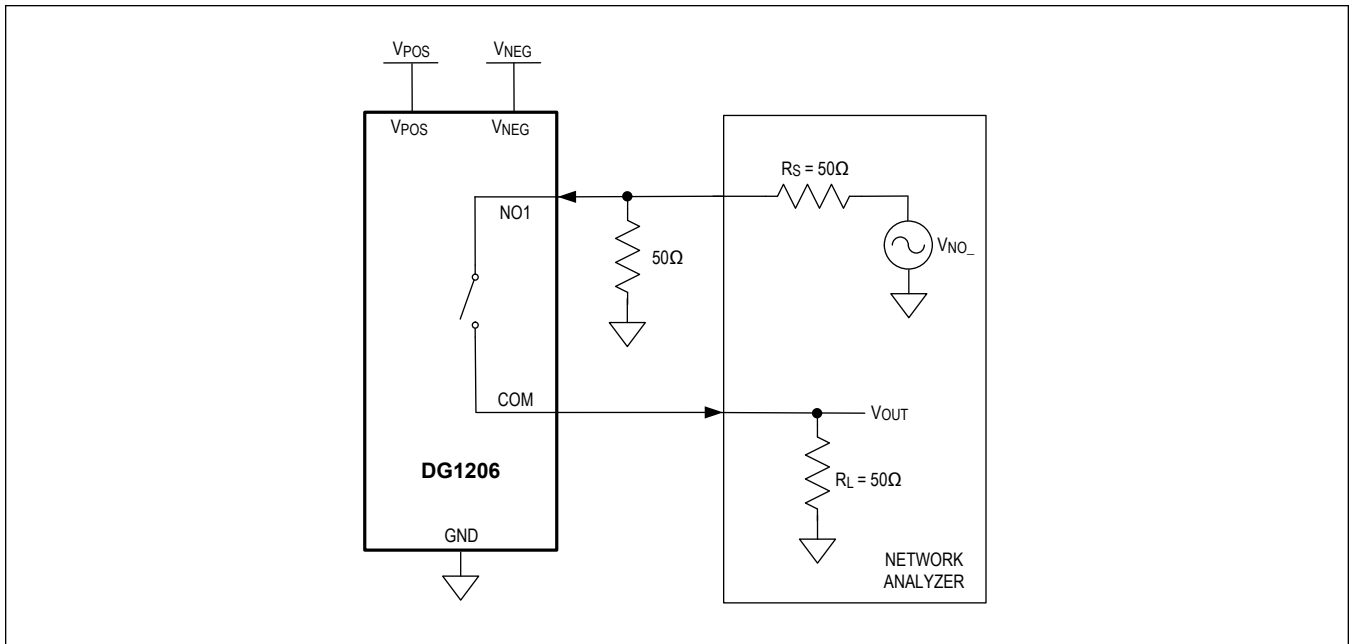

Figure 6. Off-Isolation (Similar Connection for DG1207)

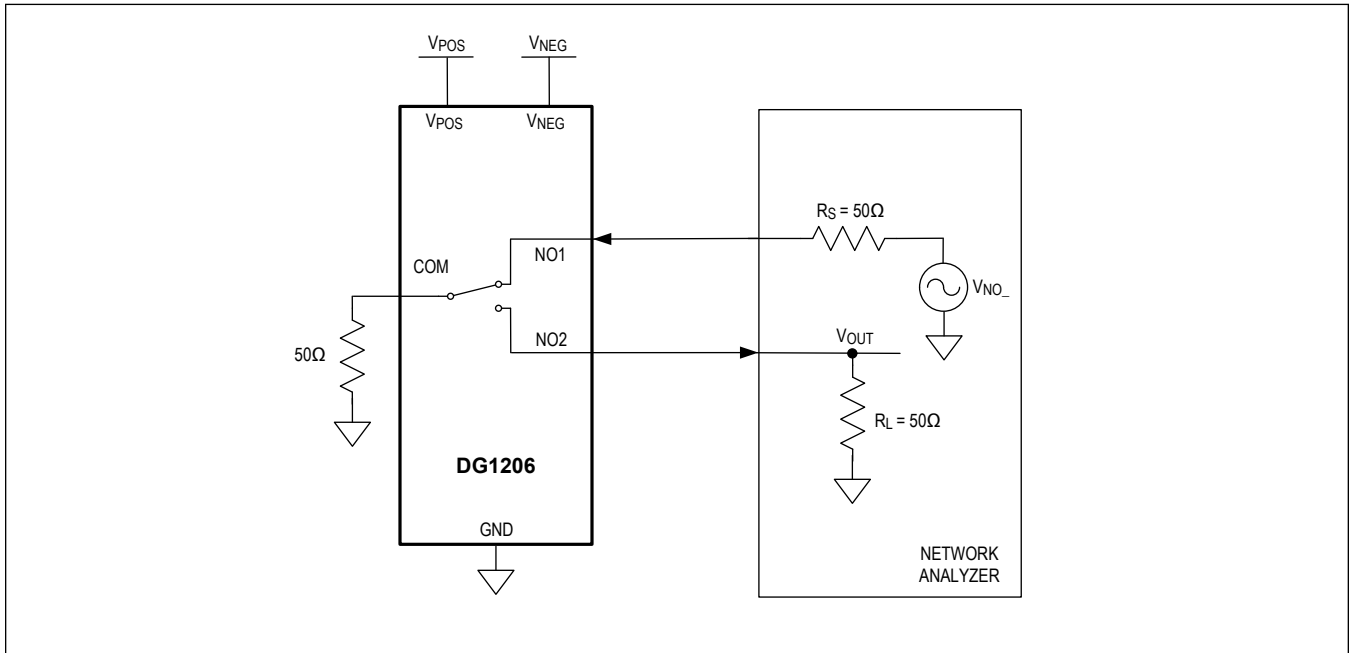
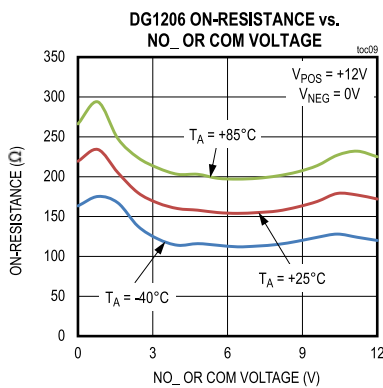
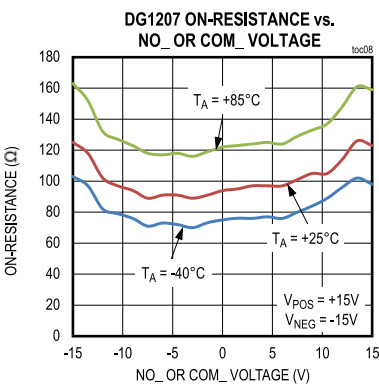
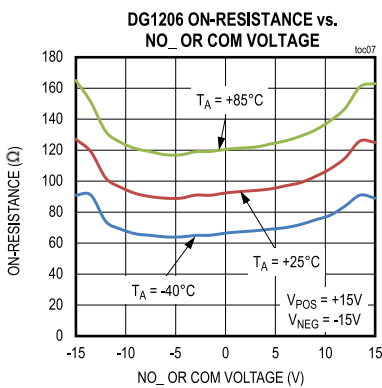
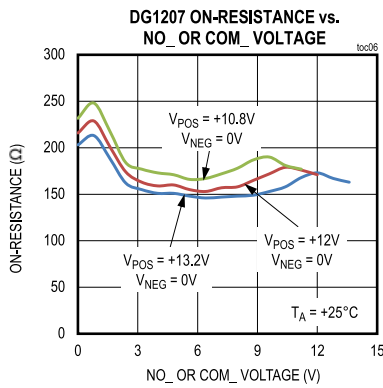
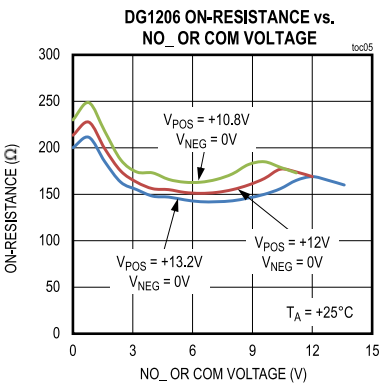
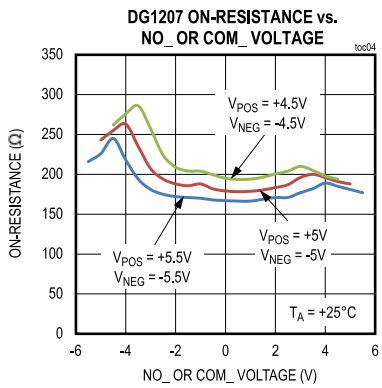
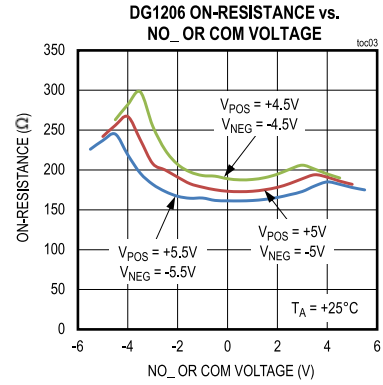
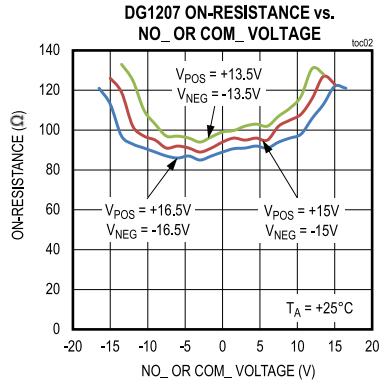
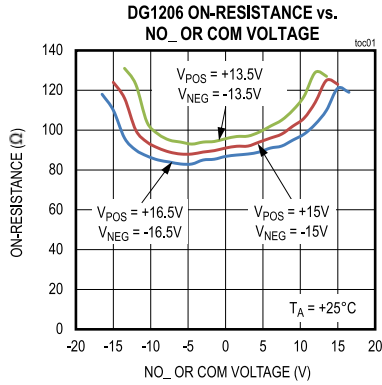

Figure 7. Crosstalk (Similar Connection for DG1207)

Typical Operating Characteristics

($T_A = 25^\circ\text{C}$, unless otherwise noted.)



Typical Operating Characteristics (continued)

($T_A = 25^\circ\text{C}$, unless otherwise noted.)

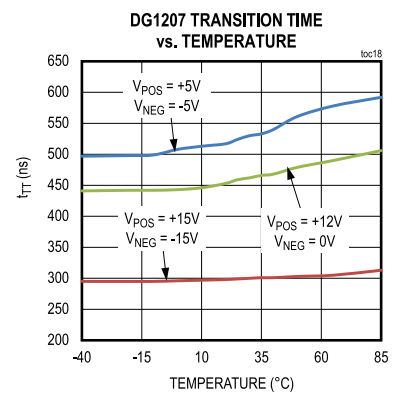
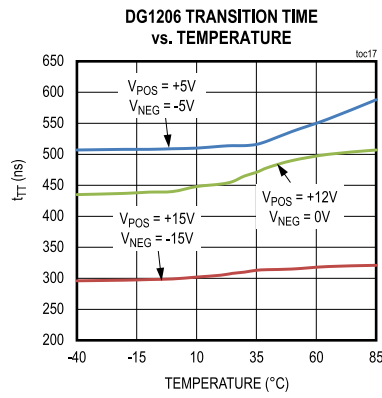
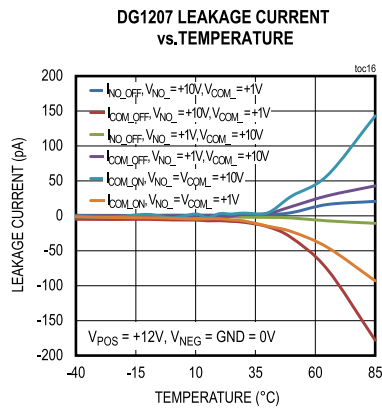
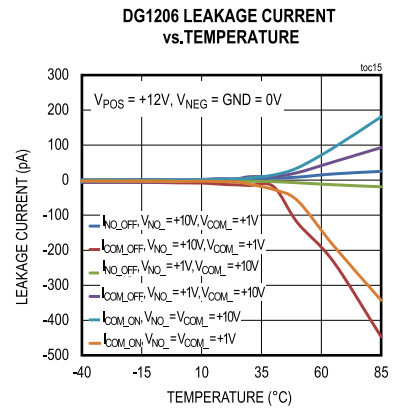
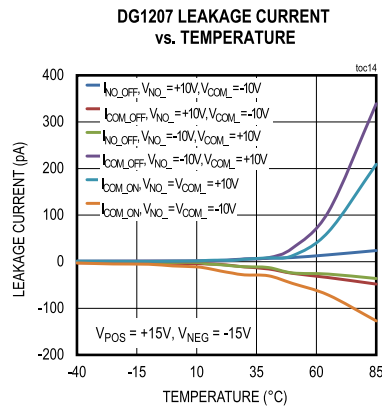
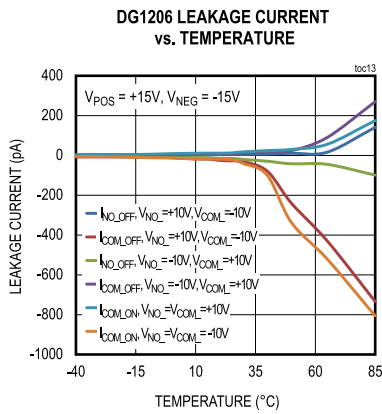
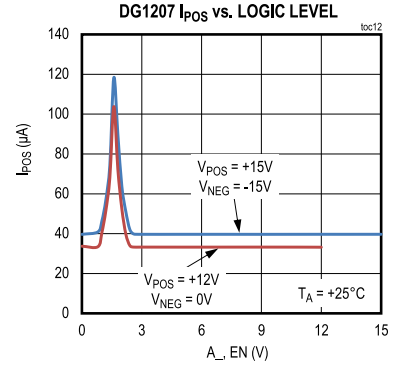
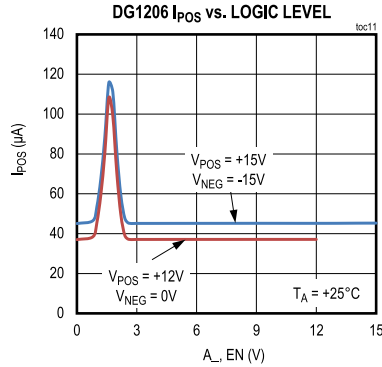
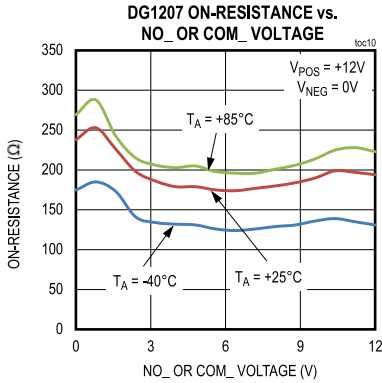

Typical Operating Characteristics (continued)

(T_A = 25°C, unless otherwise noted.)

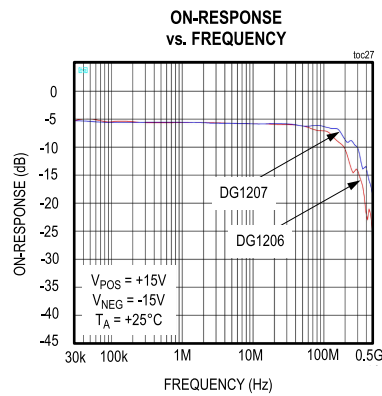
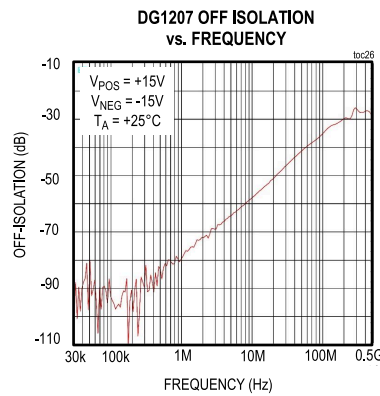
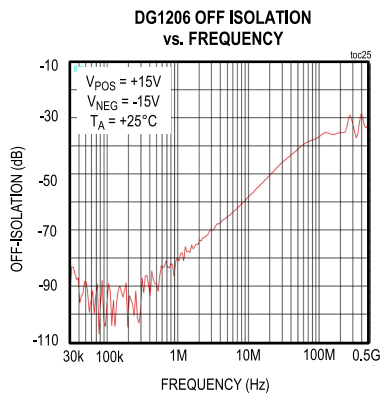
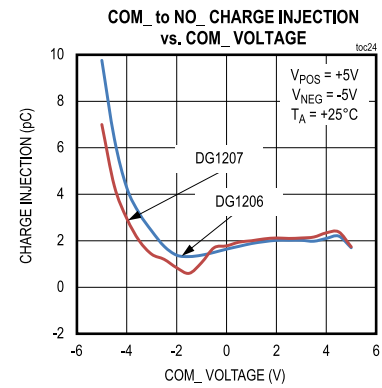
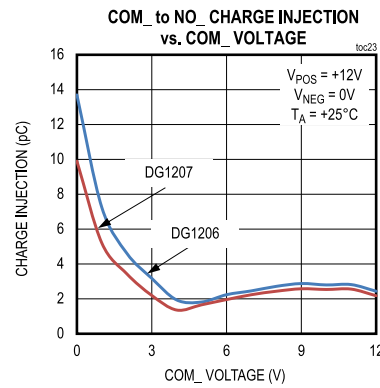
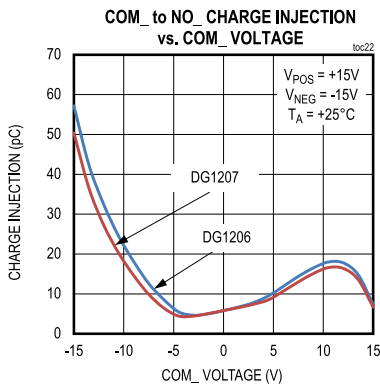
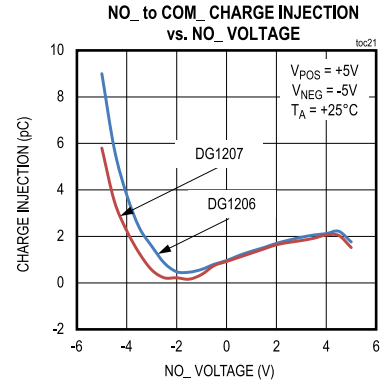
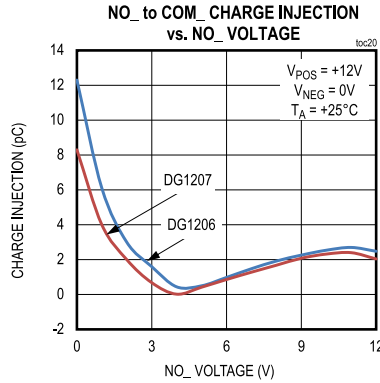
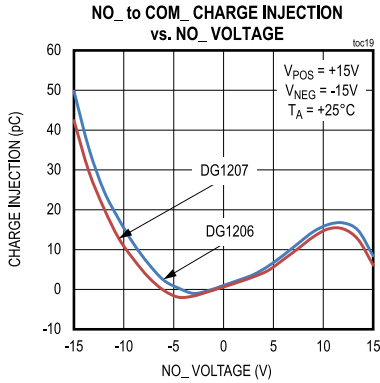

Typical Operating Characteristics (continued)

($T_A = 25^\circ\text{C}$, unless otherwise noted.)

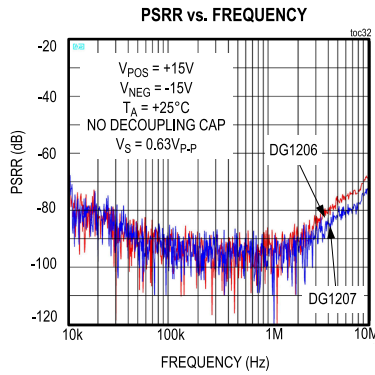
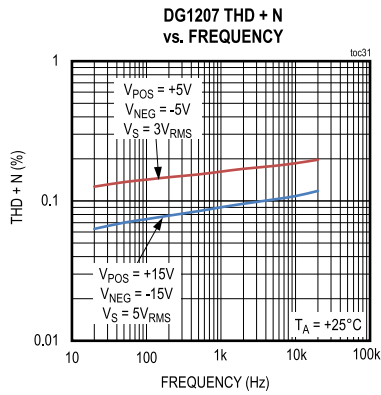
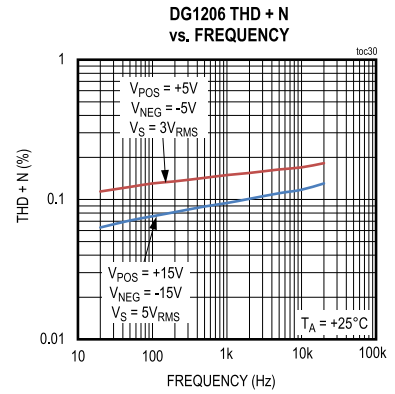
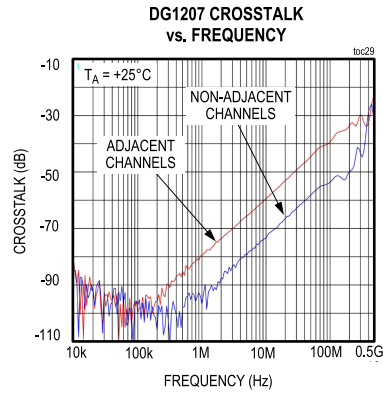
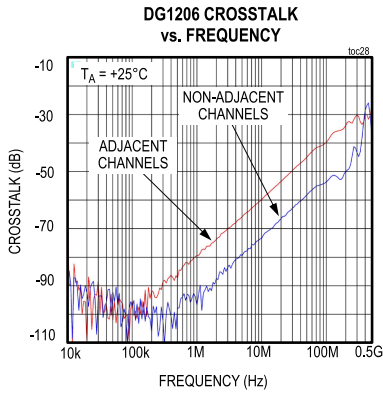

Pin Configurations

DG1206ETJ+

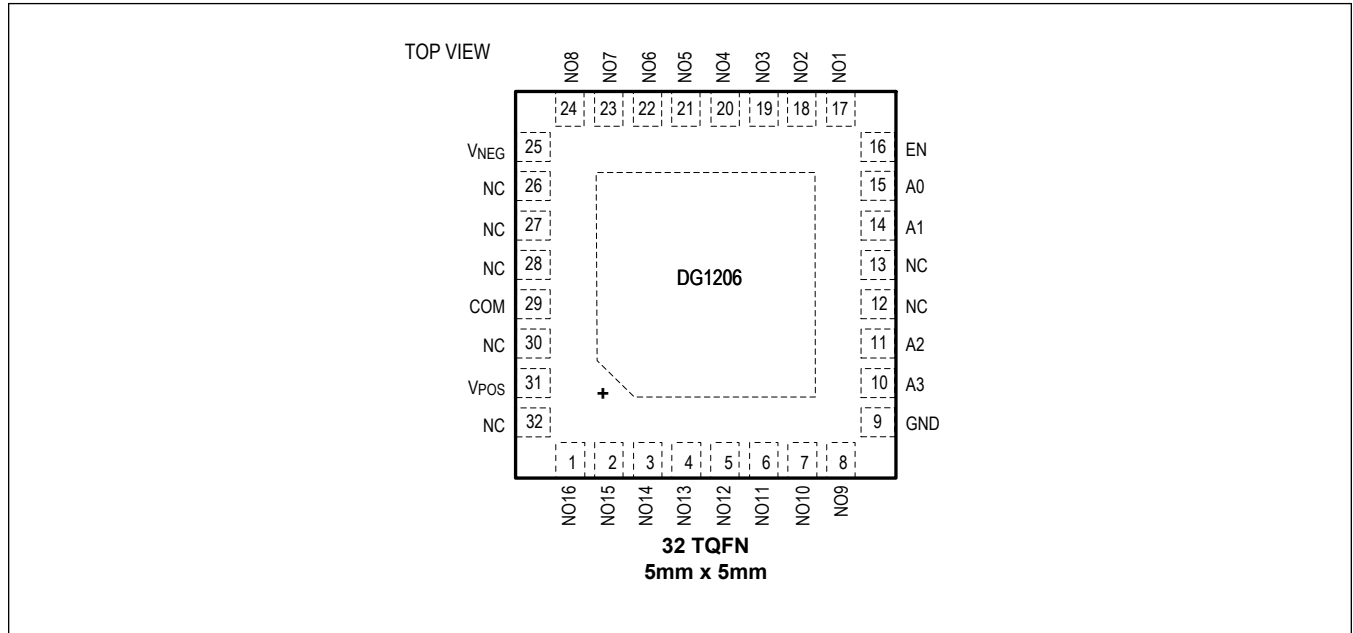

DG1206EUI+

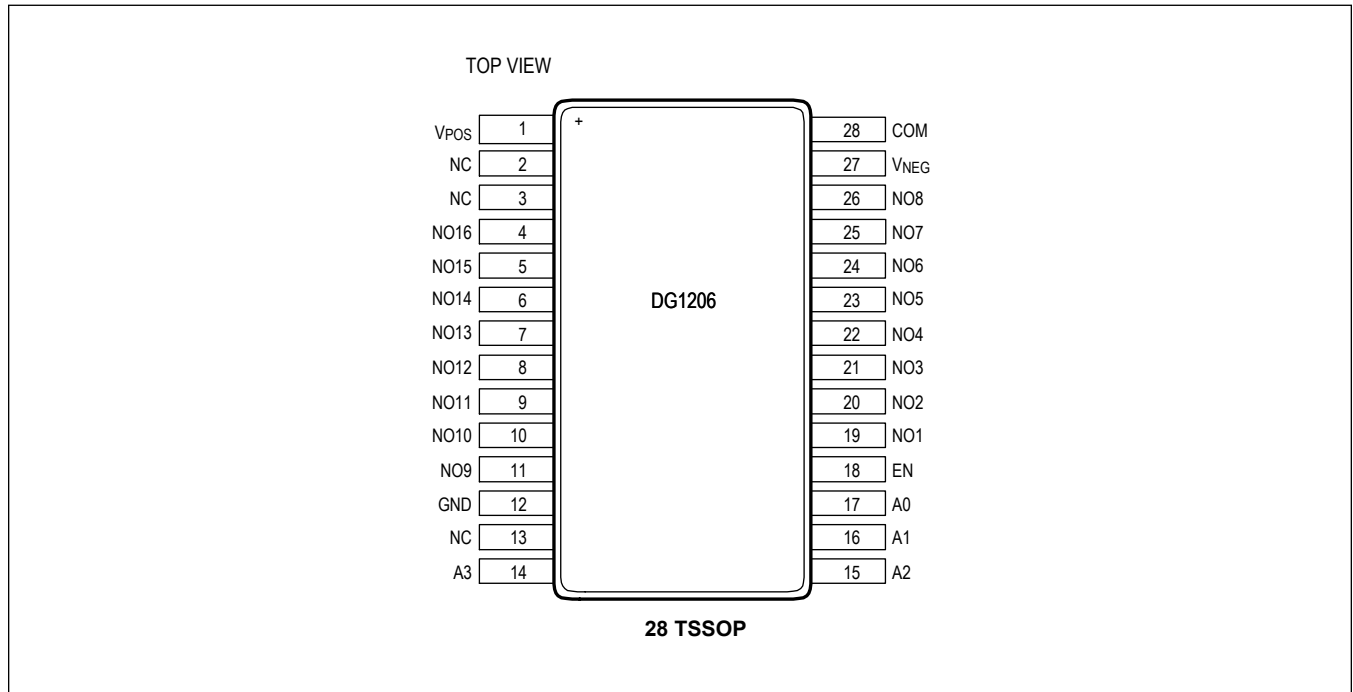

Pin Description

PIN		NAME	FUNCTION
DG1206ETJ+	DG1206EUI+		
POWER SUPPLY			
31	1	V _{POS}	Positive Power Supply. Bypass V _{POS} to GND with a minimum 0.1µF ceramic capacitor as close to the pin as possible.
25	27	V _{NEG}	Negative Power Supply. Bypass V _{NEG} to GND with a minimum 0.1µF ceramic capacitor as close to the pin as possible. In single-supply applications, connect V _{NEG} to GND.
9	12	GND	Logic Ground Reference
12, 13, 26, 27, 28, 30, 32	2, 3, 13	NC	Not Connected
DIGITAL INPUTS			
10	14	A3	Logic-Address Input. See the Control Logic section for more information.
11	15	A2	Logic-Address Input. See the Control Logic section for more information.
14	16	A1	Logic-Address Input. See the Control Logic section for more information.
15	17	A0	Logic-Address Input. See the Control Logic section for more information.
16	18	EN	Enable Input. Drive EN high to enable the multiplexer. Drive EN low to disable all switches. Do not leave EN unconnected.
ANALOG SWITCH			
29	28	COM	Common Bidirectional Analog-Signal Terminal. It can be either an input or output.
1	4	NO16	Normally-Open Bidirectional Analog-Signal Terminal. It can be either an input or output.
2	5	NO15	Normally-Open Bidirectional Analog-Signal Terminal. It can be either an input or output.
3	6	NO14	Normally-Open Bidirectional Analog-Signal Terminal. It can be either an input or output.
4	7	NO13	Normally-Open Bidirectional Analog-Signal Terminal. It can be either an input or output.
5	8	NO12	Normally-Open Bidirectional Analog-Signal Terminal. It can be either an input or output.
6	9	NO11	Normally-Open Bidirectional Analog-Signal Terminal. It can be either an input or output.
7	10	NO10	Normally-Open Bidirectional Analog-Signal Terminal. It can be either an input or output.
8	11	NO9	Normally-Open Bidirectional Analog-Signal Terminal. It can be either an input or output.
24	26	NO8	Normally-Open Bidirectional Analog-Signal Terminal. It can be either an input or output.
23	25	NO7	Normally-Open Bidirectional Analog-Signal Terminal. It can be either an input or output.
22	24	NO6	Normally-Open Bidirectional Analog-Signal Terminal. It can be either an input or output.
21	23	NO5	Normally-Open Bidirectional Analog-Signal Terminal. It can be either an input or output.

Pin Description (continued)

PIN		NAME	FUNCTION
DG1206ETJ+	DG1206EUI+		
20	22	NO4	Normally-Open Bidirectional Analog-Signal Terminal. It can be either an input or output.
19	21	NO3	Normally-Open Bidirectional Analog-Signal Terminal. It can be either an input or output.
18	20	NO2	Normally-Open Bidirectional Analog-Signal Terminal. It can be either an input or output.
17	19	NO1	Normally-Open Bidirectional Analog-Signal Terminal. It can be either an input or output.

Pin Configurations

DG1207ETJ+

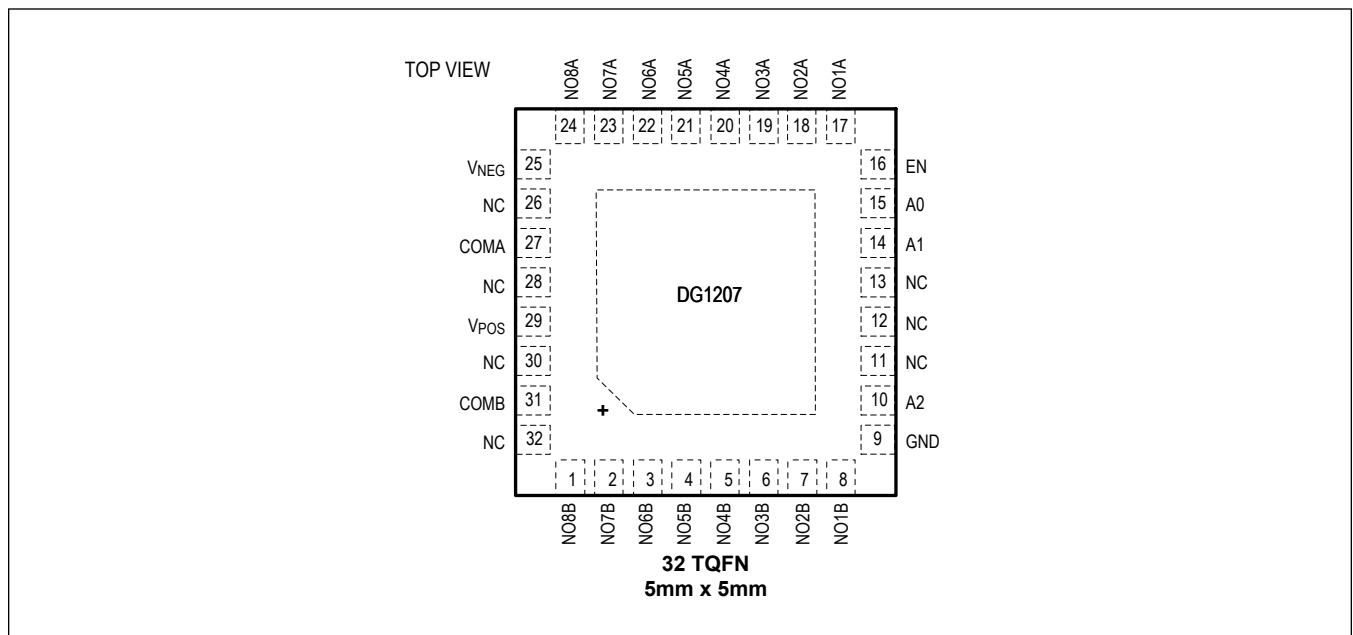

DG1207EUI+

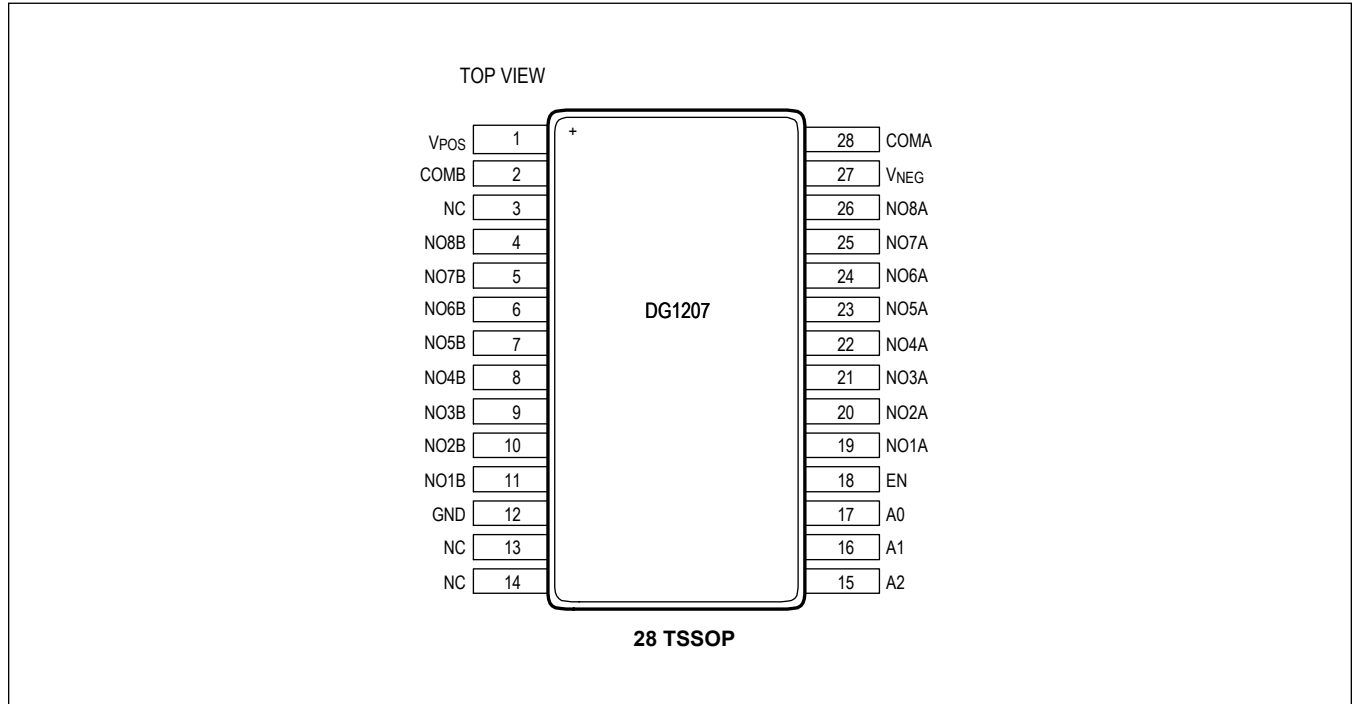

Pin Description

PIN		NAME	FUNCTION
DG1207ETJ+	DG1207EUI+		
POWER SUPPLY			
29	1	V _{POS}	Positive Power Supply. Bypass V _{POS} to GND with a minimum 0.1µF ceramic capacitor as close to the pin as possible.
25	27	V _{NEG}	Negative Power Supply. Bypass V _{NEG} to GND with a minimum 0.1µF ceramic capacitor as close to the pin as possible. In single-supply applications, connect V _{NEG} to GND.
9	12	GND	Logic Ground Reference
11, 12, 13, 26, 28, 30, 32	3, 13, 14	NC	Not Connected
DIGITAL INPUTS			
10	15	A2	Logic-Address Input. See the Control Logic section for more information.
14	16	A1	Logic-Address Input. See the Control Logic section for more information.
15	17	A0	Logic-Address Input. See the Control Logic section for more information.
16	18	EN	Enable Input. Drive EN high to enable the multiplexer. Drive EN low to disable all switches. Do not leave EN unconnected.
ANALOG SWITCH			
31	2	COMB	B-Side Common Bidirectional Analog-Signal Terminal. It can be either an input or output.
27	28	COMA	A-Side Common Bidirectional Analog-Signal Terminal. It can be either an input or output.

Pin Description (continued)

PIN		NAME	FUNCTION
DG1207ETJ+	DG1207EUI+		
1	4	NO8B	B-Side Normally-Open Bidirectional Analog-Signal Terminal. It can be either an input or output.
2	5	NO7B	B-Side Normally-Open Bidirectional Analog-Signal Terminal. It can be either an input or output.
3	6	NO6B	B-Side Normally-Open Bidirectional Analog-Signal Terminal. It can be either an input or output.
4	7	NO5B	B-Side Normally-Open Bidirectional Analog-Signal Terminal. It can be either an input or output.
5	8	NO4B	B-Side Normally-Open Bidirectional Analog-Signal Terminal. It can be either an input or output.
6	9	NO3B	B-Side Normally-Open Bidirectional Analog-Signal Terminal. It can be either an input or output.
7	10	NO2B	B-Side Normally-Open Bidirectional Analog-Signal Terminal. It can be either an input or output.
8	11	NO1B	B-Side Normally-Open Bidirectional Analog-Signal Terminal. It can be either an input or output.
24	26	NO8A	A-Side Normally-Open Bidirectional Analog-Signal Terminal. It can be either an input or output.
23	25	NO7A	A-Side Normally-Open Bidirectional Analog-Signal Terminal. It can be either an input or output.
22	24	NO6A	A-Side Normally-Open Bidirectional Analog-Signal Terminal. It can be either an input or output.
21	23	NO5A	A-Side Normally-Open Bidirectional Analog-Signal Terminal. It can be either an input or output.
20	22	NO4A	A-Side Normally-Open Bidirectional Analog-Signal Terminal. It can be either an input or output.
19	21	NO3A	A-Side Normally-Open Bidirectional Analog-Signal Terminal. It can be either an input or output.
18	20	NO2A	A-Side Normally-Open Bidirectional Analog-Signal Terminal. It can be either an input or output.
17	19	NO1A	A-Side Normally-Open Bidirectional Analog-Signal Terminal. It can be either an input or output.

Detailed Description

The DG1206/DG1207 are single 16-channel or dual 8-channel multiplexing switch devices with low-leakage and low-charge injection. The ultra-low capacitance and low-charge injection of the DG1206/DG1207 make them ideal for automatic test equipment systems, data acquisition systems, sample-and-hold systems, and communication systems where low glitch and fast settling time are required.

The DG1206 is a single 16-channel multiplexer. It switches one of the 16 NO₊ inputs to a common output COM, as determined by the four selection inputs A3, A2, A1, and A0. The DG1207 is a dual 8-channel multiplexer. It switches a pair of differential NO₊ inputs to differential outputs COMA and COMB, as determined by the three selection inputs A2, A1, and A0. See the [Control Logic](#) section for more information.

The DG1206/DG1207 operate rail-to-rail and are fully specified for ±15V bipolar supplies or +12V single supply. The EN input on DG1206/DG1207 is used to enable or disable the device. When EN is low, all channels are switched off. When EN is high, each channel conducts bidirectionally according to the selection inputs.

Control Logic

The DG1206 uses four selection inputs A3, A2, A1, and A0 to determine the switching logic.

Table 1. DG1206 Control Logic

A3	A2	A1	A0	EN	SWITCH ON
X	X	X	X	0	Switch Off
0	0	0	0	1	1
0	0	0	1	1	2
0	0	1	0	1	3
0	0	1	1	1	4
0	1	0	0	1	5
0	1	0	1	1	6
0	1	1	0	1	7
0	1	1	1	1	8
1	0	0	0	1	9
1	0	0	1	1	10
1	0	1	0	1	11
1	0	1	1	1	12
1	1	0	0	1	13
1	1	0	1	1	14
1	1	1	0	1	15
1	1	1	1	1	16

The DG1207 uses three selection inputs A2, A1, and A0 to determine the switching logic.

Table 2. DG1207 Control Logic

A2	A1	A0	EN	SWITCH ON
X	X	X	0	Switch Off
0	0	0	1	1A, 1B
0	0	1	1	2A, 2B
0	1	0	1	3A, 3B
0	1	1	1	4A, 4B

Table 2. DG1207 Control Logic (continued)

A2	A1	A0	EN	SWITCH ON
1	0	0	1	5A, 5B
1	0	1	1	6A, 6B
1	1	0	1	7A, 7B
1	1	1	1	8A, 8B

Typical Application Circuits

Data Acquisition System with DG1206 Using Bipolar Supplies

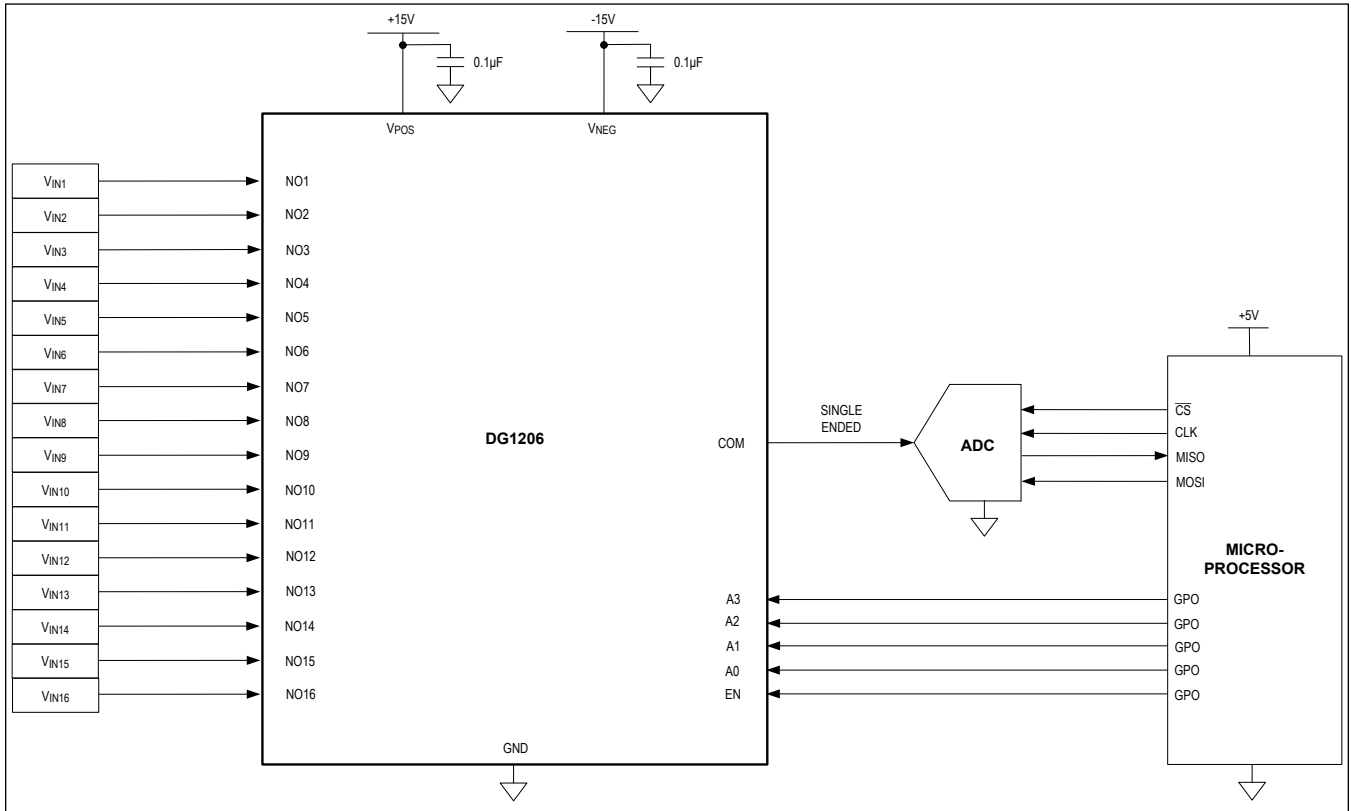

Typical Application Circuits (continued)

Data Acquisition System with DG1207 Using Single Supply

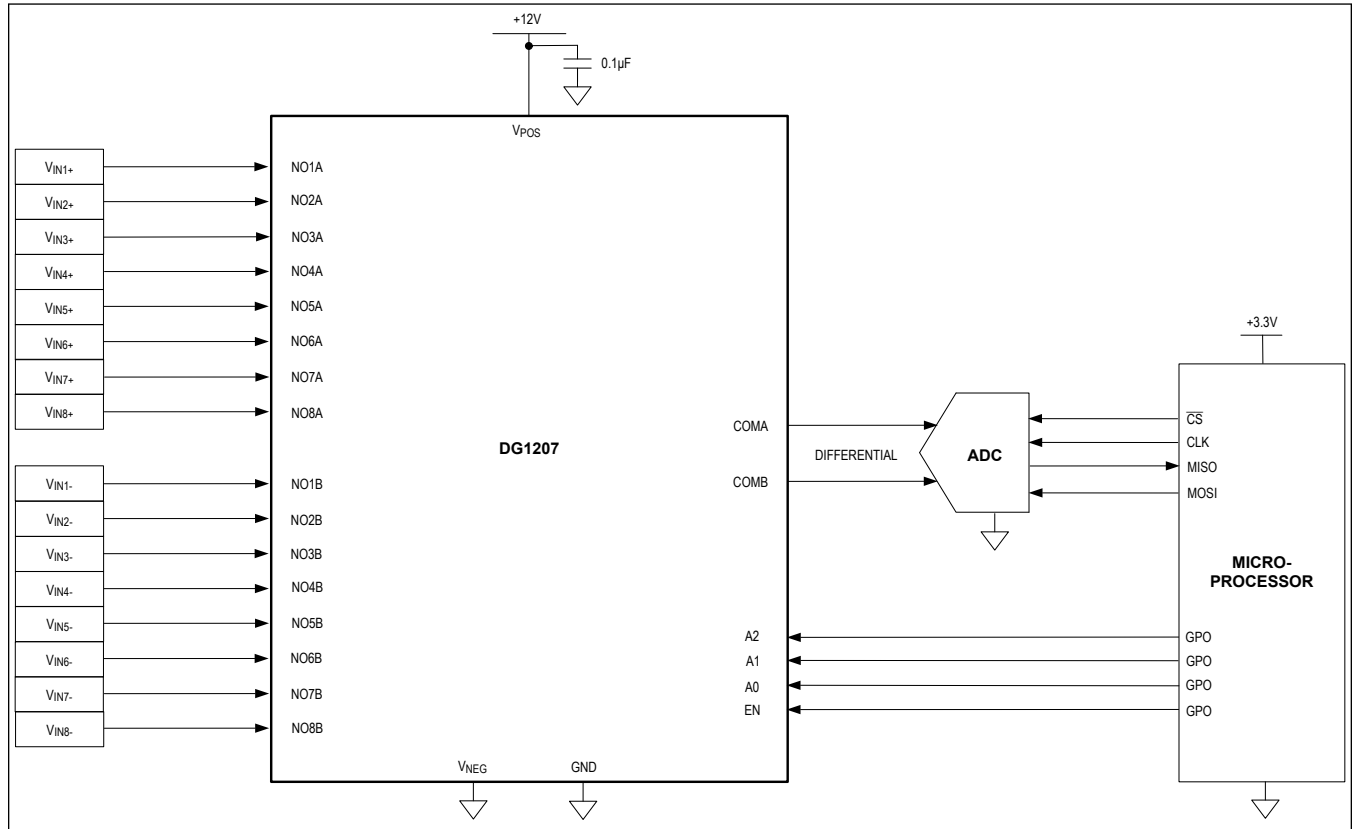

Ordering Information

PART NUMBER	PIN-PACKAGE	TEMPERATURE
DG1206ETJ+*	32 TQFN	-40°C to +85°C
DG1206EUI+	28 TSSOP	-40°C to +85°C
DG1207ETJ+*	32 TQFN	-40°C to +85°C
DG1207EUI+	28 TSSOP	-40°C to +85°C

+ Denotes a lead(Pb)-free/RoHS-compliant package.

*Future products—contact factory for availability.

Revision History

REVISION NUMBER	REVISION DATE	DESCRIPTION	PAGES CHANGED
0	6/20	Initial Release	—

For pricing, delivery, and ordering information, please visit Maxim Integrated's online storefront at <https://www.maximintegrated.com/en/storefront/storefront.html>.

Maxim Integrated cannot assume responsibility for use of any circuitry other than circuitry entirely embodied in a Maxim Integrated product. No circuit patent licenses are implied. Maxim Integrated reserves the right to change the circuitry and specifications without notice at any time. The parametric values (min and max limits) shown in the Electrical Characteristics table are guaranteed. Other parametric values quoted in this data sheet are provided for guidance.