

## 1A, 200V - 1000V Fast Recovery Surface Mount Rectifier

### FEATURES

- Glass passivated chip junction
- Ideal for automated placement
- Low profile package
- Low power loss, high efficiency
- Moisture sensitivity level: level 1, per J-STD-020
- RoHS Compliant
- Halogen-free according to IEC 61249-2-21

### APPLICATIONS

- DC to DC converter
- Switching mode converters and inverters
- General purpose

### MECHANICAL DATA

- Case: SOD-123W
- Molding compound meets UL 94V-0 flammability rating
- Terminal: Matte tin plated leads, solderable per J-STD-002
- Meet JESD 201 class 2 whisker test
- Polarity: Indicated by cathode band
- Weight: 0.016g (approximately)

KEY PARAMETERS		
PARAMETER	VALUE	UNIT
$I_F$	1	A
$V_{RRM}$	200 - 1000	V
$I_{FSM}$	30	A
$T_{J\ MAX}$	175	°C
Package	SOD-123W	
Configuration	Single die	



SOD-123W



ABSOLUTE MAXIMUM RATINGS ( $T_A = 25^\circ\text{C}$ unless otherwise noted)							
PARAMETER	SYMBOL	RS1DLW	RS1GLW	RS1JLW	RS1KLW	RS1MLW	UNIT
Marking code on the device		RDLW	RGLW	RJLW	RKLW	RMLW	
Repetitive peak reverse voltage	$V_{RRM}$	200	400	600	800	1000	V
Reverse voltage, total rms value	$V_{R(RMS)}$	140	280	420	560	700	V
Forward current	$I_F$	1					A
Peak forward surge current, 8.3ms single half sine-wave superimposed on rated load	$I_{FSM}$	30					A
Junction temperature	$T_J$	- 55 to +175					°C
Storage temperature	$T_{STG}$	- 55 to +175					°C

**THERMAL PERFORMANCE**

PARAMETER	SYMBOL	TYP	UNIT
Junction-to-lead thermal resistance	$R_{\theta JL}$	25	°C/W
Junction-to-ambient thermal resistance	$R_{\theta JA}$	80	°C/W

**ELECTRICAL SPECIFICATIONS** ( $T_A = 25^\circ\text{C}$  unless otherwise noted)

PARAMETER	CONDITIONS	SYMBOL	TYP	MAX	UNIT
Forward voltage <sup>(1)</sup>	$I_F = 1\text{A}, T_J = 25^\circ\text{C}$	$V_F$	-	1.3	V
Reverse current @ rated $V_R$ <sup>(2)</sup>	$T_J = 25^\circ\text{C}$	$I_R$	-	5	$\mu\text{A}$
	$T_J = 125^\circ\text{C}$		-	150	$\mu\text{A}$
Reverse recovery time	$I_F = 0.5\text{A}, I_R = 1.0\text{A}, I_{rr} = 0.25\text{A}$	$t_{rr}$	-	150	ns
			-	250	ns

**Notes:**

1. Pulse test with  $PW = 0.3\text{ms}$
2. Pulse test with  $PW = 30\text{ms}$

**ORDERING INFORMATION**

ORDERING CODE <sup>(1)</sup>	PACKAGE	PACKING
RS1xLW	SOD-123W	10,000 / Tape & Reel

**Notes:**

1. "x" defines voltage from 200V(RS1DLW) to 1000V(RS1MLW)

**CHARACTERISTICS CURVES**

( $T_A = 25^\circ\text{C}$  unless otherwise noted)

**Fig.1 Forward Current Derating Curve**

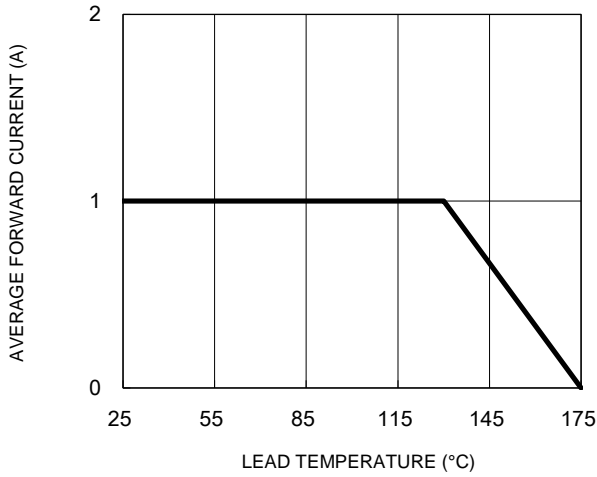

**Fig.2 Typical Junction Capacitance**

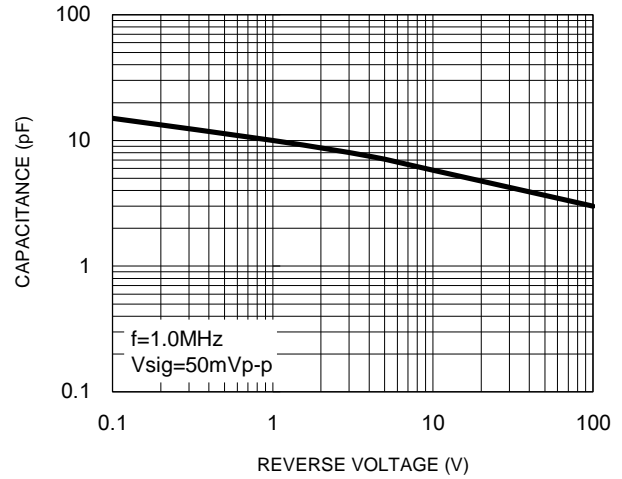

**Fig.3 Typical Reverse Characteristics**

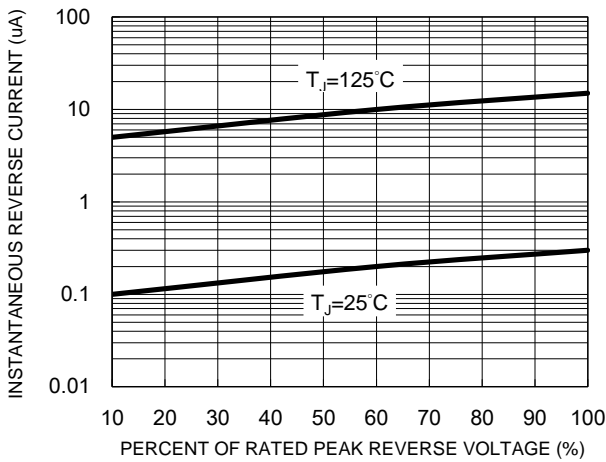

**Fig.4 Typical Forward Characteristics**

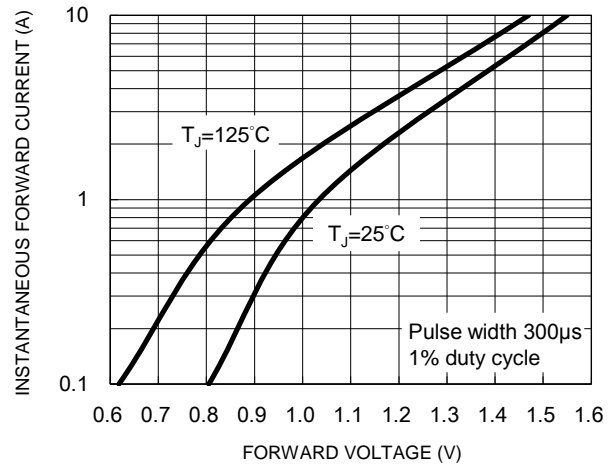

**Fig.5 Maximum Non-Repetitive Forward Surge Current**

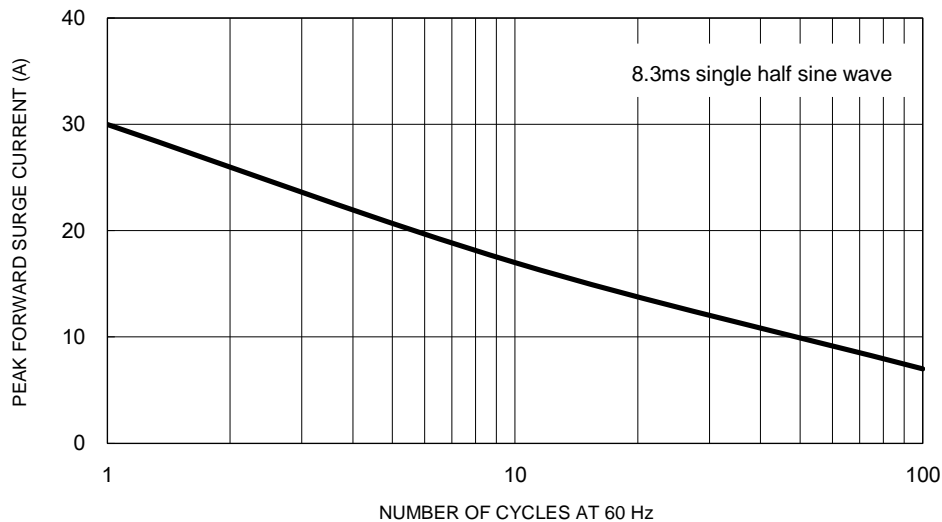

**PACKAGE OUTLINE DIMENSIONS**

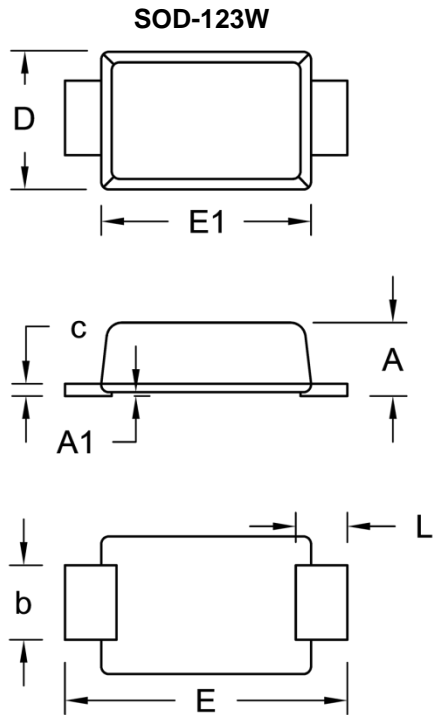

DIM.	Unit (mm)		Unit (inch)	
	Min.	Max.	Min.	Max.
A	0.90	1.02	0.035	0.040
A1	0.00	0.10	0.000	0.004
b	0.90	1.05	0.035	0.041
c	0.10	0.22	0.004	0.009
D	1.70	1.90	0.067	0.075
E	3.60	3.80	0.142	0.150
E1	2.60	2.90	0.102	0.114
L	0.50	0.85	0.020	0.033

**SUGGESTED PAD LAYOUT**

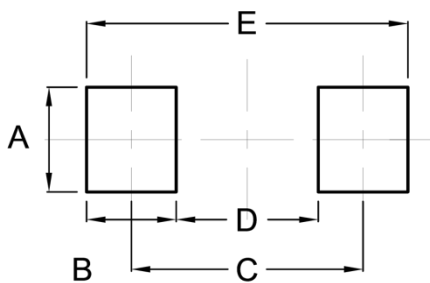

Symbol	Unit (mm)	Unit (inch)
A	1.40	0.055
B	1.20	0.047
C	3.10	0.122
D	1.90	0.075
E	4.30	0.169

**MARKING DIAGRAM**



P/N = Marking Code  
 YW = Date Code  
 F = Factory Code

## Notice

Specifications of the products displayed herein are subject to change without notice. TSC or anyone on its behalf assumes no responsibility or liability for any errors or inaccuracies.

Purchasers are solely responsible for the choice, selection, and use of TSC products and TSC assumes no liability for application assistance or the design of Purchasers' products.

Information contained herein is intended to provide a product description only. No license, express or implied, to any intellectual property rights is granted by this document. Except as provided in TSC's terms and conditions of sale for such products, TSC assumes no liability whatsoever, and disclaims any express or implied warranty, relating to sale and/or use of TSC products including liability or warranties relating to fitness for a particular purpose, merchantability, or infringement of any patent, copyright, or other intellectual property right.

The products shown herein are not designed for use in medical, life-saving, or life-sustaining applications. Customers using or selling these products for use in such applications do so at their own risk and agree to fully indemnify TSC for any damages resulting from such improper use or sale.