

Customer Part:

Description

- Standard 5x3.2mm SMD crystal with four pads.
Ceramic package with a seam sealed metal lid, hermetically sealed.
- Model CFPX-104
- Model Issue number 9

Frequency Parameters

- Frequency 8.0MHz
- Frequency Tolerance $\pm 20.00\text{ppm}$
- Tolerance Condition @ 25°C
- Frequency Stability $\pm 30.00\text{ppm}$
- Operating Temperature Range -40.00 to 85.00°C
- Overtone Order Fundamental
- Ageing $\pm 3\text{ppm}$ max per year @ 25°C

Electrical Parameters

- Load Capacitance (CL) 18.00pF
- Shunt Capacitance (C0) 7pF max
- Drive Level 100µW max
- ESR 150.00Ω max

Environmental Parameters

- Shock: 1500g, 0.5ms, 3 times in each of 3 mutually perpendicular planes
- Vibration: 20g (20Hz-2000Hz), 1.52mm amplitude, 20mins in 3 mutually perpendicular planes, 4 cycles
- Storage Temperature Range: -55 to 125°C

Manufacturing Details

- RoHS Terminations Au 0.3um~1.0um
- RoHS Reflow Temp 260degC max for 30s max

Compliance

- RoHS Status (2015/863/EU) Compliant
- REACH Status Compliant
- MSL Rating (JDEC-STD-033): Not Applicable

Packaging Details

- Pack Style: Bulk Loose in bulk pack
Pack Size: 100
- *Alternative packing option available*

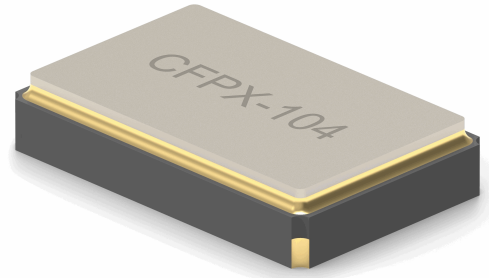

Outline (mm)



Recommended Solder Pad Layout

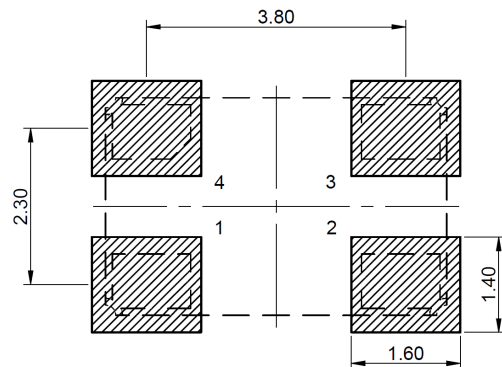

Sales Office Contact Details:

UK: +44 (0)1460 270200
Germany: 0800 1808 443

France: 0800 901 383
USA: +1.760.318.2824

Email: info@iqdfrequencyproducts.com
Web: www.iqdfrequencyproducts.com