

THIS IS A C.A.D. GENERATED DRAWING
DO NOT MAKE MANUAL REVISIONS TO MASTER.

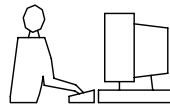

* UNLESS OTHERWISE SPECIFIED TOLERANCES
ON DECIMAL IS: .0* = ± .2*
.00* = ± .1*

UNIT: MM X.X = ±0.25
X.XX = ±0.15
X.XXX = ±0.10

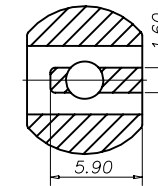
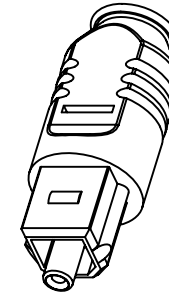
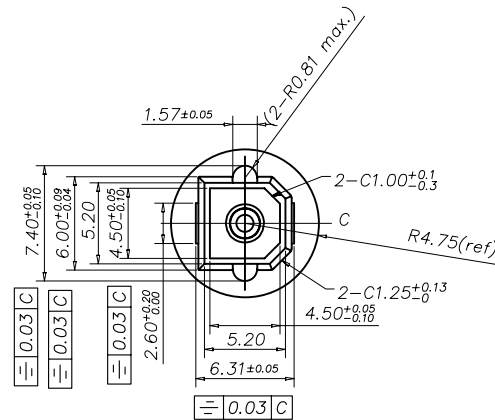
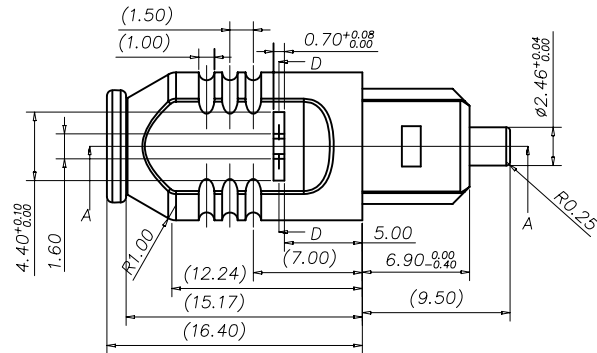
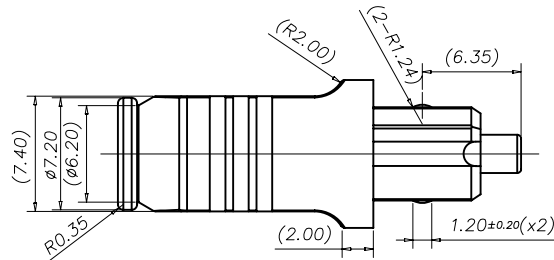

SECTION D-D

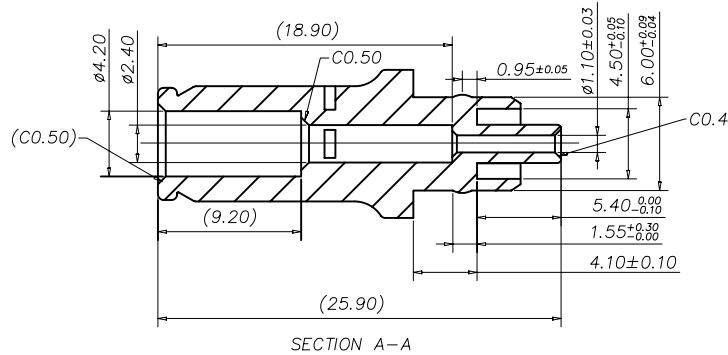

SECTION A-A

NOTES:

- MATERIAL : PBT G.F.15%(UL94-V0), PANTONE BLACK.

THESE DRAWINGS AND SPECIFICATIONS ARE THE PROPERTY OF MH CONNECTORS LTD. AND SHALL NOT BE REPRODUCED, COPIED OR USED AS THE BASIS FOR THE MANUFACTURE OR SALE OF APPARATUS WITHOUT WRITTEN PERMISSION.			DRAWN JOHNNY		DATE 06-19-13	
			APPROVED		DATE	
SCALE		SHEET OF 1 OF 1		REV: 1.0		
DRAWING No MHA22T-MA22V						



THIS SERIES FULLY CONFORMS TO THE EUROPEAN UNION DIRECTIVES 2002/95/EC AND 2002/96/EC FOR RoHS COMPLIANCY.



MH CONNECTORS LTD.