

Miniature Rocker and Lever handle Switch

Q-9241

TYPE: **RLS-102-F1**

SPECIFICATIONS

Rating: 6A 125V AC; 3A 250V AC
 Contact R: 20mΩ max
 Insulation R: 500V DC 100MΩ min
 Dielectric Strength: 1 Minute 1500V AC
 Operating Temperature: -25°C ~ +85°C
 Electrical Life: 10, 000 Cycles

Outline Drawing

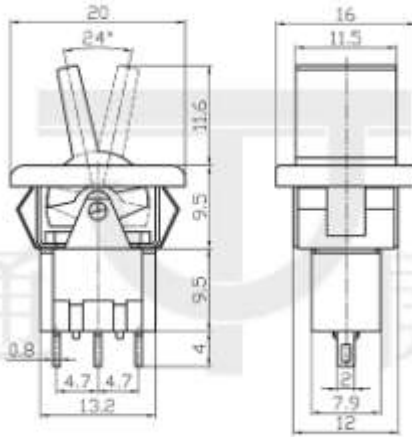

Mounting



Circuitry

