

#### Feature

- International standard package
- Low forward voltage drop
- Isolation voltage 2500V

#### Application

- DC power suppliers for apparatus device
- Input rectifying power supply for PWM converters
- Inverter welders

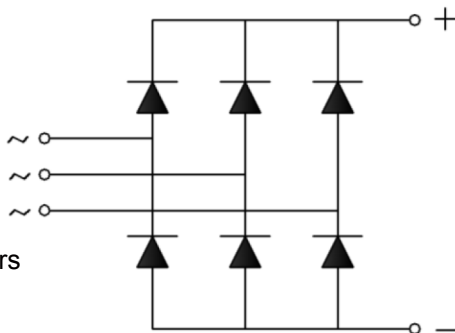

#### Maximum value

Symbol	Parameter	Rating			Unit
		SQL2502	SQL2506	SQL2510	
VRRM	Peak reverse repetitive voltage	200	600	1000	V
VRSM	Peak reverse non-repetitive voltage	300	700	1100	V

Symbol	Parameter	Test condition	Rating	Unit
IF(AV)	Mean on-state current	180° half sine wave 50Hz One side heat radiation Tc:55° C	25	A
IFSM	Forward surge current	t=10ms,50Hz,sin,Tjm	300	A
I <sup>2</sup> t	I <sup>2</sup> t value	VR = 0.6VRRM, Tjm	374	A <sup>2</sup> S
VISO	Isolation voltage	50Hz, R.M.S, t=1min, liso:1mA(max)	2000	V
Tj	Operating junction temperature		-40 to +150	°C
Tjm	Rated junction temperature		150	°C
Tstg	Storage temperature		-40 to +150	°C
Md	Mounting torque (copper plate) M5		2	N•M
Wt	weight		55	g

#### Electrical characteristics

Symbol	Parameter	Test condition	Rating	Unit
IRRM	Peak reverse repetitive current	VR=VRRM, sine half Tj=25°C	5	μA
		VR=VRRM, sine half Tj=150°C	3	mA
VFM	Peak forward voltage	IFM =12.5A, Tj=25°C	1.1	V
Rth(j-c)	Thermal impedance (junction-case)	Single-side heat dissipation, sine half wave	1.9	°C/W

### Performance Curves

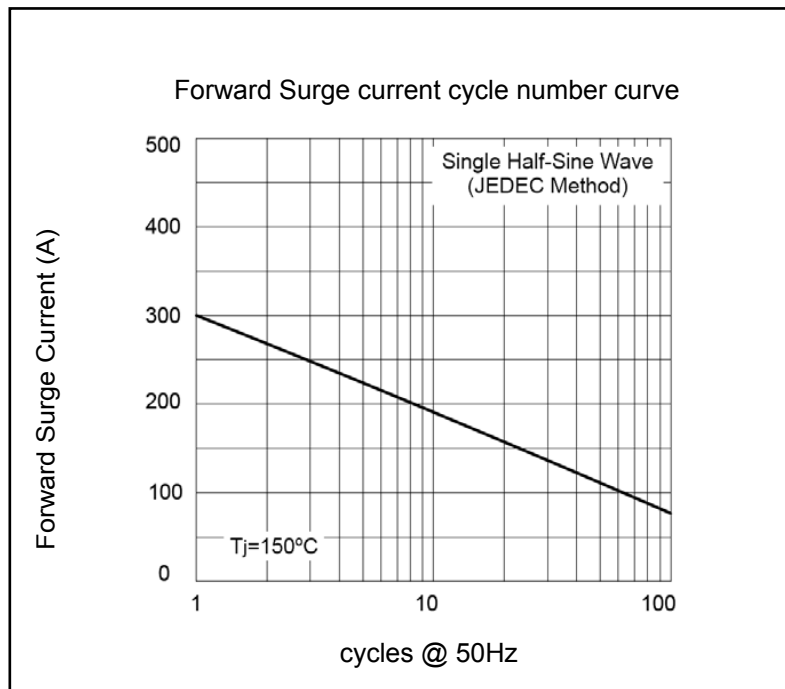
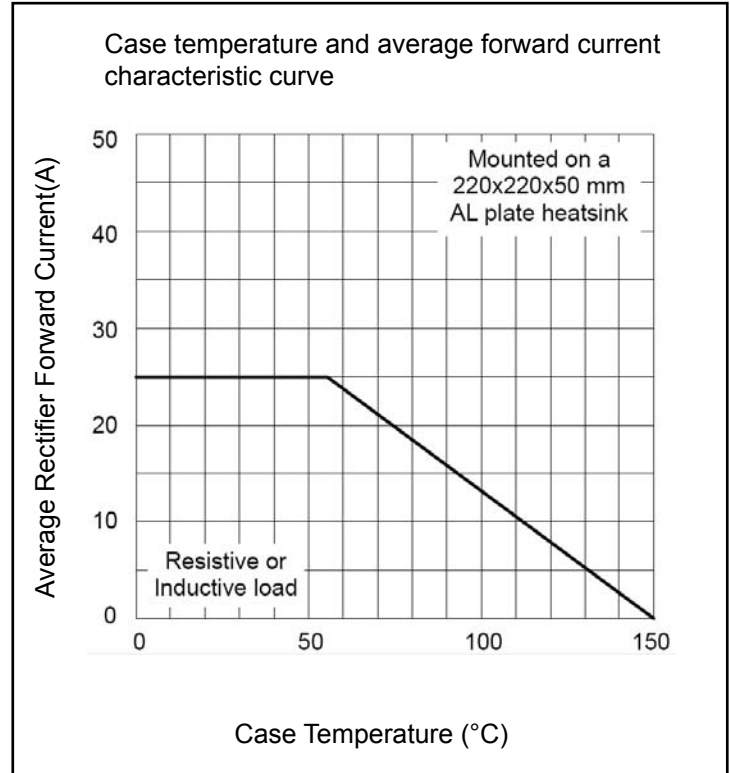
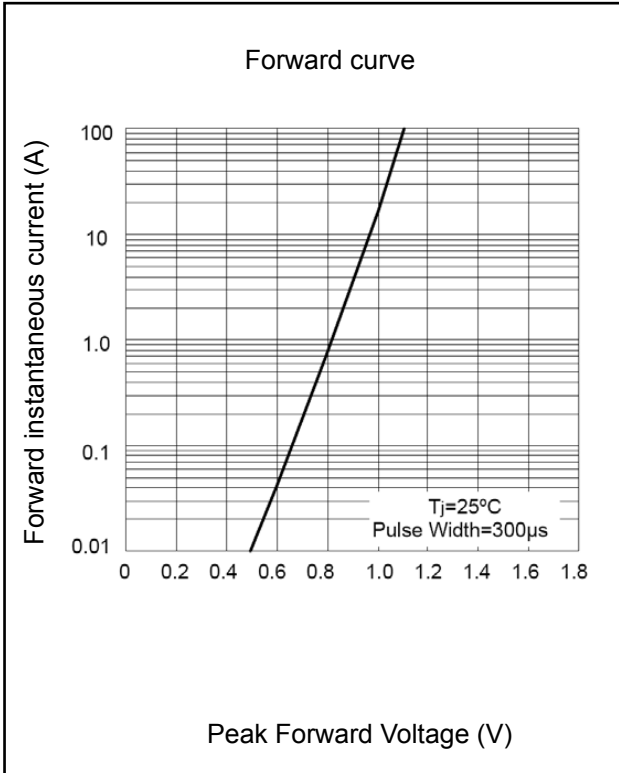

Dimension

