

DSO Shell DIY Kit

User Manual Rev. 08

See page 2 for tools needed

Applicable models: 15001K, 15002K

Applicable firmware version: 113-15001-110 or later

Before you start

- ① Check kit contents and part quantities/values by the photo at right and part list in page 2 and page 3. Report missing or wrong parts to your vendor.
- ② Resistor values are easy to mis-read. It is strongly suggested to check their values by ohm-meter before soldering them to board.
- ③ Make sure you understand the polarities and orientations of all parts.

Important !!!

If you have purchased 15002K kit (SMD not pre-soldered) you must install all SMD parts before mounting the through-hole parts. Please refer to the instructions below for SMD part installation. Otherwise, proceed to page 2 to start through-hole part assembly.

SMD parts are only installed to the analog board (PCB PN# 109-15001-xxx).



How to Solder SMD Parts

1. Before soldering check components against the part list to make sure you have correct parts.
2. Identify IC orientation and diode polarity (see photos).
3. Do not put iron on one pad for too long time. Otherwise, traces may peel off and get damaged.

SMD Part Lis (For PCB 109-15001-00F)

Loc/Ref	Qty	Descriptions
U1	1	TL084, SO14
U2	1	74HC4053, SO16
U3	1	74HC4051, SO16
U4	1	78L05, SOT89
U5	1	ICL7660, SO8
U6	1	79L05, SOT89
R19, R20	2	1K, 1%, 0805
R17, R18	2	10K, 1%, 0805
C3, C5	2	Cap trimmer, 30pF
C9, C12, C13, C14, C15, C16, C17, C18	8	0.1uF, 50V, 0805

Identify IC orientation



PIN 1

Place IC in front of you so that its marking read from left to right. The first pin at lower-left corner is pin 1.

Solder ICs

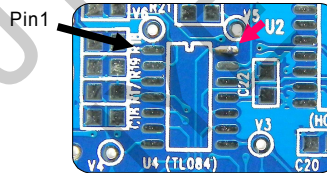

Apply solder to a corner pad

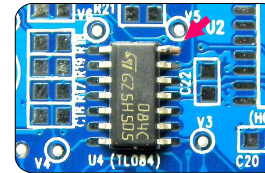

Solder IC to the pad. Make sure pins are aligned to pads

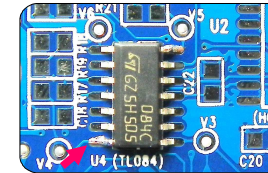

Solder the pin at the opposite corner so as chip is fixed

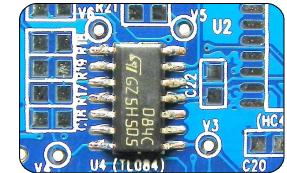

Solder all the rest pins one by one

Solder two-terminal parts

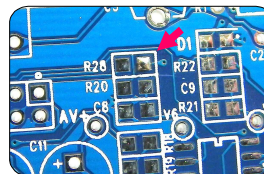

Apply solder to one pad

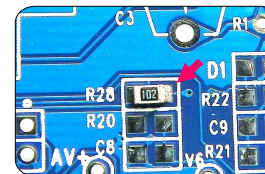

Solder part to the pad

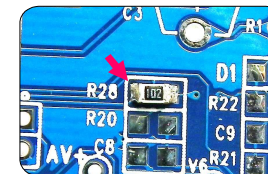

Solder the other pad

Note:

Photos here are for illustration only. They may not match the real board.

Important

If your kit does not have SMD device pre-soldered you are strongly suggested to install all SMD parts before mounting through-hole parts. Please see instructions at Page 1.

Tools you need

- ① 20 - 25W iron for most of parts. For the BNC connector higher power iron (50 - 100W) is recommended if available.
- ② Rosin solder wire (0.8 - 1mm dia.)
- ③ Digital multimeter
- ④ Screw driver (phillips, size# 0)
- ⑤ Flush cutter
- ⑥ Tweezers
- ⑦ DC 9V power supply with 200mA (or higher) current capacity and 5.5 x 2.1mm plug.
- ⑧ Needle-nose pliers
- ⑨ Small slotted screwdriver (2mm width, for cap trimmer adjustment)

Soldering Hints

- ① Put leads through mounting holes from the side with part outline. Ensure component evenly touch PCB.
- ② Solder leads at the other side. Solder should fully fill and cover soldering pads. Avoid bridges between neighboring pads.
- ③ Cut unused leads flush with cutter.

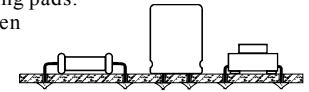

Step 1 Assembly the Main Board (follow the order as numbered)

1. Check the main board

- ① Before mounting any parts to the main board connect a 9V power supply (center positive) to J7 on the board to check the display.
- ② You should see the scope boots up to a screen similar to the photo below. D1 (LED) blinks twice.

Do not solder any parts to the board if you find problem. Otherwise warranty will be voided. Report the problem to vendor or JYE Tech.

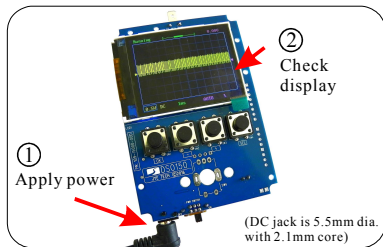

(DC jack is 5.5mm dia. with 2.1mm core)

2. Test Signal Terminal

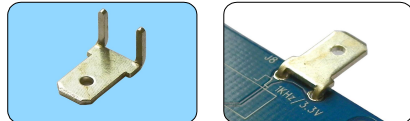

J8 : 4.8 x 0.8mm terminal

Note: Before soldering bend the terminal to the shape as shown in the left photo above.

3. Power Connector (optional)

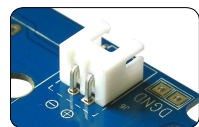

J6: 0.1" pitch, rightangle

4. Slide Switch

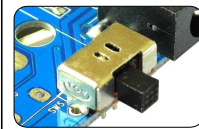

SW5 : DPDT

5. Pin-header (male)

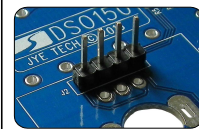

J2 : 1X4 pin, 0.1" pitch

6. Tact Switches

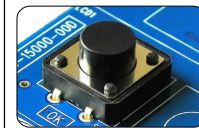

SW1, SW2, SW3, SW4 : 12x12x7mm

7. Remove Resistor R30

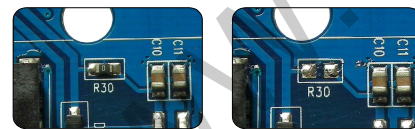

Let iron stay on one pad of the resistor until solder on the other pad melt and then remove the part.

Note:

R30 is used to bypass SW5 so as the mainboard can be tested without the power switch. It must be removed for correct functioning of the power switch.

Now apply power again. Test power switch and tact buttons for their correct functions.

Step 2 Assembly the Analog Board (follow the order as numbered)

1. Resistors



Note:
Always meter resistor values before soldering.
Resistors are all 1/8W.

<input type="checkbox"/> R1 : 510K Ω	<input type="checkbox"/> R7 : 300 Ω
<input type="checkbox"/> R2 : 5.1M Ω	<input type="checkbox"/> R8, R16 : 150 Ω
<input type="checkbox"/> R3 : 1.2M Ω	<input type="checkbox"/> R9 : 91 Ω
<input type="checkbox"/> R4 : 11K Ω	<input type="checkbox"/> R10 : 30 Ω
<input type="checkbox"/> R5, R6, R14 : 1K Ω	<input type="checkbox"/> R11, R12 : 15 Ω
	<input type="checkbox"/> R13 : 3K Ω
	<input type="checkbox"/> R15 : 130 Ω

2. Ceramic Capacitors

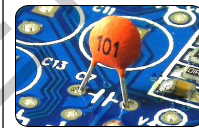

<input type="checkbox"/> C1 : 0.1 μ F
<input type="checkbox"/> C2 : 330pF
<input type="checkbox"/> C4 : 1pF
<input type="checkbox"/> C6 : 150pF

3. Slide switch

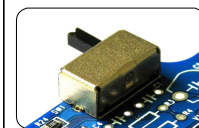

SW1 : 2P3T

4. Electrolytic capacitors

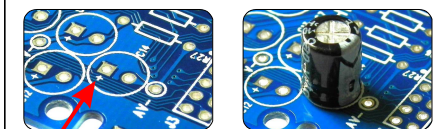

Solder positive pole (the longer lead) to the square pad

C8, C10, C11 : 100 μ F / 16V

5. BNC connector

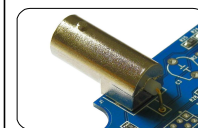

J1 : BNC

Note:

The thicker pins need to heat up longer to get good soldering result.

6. Pin-header (male)

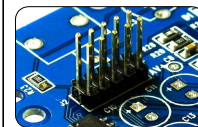

J2 : 2 X 5 pin, 2mm pitch

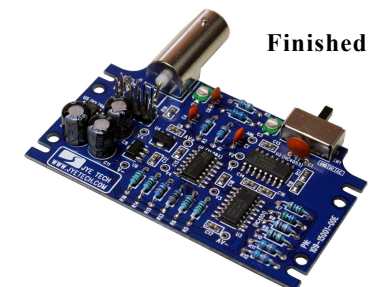

If you have questions post them to www.jyetechnology.com/forum.

Step 3 Assembly Front Module

1. Solder Rotary Encoder



Mount to the small PCB (PN: 109-15002-00A)

Note: Please pay attention to the orientation of PCB. Use the side with outline marking.

2. Assemble Front Module

- Fit LCD to front panel as shown below.

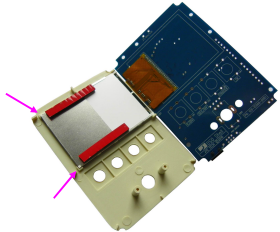

- Fold the main board over while keeping LCD in place.

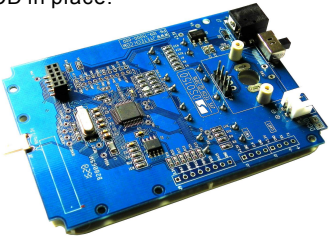

- Mount rotary encoder board to the front plate with screws and solder the board to J2 of the main board.

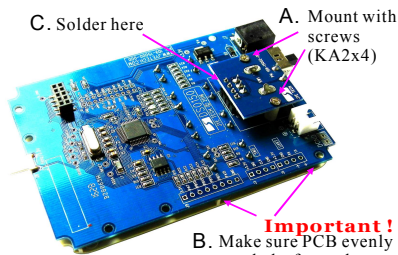

Important!
B. Make sure PCB evenly touch the front plate while doing C.

Step 4 Check Voltages

Verify voltages on the analog board

- Attach the analog board to the main board by mating J2 on the analog board to J4 on the main board (see photo).
- Apply 9V DC power supply to J7 (or J6) on the main board.
- Set couple switch to GND position.
- Check voltages at the points as shown in the photo.

Measurements applicable for PCB version 109-15001-00E or later

References

(*) Input dependent

Input	+9.30V
V+ (*)	+8.35V
AV+	5.0V+/-2%
V- (*)	-7.86V
AV-	-5.0V+/-2%
V1	0V
V2	0V
V3	0V
V4	~1.65V

Place negative pen at DGND

Apply power here
(DC jack is 5.5mm dia. with 2.1mm core)

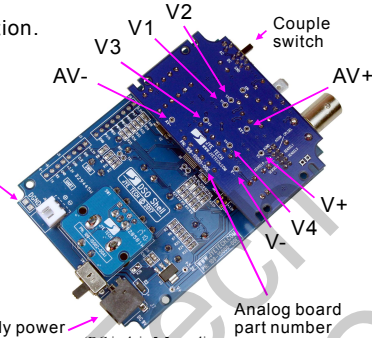

Analog board part number

Important!
Always remove power before connecting or disconnecting the analog board.

Step 5 Calibration

Tips:
Perform VPos alignment before calibrating C3 and C5.

Adjust trimmers C3 and C5

- Connect the red clip to the test signal terminal and leave the black clip un-connected (see photo at bottom).
- Apply power and boot. Hold down ADJ dial for 3 seconds to bring up Test Signal amplitude display at lower-left corner. Push ADJ to set the amplitude to 0.1V.
- Set sensitivity to 50mV and adjust trigger level so that waveform stable (see "How to Use" at page 4).
- Tuning C3 so that sharp rectangle (photo B at left) is obtained. The adjustment for C3 is done.
- Similarly, for C5 calibration push ADJ to set test signal to 3.3V. Change sensitivity to 1V. Tuning C5 so that sharp rectangle waveform is obtained. The adjustment is done.

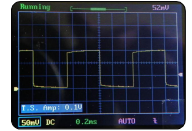

A. Not enough

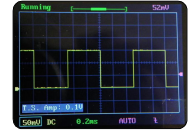

B. Good

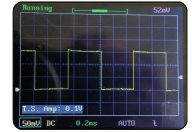

C. Too much

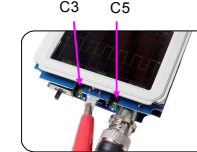

Step 6 Put all parts together

It is strongly recommended to read the article "FAQ, Tips, and Troubleshooting" at www.jytech.com/forum under the sub-forum "DSO Shell".

Final assembly

- Screw the analog board to back cover with the top bracket attached

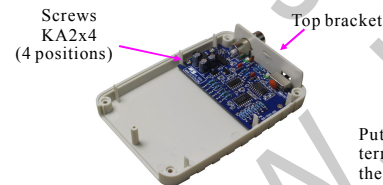

- Combine the front module and the back cover



- Make sure receptacle (J4) mate with pin-header (J2)

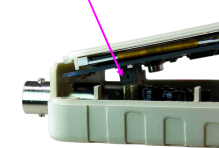

- Attach bottom bracket before holding the two modules together



- Attach the front frame



- Firmly press the frame in



- Screw up at the back

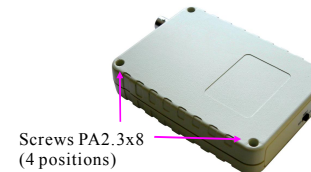

- Attach knob cap and done!



How to Use

Display and Controls

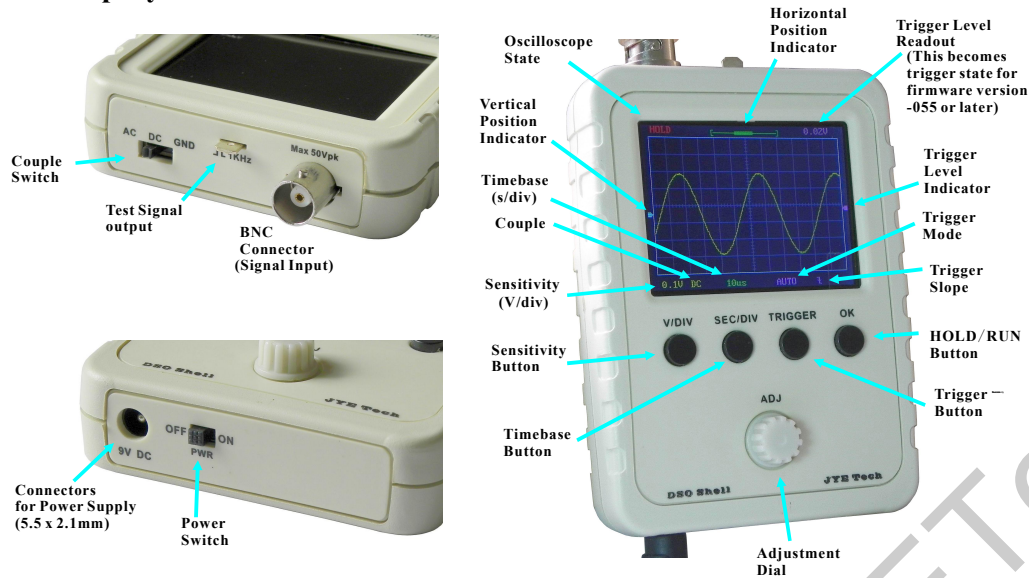

Connections

Power Supply: Connect 9V DC power supply to the 5.5x2.1mm jack at bottom (center positive). Power supply voltage must be in the range of 8 - 10V.

Probe: Connect probe to the BNC connector at top.

Operations

Basic Button Functions

[V/DIV]: Select sensitivity or vertical position. The selected parameter indicator will be highlighted.

[SEC/DIV]: Select timebase or horizontal position. The selected parameter indicator will be highlighted.

[TRIGGER]: Select trigger mode, trigger level, or trigger edge. The selected parameter indicator will be highlighted.

[OK]: Enter HOLD state (freeze waveform). Press it again will de-freeze.

[ADJ]: Adjust the parameter selected (highlighted). Short press toggles *Fast Adjustment* mode.

Couple switch: Set couple to DC, AC, or GND. When GND is selected the scope input is isolated from input signal and connected to ground (0V input).

Attention

1. Power supply voltage must not exceed 10V. Otherwise it may damage the ICs inside.
2. Allowed maximum signal input voltage is 50Vpk (100Vpp) with the clip probe.

Specifications

Max realtime sample rate	1MSa/s	Timebase range	500s/Div -- 10us/Div
Analog bandwidth	0 -- 200KHz	Trigger modes	Auto, Normal, and Single
Sensitivity range	5mV/div - 20V/div	Trigger position	Center of buffer
Max input voltage	50Vpk (1X probe)	Power supply	9V DC (8 - 10V)
Input impedance	1M ohm/20pF	Current consumption	~120mA @ 9V
Resolution	12 bits	Dimension	105 x 75 x 22mm
Record length	1024 points	Weight	100 gram (without probe and PS)

More Functions

Functions	Operations
VPos Alignment	Set Couple Switch to GND position. Hold down [V/DIV] button for about 3 seconds.
Measurements ON/OFF	Hold down [OK] button for about 3 seconds. This will turn ON or OFF on-screen display of measurements including Vmax, Vmin, Vavr, Vpp, Vrms, Freq., Cycle, Pulse width, and Duty cycle.
Save Waveform	Press [ADJ] & [SEC/DIV] buttons simultaneously. The currently displayed waveform will be saved to EEPROM. The existing data in EEPROM will be over-written.
Recall Waveform	Press [ADJ] & [Trigger] buttons simultaneously. Recalled waveform is always displayed in Hold state.
Default Restore	Hold down [SEC/DIV] and [TRIGGER] buttons simultaneously for about 3 seconds.
Center HPos	Hold down [SEC/DIV] button for about 3 seconds. This will make the data at the center of capture buffer displayed.
Center Trigger Level	Hold down [TRIGGER] button for about 3 seconds. This will set the trigger level to the medium value of signal amplitude.
Fast Adjustment	Short press of [ADJ] toggles <i>Fast Adjustment</i> mode on and off for VPos, HPos, and Trigger Level. A ">>" sign appearing at top of screen indicates <i>Fast Adjustment</i> is ON.
Send Waveform Data	Press [ADJ] & [V/DIV] buttons simultaneously will send waveform data in texts via serial port J5. The baudrate is 115200. Data format is 8N1.

About Trigger State

The trigger can have three states including Holdoff, Waiting, and Triggered. They are explained below.

Holdoff: Trigger is disabled until a portion of sample buffer prior to a trigger point is filled with raw data.

Waiting: Trigger is waiting for a valid signal slope.

Triggered: A valid signal slope has been detected and registered.

Rolling Mode

When timebase is set to 50ms or slower and trigger mode is set to AUTO the scope will automatically switch to *Rolling Mode* where waveform shifts from right to left constantly. The trigger is disabled under this mode.

Troubleshooting

Problems	Possible Causes
Bad V+	① Connector J7 defective. ② Diode D2 open or damaged.
Bad V-	① Bad C10 and/or C11. ② U5 (7660) bad soldering or defective. Hint: Check with R27 disconnected would let you know the issue is caused by load or source.
Bad AV-	① U6 bad soldering or defective. ② Shorts between AV- and ground.
Bad AV+	① U4 bad soldering or defective. ② Shorts between AV+ and ground.
V1 does not close to 0V	① SW1 is not set at GND position. ② Bad soldering on R1 and/or R2. ③ Bad soldering on U1.
V2 does not close to 0V	① SW1 is not set to GND position. ② Bad soldering on R3 and/or R4. ③ Bad soldering on U1.
V3 does not close to 0V	① Bad soldering on U1 and/or U2. ② Bad soldering on R5 and/or R6.
Bad V4	① Bad soldering on R13, R14, and R15.
No Trace	① Incorrect V4. If V4 is correct perform factory default restore as described in ② below. ② Hold down [SEC/DIV] and [TRIGGER] buttons simultaneously for 3 seconds.

Mouser Electronics

Authorized Distributor

Click to View Pricing, Inventory, Delivery & Lifecycle Information:

[Seeed Studio:](#)

[109990266](#)