

FEATURES

- Thermoplastic handles
- Zinc plated steel or stainless steel studs
- Matte black finish
- Can short term withstand +170°C
- Resistant to most chemicals, UV light and water absorption (1.5% max)
- Working temperature range of -30°C to +110°C

RS PRO Black Multiple Lobes Clamping Knob, M8

RS Stock No.: 702-7633



RS Professionally Approved Products bring to you professional quality parts across all product categories. Our product range has been tested by engineers and provides a comparable quality to the leading brands without paying a premium price.

Product Description

Knobs are used in a wide variety of applications in our day-to-day lives and perform many functions, from being used as fixed handles to being used to tighten, loosen, adjust and push other components or pieces of equipment. They are used in various applications, from industrial and construction machinery to audio and visual equipment.

Female Knobs: Zinc-plated steel: M6 x 9 (RS [7027594](#)), M8 x 12 (RS [7027598](#)), M10 x 15 (RS [7027601](#)), M10 x 15 (RS [7027605](#)), M8 x 12 (RS [7027608](#)), M12 x 8 (RS [7027614](#)). Stainless steel: M6 x 9 (RS [7027651](#)), M8 x 12 (RS [7027655](#)), M10 x 15 (RS [7027661](#)), M10 x 15 (RS [7027667](#)), M12 x 18 (RS [7027670](#)).

Male Knobs: Zinc-plated steel: M6 x 20mm (RS [7027579](#)), M6 x 25mm (RS [7027572](#)), M8 x 20mm (RS [7027576](#)), M8 x 30mm (RS [7027585](#)), M8 x 25mm (RS [7027588](#)), M10 x 25mm (RS [7027582](#)), M12 x 30mm (RS [7027591](#)). Stainless steel: M6 x 15mm (RS [7027627](#)), M6 x 20mm (RS [7027636](#)), M6 x 25mm (RS [7027639](#)), M8 x 20mm (RS [7027633](#)), M8 x 30mm (RS [7027642](#)), M8 x 25mm (RS [7027645](#)), M10 x 25mm (RS [7027649](#)), M12 x 30mm (RS [7027658](#)).

Through-Thread Knobs: Zinc-plated steel: M8 x 12 (RS [7027611](#)), M6 x 9 (RS [7027617](#)), M10 x 15 (RS [7027620](#)), M12 x 18 (RS [7027623](#)). Stainless steel: M8 x 12 (RS [7027664](#)), M6 x 9 (RS [7027673](#)), M8 x 15 (RS [7027677](#)), M12 x 18 (RS [7027683](#)), M8 x 12 (RS [7027686](#)), M10 x 15 (RS [7027689](#)).

General Specifications

Thread	M8
Knob Shape	Multiple Lobes
Mounting Type	Threaded Stud
Body Material	High impact resistant thermoplastic
Insert Material	Stainless Steel
Colour	Black
Finish	Matt
Application	Access doors, Drawers & panels (domestic and industrial), Clamps and fixtures, Industrial machinery, Food preparation machinery, Medical furniture

Mechanical Specifications

Thread Diameter	8mm
Thread Length	20mm
Knob Diameter	40mm
Hole Diameter	18mm
Hole Length	29mm

Approvals

Compliance/Certifications	EN 61340
---------------------------	----------

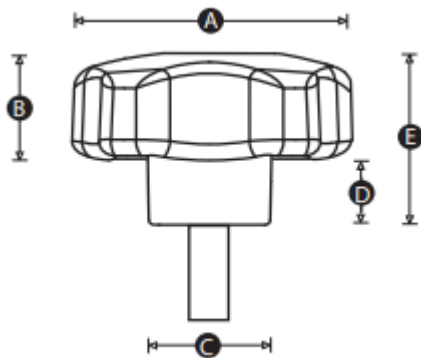

Part No.	A	B	C	D	E	Thread size	Thread length (mm)	Material	Thread material
7027627	28	16	14	9	25	M6	15	Polypropylene	Stainless steel
7027579	28	16	14	9	25	M6	20	Polypropylene	Zinc plated steel
7027636	28	16	14	9	25	M6	20	Polypropylene	Stainless steel
7027572	40	17	18	12	29	M6	25	Polypropylene	Zinc plated steel
7027639	40	17	18	12	29	M6	25	Polypropylene	Stainless steel
7027576	40	17	18	12	29	M8	20	Polypropylene	Zinc plated steel
7027633	40	17	18	12	29	M8	20	Polypropylene	Stainless steel
7027585	40	17	18	12	29	M8	30	Polypropylene	Zinc plated steel
7027642	40	17	18	12	29	M8	30	Polypropylene	Stainless steel
7027588	50	19	21	12	31	M8	25	Polypropylene	Zinc plated steel
7027645	50	19	21	12	31	M8	25	Polypropylene	Stainless steel
7027582	60	21	21	13	34	M10	25	Polypropylene	Zinc plated steel
7027649	60	21	21	13	34	M10	25	Polypropylene	Stainless steel
7027591	60	21	21	13	34	M12	30	Polypropylene	Zinc plated steel
7027658	60	21	21	13	34	M12	30	Polypropylene	Stainless steel