

Photomicrosensor (Transmissive)

EE-SX4009-P10

Slot / Screw mounting / Connector Type (Slot width: 5 mm)

- Screw-mounting
- High resolution with a 0.5-mm-wide aperture
- Directly connectable to C-MOS
- Connects to US Molex connectors

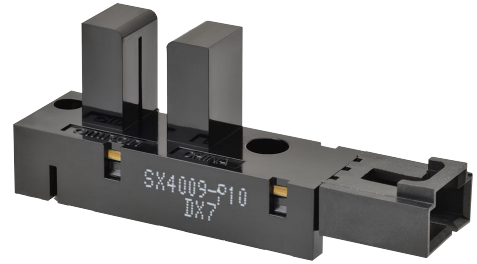

⚠ Be sure to read *Safety Precautions* on page 2.

Model Number Structure



EE-S X 4 009 - P - 10

(1) (2) (3) (4) (5) (6)

(1) Photomicrosensor	(2) Transmissive	(3) Photo IC output, Light-ON
(4) Serial number	(4) PCB mounting	(6) Serial number

Ordering Information

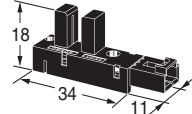
Photomicrosensor

Appearance	Sensing method	Connecting method	Sensing distance	Aperture size (H × W) (mm)	Output type	Model	Minimum packing unit (Unit: pcs)
	Transmissive (slot type)	Connector	 5 mm (slot width)	Both emitting side and detecting side 2 × 0.5	Photo IC	EE-SX4009-P10 (Light-ON)	1

Note: Order in multiples of minimum packing unit.

Ratings, Characteristics and Exterior Specifications

Absolute Maximum Ratings (Ta = 25°C)

Item	Symbol	Rated value	Unit
Power supply voltage	V _{CC}	10	V
Output voltage	V _{OUT}	28	V
Output current	I _{OUT}	16	mA
Permissible output dissipation	P _{OUT}	250 *	mW
Operating temperature	T _{opr}	-25 to +75	°C
Storage temperature	T _{stg}	-40 to +85	°C
Soldering temperature	T _{sol}	---	°C

* Refer to the temperature rating chart if the ambient temperature exceeds 25°C.

Exterior Specifications

Connecting method	Weight (g)	Material
		Case
Connector	3.4	Polycarbonate

Electrical and Optical Characteristics (Ta = 25°C, V_{CC} = 5 V ± 10%)

Item	Symbol	Value			Unit	Condition
		MIN.	TYP.	MAX.		
Current consumption	I _{CC}	---	---	30	mA	With and without incident
Low-level output voltage	V _{OL}	---	---	0.3	V	I _{OUT} = 16 mA, with incident
High-level output voltage	V _{OH}	(V _{CC} × 0.9)	---	---	V	V _{OUT} = V _{CC} , without incident, R _L = 47 kΩ
Response frequency	f	3	---	---	kHz	V _{OUT} = V _{CC} *, R _L = 47 kΩ

* The value of the response frequency is measured by rotating the disk as shown below.

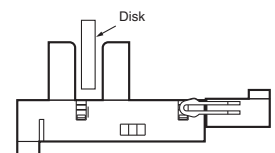
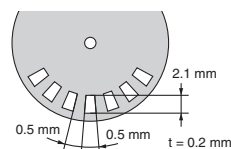

Engineering Data (Reference value)

Fig 1. Output Allowable Dissipation vs. Ambient Temperature Characteristics

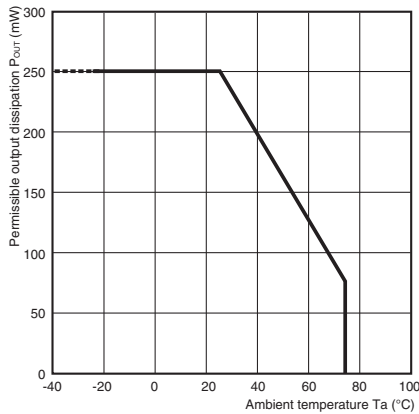
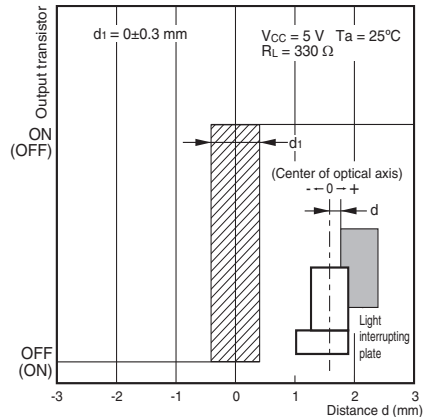

Fig 2. Sensing Position Characteristics (Typical)



Safety Precautions

To ensure safe operation, be sure to read and follow the Instruction Manual provided with the Sensor.

⚠ CAUTION

This product is not designed or rated for ensuring safety of persons either directly or indirectly. Do not use it for such purposes.



Precautions for Correct Use

Do not use the product in atmospheres or environments that exceed product ratings. Dispose of this product as industrial waste.

Precautions for Safe Use

Do not use the product with a voltage or current that exceeds the rated range.

Applying a voltage or current that is higher than the rated range may result in explosion or fire.

Do not miswire such as the polarity of the power supply voltage.

Otherwise the product may be damaged or it may burn.

Do not short-circuit the load.

Otherwise explosion or burning may occur.

This product does not resist water.

Dimensions and Internal Circuit

Photomicrosensor

EE-SX4009-P10



Aperture size (H x W) (mm)

Emitter	Detector
2 x 0.5	2 x 0.5

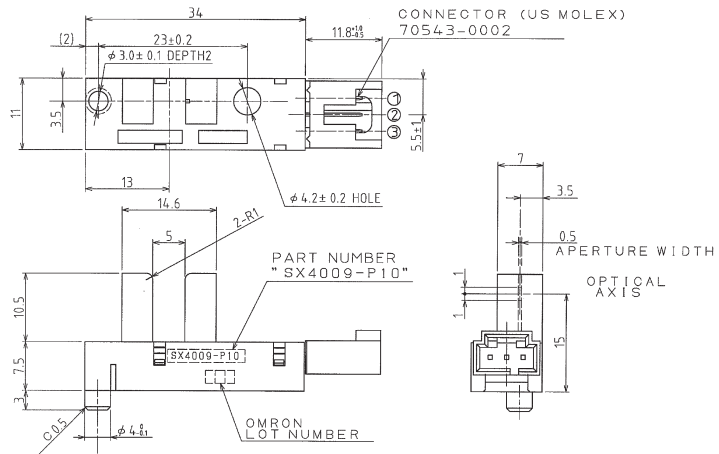

Internal circuit

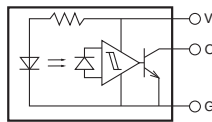

Unless otherwise specified, the tolerances are as shown below.

Terminal No.	Name
V	Power supply (V _{CC})
O	Output voltage (OUT)
G	Ground (GND)

Dimensions	Tolerance
4 mm max.	±0.2
4 < mm ≤ 16	±0.3
16 < mm ≤ 63	±0.5

Please check each region's Terms & Conditions by region website.

OMRON Corporation

Device & Module Solutions Company

Regional Contact

Americas

<https://components.omron.com/us>

Asia-Pacific

<https://components.omron.com/ap>

Korea

<https://components.omron.com/kr>

Europe

<https://components.omron.com/eu>

China

<https://components.omron.com.cn>

Japan

<https://components.omron.com/jp>