

Reference Specification

Metal Terminal Type Multilayer Ceramic Capacitors for General Purpose  
KRM55 Series [Temp. Char.:U2J, Rat. Vol.:DC630V ~ DC1250V]

Product specifications in this catalog are as of May.2020, and are subject to change or obsolescence without notice.  
Please consult the approval sheet before ordering.Please read rating and Cautions first.

**⚠ Caution****■ Storage and Operation Conditions**

1. The performance of chip monolithic ceramic capacitors may be affected by the storage conditions.
  - 1-1. Store the capacitors in the following conditions: Room Temperature of +5°C to +40°C and a Relative Humidity of 20% to 70%.
    - (1) Sunlight, dust, rapid temperature changes, corrosive gas atmosphere, or high temperature and humidity conditions during storage may affect solderability and packaging performance. Therefore, please maintain the storage temperature and humidity. Use the product within six months after delivery, as prolonged storage oxidation of the electrodes.
    - (2) Please confirm solderability before using after six months. Store the capacitors without opening the original bag. Even if the storage period is short, do not exceed the specified atmospheric conditions.
  - 1-2. Corrosive gas can react with the termination(external) electrodes or lead wires of capacitors, and result in poor solderability. Do not store the capacitors in an atmosphere consisting of corrosive gas (e.g., hydrogen sulfide, sulfur dioxide, chlorine, ammonia gas, etc.).
  - 1-3. Due to moisture condensation caused by rapid humidity changes, or the photochemical change caused by direct sunlight on the terminal electrodes and/or the resin/epoxy coatings, the solderability and electrical performance may deteriorate. Do not store capacitors under direct sunlight or in high humidity conditions.

**■ Rating****1. Temperature Dependent Characteristics**

1. The electrical characteristics of a capacitor can change with temperature.
  - 1-1. For capacitors having larger temperature dependency, the capacitance may change with temperature changes. The following actions are recommended in order to ensure suitable capacitance values.
    - (1) Select a suitable capacitance for the operating temperature range.
    - (2) The capacitance may change within the rated temperature. When you use a high dielectric constant type capacitor in a circuit that needs a tight (narrow) capacitance tolerance (e.g., a time-constant circuit), please carefully consider the temperature characteristics, and carefully confirm the various characteristics in actual use conditions and the actual system.

**2. Measurement of Capacitance**

1. Measure capacitance with the voltage and frequency specified in the product specifications.
  - 1-1. The output voltage of the measuring equipment may decrease occasionally when capacitance is high. Please confirm whether a prescribed measured voltage is impressed to the capacitor.
  - 1-2. The capacitance values of high dielectric constant type capacitors change depending on the AC voltage applied. Please consider the AC voltage characteristics when selecting a capacitor to be used in an AC circuit.

**3. Applied Voltage**

1. Do not apply a voltage to the capacitor that exceeds the rated voltage as called out in the specifications.
  - 1-1. Applied voltage between the terminals of a capacitor shall be less than or equal to the rated voltage.
    - (1) When AC voltage is superimposed on DC voltage, the zero-to-peak voltage shall not exceed the rated DC voltage. When AC voltage or pulse voltage is applied, the peak-to-peak voltage shall not exceed the rated DC voltage.
    - (2) Abnormal voltages (surge voltage, static electricity, pulse voltage, etc.) shall not exceed the rated DC voltage.

Typical Voltage Applied to the DC Capacitor

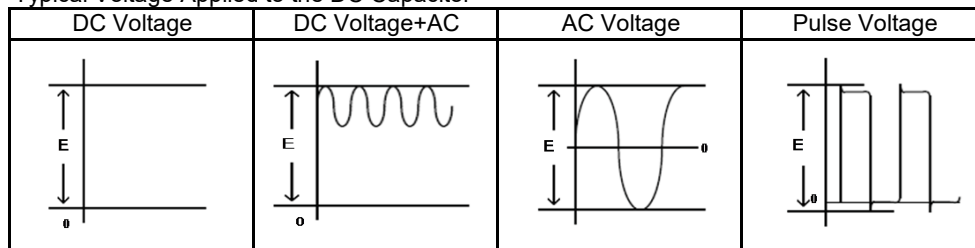

(E: Maximum possible applied voltage.)

- 1-2. Influence of over voltage
 

Over voltage that is applied to the capacitor may result in an electrical short circuit caused by the breakdown of the internal dielectric layers. The time duration until breakdown depends on the applied voltage and the ambient temperature.
2. Use a safety standard certified capacitor in a power supply input circuit (AC filter), as it is also necessary to consider the withstand voltage and impulse withstand voltage defined for each device.

**⚠ Caution****4. Type of Applied Voltage and Self-heating Temperature**

1. Confirm the operating conditions to make sure that no large current is flowing into the capacitor due to the continuous application of an AC voltage or pulse voltage. When a DC rated voltage product is used in an AC voltage circuit or a pulse voltage circuit, the AC current or pulse current will flow into the capacitor; therefore check the self-heating condition. Please confirm the surface temperature of the capacitor so that the temperature remains within the upper limits of the operating temperature, including the rise in temperature due to self-heating. When the capacitor is used with a high-frequency voltage or pulse voltage, heat may be generated by dielectric loss.

<Applicable to Temperature Characteristics U2J(7U)>

Since the self-heating is low in the low loss series, the allowable voltage becomes extremely high compared to the common X7R(R7) characteristics. However, when a load with self-heating of 20°C is applied at the rated voltage, the allowable voltage may be exceeded. Please confirm that there is no rising trend of the capacitor's surface temperature and that the surface temperature of the capacitor does not exceed the maximum operating temperature.

The excessive generation of heat may cause deterioration of the characteristics and reliability of the capacitor.

**5. DC Voltage and AC Voltage Characteristics**

1. The capacitance value of a high dielectric constant type capacitor changes depending on the DC voltage applied. Please consider the DC voltage characteristics when a capacitor is selected for use in a DC circuit.
  - 1-1. The capacitance of ceramic capacitors may change sharply depending on the applied voltage (see figure). Please confirm the following in order to secure the capacitance.
    - (1) Determine whether the capacitance change caused by the applied voltage is within the allowed range.
    - (2) In the DC voltage characteristics, the rate of capacitance change becomes larger as voltage increases, even if the applied voltage is below the rated voltage. When a high dielectric constant type capacitor is used in a circuit that requires a tight (narrow) capacitance tolerance (e.g., a time constant circuit), please carefully consider the voltage characteristics, and confirm the various characteristics in actual operating conditions in an actual system.
2. The capacitance values of high dielectric constant type capacitors changes depending on the AC voltage applied. Please consider the AC voltage characteristics when selecting a capacitor to be used in an AC circuit.

**6. Capacitance Aging**

1. The high dielectric constant type capacitors have the characteristic in which the capacitance value decreases with the passage of time. When you use high dielectric constant type capacitors in a circuit that needs a tight (narrow) capacitance tolerance (e.g., a time-constant circuit), please carefully consider the characteristics of these capacitors, such as their aging, voltage, and temperature characteristics. In addition, check capacitors using your actual appliances at the intended environment and operating conditions.

**7. Vibration and Shock**

1. Please confirm the kind of vibration and/or shock, its condition, and any generation of resonance. Please mount the capacitor so as not to generate resonance, and do not allow any impact on the terminals.
2. Mechanical shock due to being dropped may cause damage or a crack in the dielectric material of the capacitor. Do not use a dropped capacitor because the quality and reliability may be deteriorated.
3. When printed circuit boards are piled up or handled, the corner of another printed circuit board should not be allowed to hit the capacitor, in order to avoid a crack or other damage to the capacitor.

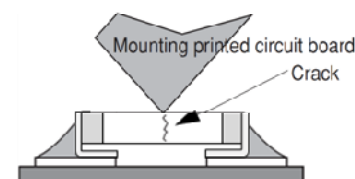
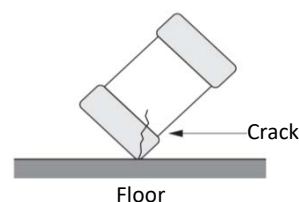

## ⚠ Caution

### ■ Soldering and Mounting

#### 1. Mounting Position

1. Confirm the best mounting position and direction that minimizes the stress imposed on the capacitor during flexing or bending of the printed circuit board.

1-1. Choose a mounting position that minimizes the stress imposed on the chip during flexing or bending of the board.

[Component Direction]

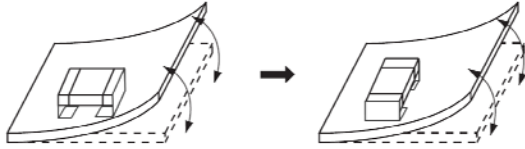

Locate chip horizontal to the direction in which stress acts.

[Chip Mounting Close to Board Separation Point]

It is effective to implement the following measures, to reduce stress in separating the board. It is best to implement all of the following three measures; however, implement as many measures as possible to reduce stress.

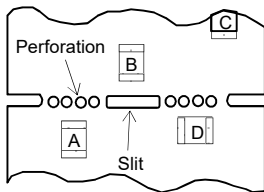

| Contents of Measures   | Stress Level |
|--|--------------|
| (1) Turn the mounting direction of the component parallel to the board separation surface. | A>D          |
| (2) Add slits in the board separation part.  | A>B          |
| (3) Keep the mounting position of the component away from the board separation surface.    | A>C          |

[Mounting Capacitors Near Screw Holes]

When a capacitor is mounted near a screw hole, it may be affected by the board deflection that occurs during the tightening of the screw. Mount the capacitor in a position as far away from the screw holes as possible.

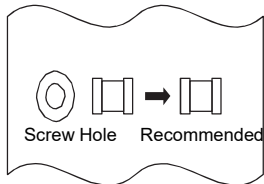

#### 2. Information before Mounting

1. Do not re-use capacitors that were removed from the equipment.
2. Confirm capacitance characteristics under actual applied voltage.
3. Confirm the mechanical stress under actual process and equipment use.
4. Confirm the rated capacitance, rated voltage and other electrical characteristics before assembly.
5. Prior to use, confirm the solderability of capacitors that were in long-term storage.
6. Prior to measuring capacitance, carry out a heat treatment for capacitors that were in long-term storage.
7. The use of Sn-Zn based solder will deteriorate the reliability of the MLCC.  
Please contact our sales representative or product engineers on the use of Sn-Zn based solder in advance.
8. We have also produced a DVD which shows a summary of our opinions, regarding the precautions for mounting.  
Please contact our sales representative to request the DVD.

#### 3. Maintenance of the Mounting (pick and place) Machine

1. Make sure that the following excessive forces are not applied to the capacitors.
  - 1-1. In mounting the capacitors on the printed circuit board, any bending force against them shall be kept to a minimum to prevent them from any bending damage or cracking. Please take into account the following precautions and recommendations for use in your process.
    - (1) Adjust the lowest position of the pickup nozzle so as not to bend the printed circuit board.
    - (2) Adjust the nozzle pressure within a static load of 1N to 3N during mounting.

[Incorrect]

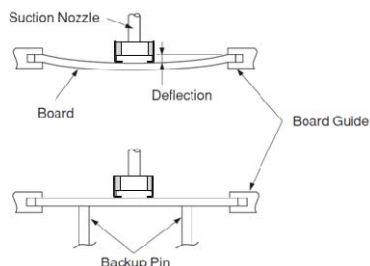

[Correct]

**⚠ Caution**

- Dirt particles and dust accumulated between the suction nozzle and the cylinder inner wall prevent the nozzle from moving smoothly. This imposes greater force upon the chip during mounting, causing cracked chips. Also, the locating claw, when worn out, imposes uneven forces on the chip when positioning, causing cracked chips. The suction nozzle and the locating claw must be maintained, checked, and replaced periodically.

**4-1. Reflow Soldering**

- When sudden heat is applied to the components, the mechanical strength of the components will decrease because a sudden temperature change causes deformation inside the components. In order to prevent mechanical damage to the components, preheating is required for both the components and the PCB. Preheating conditions are shown in table 1. It is required to keep the temperature differential between the solder and the components surface ( $\Delta T$ ) as small as possible.
- Solderability of tin plating termination chips might be deteriorated when a low temperature soldering profile where the peak solder temperature is below the melting point of tin is used. Please confirm the solderability of tin plated termination chips before use.
- When components are immersed in solvent after mounting, be sure to maintain the temperature difference ( $\Delta T$ ) between the component and the solvent within the range shown in table 1.

Table 1

| Part Number | Temperature Differential          |
|-------------|-----------------------------------|
| K□□55       | $\Delta T \leq 130^\circ\text{C}$ |

**Recommended Conditions**

|                  | Pb-Sn Solder |                                     | Lead Free Solder |
|------------------|--------------|-------------------------------------|------------------|
|                  | Reflow       | Vapor Reflow                        |                  |
| Peak Temperature | 230 to 250°C | 230 to 240°C                        | 240 to 260°C     |
| Atmosphere       | Air          | Saturated vapor of inactive solvent | Air or N2        |

Pb-Sn Solder: Sn-37Pb

Lead Free Solder: Sn-3.0Ag-0.5Cu

**4. Optimum Solder Amount for Reflow Soldering**

- 4-1. If solder paste is excessive, solder between a chip and a metal terminal melts. This causes the chip to move and come off.
- 4-2. If solder paste is too little, it causes a lack of adhesive strength on the metal terminal and the capacitor comes off.
- 4-3. Please make sure that solder is smoothly applied higher than 0.3mm and lower than the level of the bottom of the chip.

**Inverting the PCB**

Make sure not to impose any abnormal mechanical shocks to the PCB.

**4-2. Flow Soldering**

- Do not apply flow soldering.

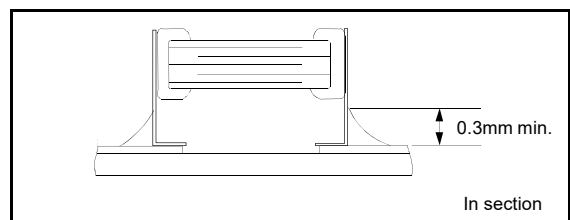
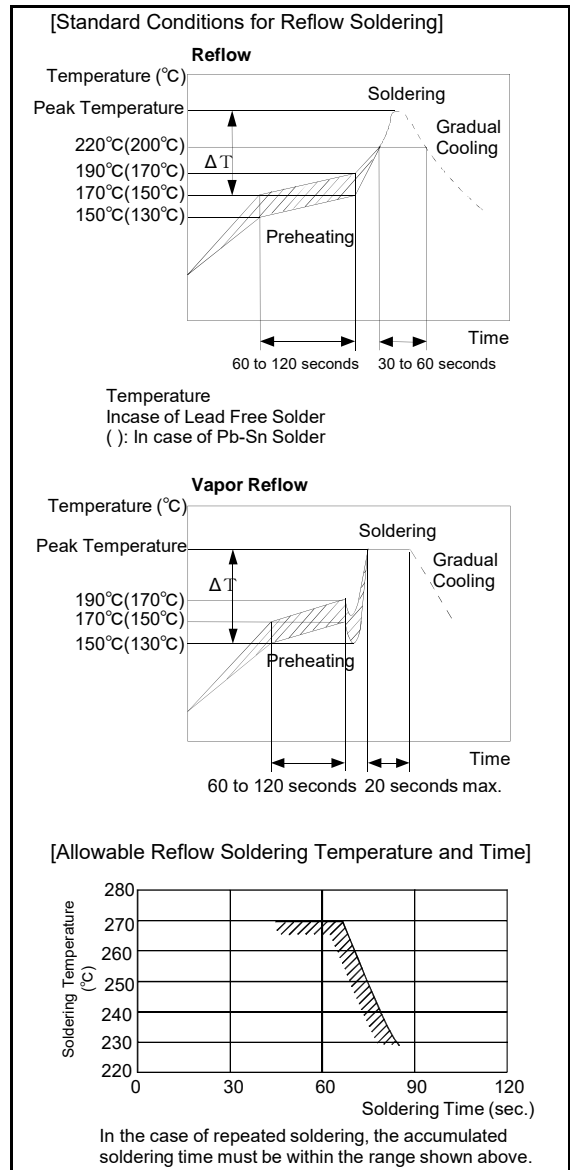

## ⚠ Caution

### 4-3. Correction of Soldered Portion

- For the shape of the soldering iron tip, refer to the figure on the right.
- Regarding the type of solder, use a wire diameter of  $\phi 0.5\text{mm}$  or less (rosin core wire solder).
- Apply the tip of the soldering iron against the lower end of the metal terminal.
  - In order to prevent cracking caused by sudden heating of the ceramic device, do not touch the ceramic base directly.
  - In order to prevent deviations and dislocating of the chip, do not touch the junction of the chip and the metal terminal, and the metal portion on the outside directly.
- The amount of solder for corrections by soldering iron, should be lower than the height of the lower side of the chip.

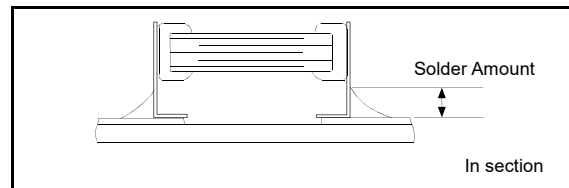
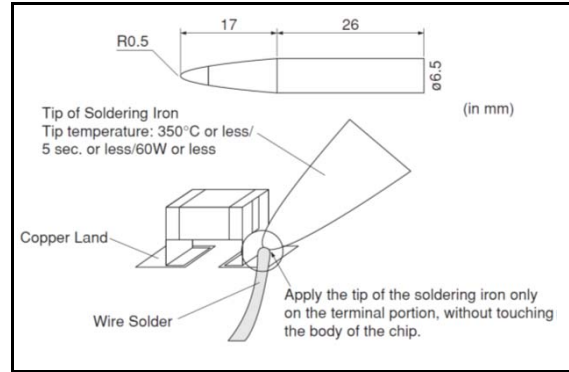

### 5. Washing

Excessive ultrasonic oscillation during cleaning can cause the PCBs to resonate, resulting in cracked chips or broken solder joints. Take note not to vibrate PCBs.

### 6. Electrical Test on Printed Circuit Board

- Confirm position of the backup pin or specific jig, when inspecting the electrical performance of a capacitor after mounting on the printed circuit board.
  - Avoid bending the printed circuit board by the pressure of a test-probe, etc. The thrusting force of the test probe can flex the PCB, resulting in cracked chips or open solder joints. Provide backup pins on the back side of the PCB to prevent warping or flexing. Install backup pins as close to the capacitor as possible.
  - Avoid vibration of the board by shock when a test-probe contacts a printed circuit board.

[Not Recommended]

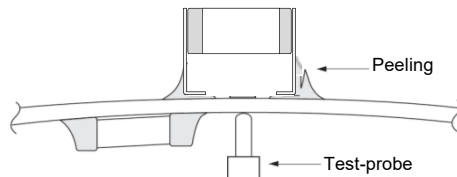

[Recommended]

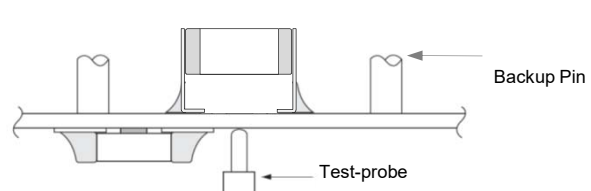

### 7. Printed Circuit Board Cropping

- After mounting a capacitor on a printed circuit board, do not apply any stress to the capacitor that causes bending or twisting the board.
  - In cropping the board, the stress as shown at right may cause the capacitor to crack. Cracked capacitors may cause deterioration of the insulation resistance, and result in a short. Avoid this type of stress to a capacitor.

[Bending]

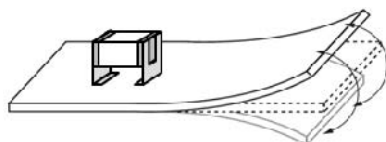

[Twisting]

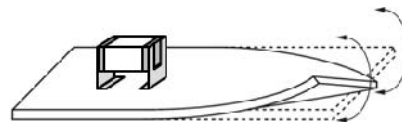

**⚠ Caution**

2. Check the cropping method for the printed circuit board in advance.

2-1. Printed circuit board cropping shall be carried out by using a jig or an apparatus (Disk separator, router type separator, etc.) to prevent the mechanical stress that can occur to the board.

| Board Separation Method  | Hand Separation<br>Nipper Separation   | (1) Board Separation Jig  | Board Separation Apparatus   |                           |
|--------------------------|--|---|--|---------------------------|
|                          |  |   | (2) Disk Separator   | (3) Router Type Separator |
| Level of stress on board | High   | Medium  | Medium   | Low                       |
| Recommended              | ×  | △*  | △*   | ○                         |
| Notes                    | Hand and nipper separation apply a high level of stress. Use another method. | <ul style="list-style-type: none"> <li>Board handling</li> <li>Board bending direction</li> <li>Layout of capacitors</li> </ul> | <ul style="list-style-type: none"> <li>Board handling</li> <li>Layout of slits</li> <li>Design of V groove</li> <li>Arrangement of blades</li> <li>Controlling blade life</li> </ul> | Board handling            |

\* When a board separation jig or disk separator is used, if the following precautions are not observed, a large board deflection stress will occur and the capacitors may crack. Use router type separator if at all possible.

(1) Example of a suitable jig

[In the case of Single-side Mounting]

An outline of the board separation jig is shown as follows. Recommended example: Stress on the component mounting position can be minimized by holding the portion close to the jig, and bend in the direction towards the side where the capacitors are mounted. Not recommended example: The risk of cracks occurring in the capacitors increases due to large stress being applied to the component mounting position, if the portion away from the jig is held and bent in the direction opposite the side where the capacitors are mounted.

[Outline of Jig]

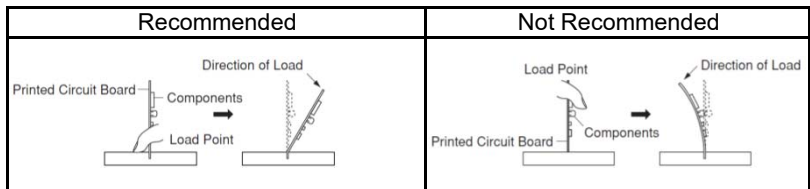
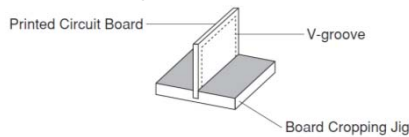

[In the case of Double-sided Mounting]

Since components are mounted on both sides of the board, the risk of cracks occurring can not be avoided with the above method. Therefore, implement the following measures to prevent stress from being applied to the components.

(Measures)

- ① Consider introducing a router type separator. If it is difficult to introduce a router type separator, implement the following measures. (Refer to item 1. Mounting Position)
- ② Mount the components at a right angle to the board separation surface.
- ③ When mounting components near the board separation point, add slits in the separation position near the component.
- ④ Keep the mounting position of the components away from the board separation point.

(2) Example of a Disk Separator

An outline of a disk separator is shown as follows. As shown in the Principle of Operation, the top blade and bottom blade are aligned with the V-grooves on the printed circuit board to separate the board. In the following case, board deflection stress will be applied and cause cracks in the capacitors.

- ① When the adjustment of the top and bottom blades are misaligned, such as deviating in the top-bottom, left-right or front-rear directions
- ② The angle of the V groove is too low, depth of the V groove is too shallow, or the V groove is misaligned top-bottom IF V groove is too deep, it is possible to brake when you handle and carry it. Carefully design depth of the V groove with consideration about strength of material of the printed circuit board.

[Outline of Machine]

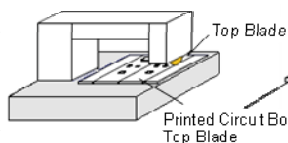

[Principle of Operation]

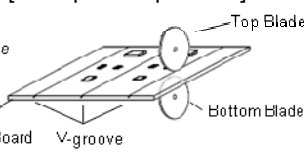



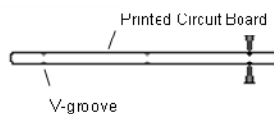

[Cross-section Diagram]

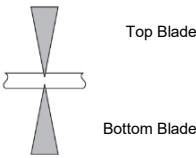
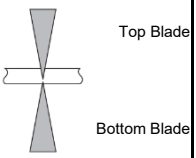
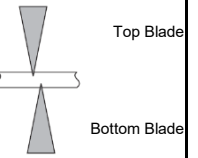
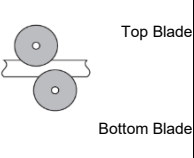

**⚠ Caution**

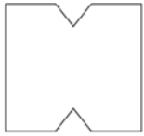
| Recommended  | Not Recommended  |   |  |
|--|--|---|--|
|  | Top-bottom Misalignment  | Left-right Misalignment   | Front-rear Misalignment  |
|  <p>Top Blade</p> <p>Bottom Blade</p> |  <p>Top Blade</p> <p>Bottom Blade</p> |  <p>Top Blade</p> <p>Bottom Blade</p> |  <p>Top Blade</p> <p>Bottom Blade</p> |

| Example of Recommended V-groove Design  | Not Recommended   |   |  |   |
|---|---|---|--|---|
|   | Left-right Misalignment   | Low-Angle   | Depth too Shallow  | Depth too Deep  |
|  |  |  |  |  |

(3) Example of Router Type Separator

The router type separator performs cutting by a router rotating at a high speed. Since the board does not bend in the cutting process, stress on the board can be suppressed during board separation. When attaching or removing boards to/from the router type separator, carefully handle the boards to prevent bending.

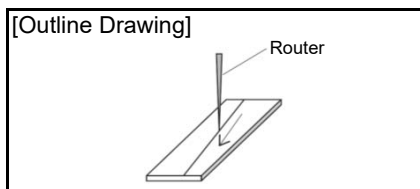

## 8. Assembly

### 1. Handling

If a board mounted with capacitors is held with one hand, the board may bend. Firmly hold the edges of the board with both hands when handling. If a board mounted with capacitors is dropped, cracks may occur in the capacitors.

Do not use dropped boards, as there is a possibility that the quality of the capacitors may be impaired.

### 2. Attachment of Other Components

#### 2-1. Mounting of Other Components

Pay attention to the following items, when mounting other components on the back side of the board after capacitors have been mounted on the opposite side. When the bottom dead point of the suction nozzle is set too low, board deflection stress may be applied to the capacitors on the back side (bottom side), and cracks may occur in the capacitors.

- After the board is straightened, set the bottom dead point of the nozzle on the upper surface of the board.
- Periodically check and adjust the bottom dead point.

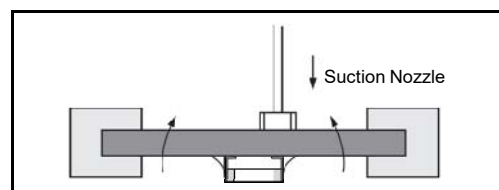

#### 2-2. Inserting Components with Leads into Boards

When inserting components (transformers, IC, etc.) into boards, bending the board may cause cracks in the capacitors or cracks in the solder. Pay attention to the following.

- Increase the size of the holes to insert the leads, to reduce the stress on the board during insertion.
- Fix the board with backup pins or a dedicated jig before insertion.
- Support below the board so that the board does not bend. When using multiple backup pins on the board, periodically confirm that there is no difference in the height of each backup pin.

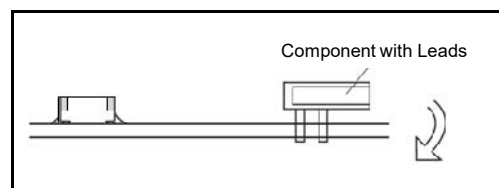



**⚠ Caution****2-3. Attaching/Removing Sockets**

When the board itself is a connector, the board may bend when a socket is attached or removed. Plan the work so that the board does not bend when a socket is attached or removed.

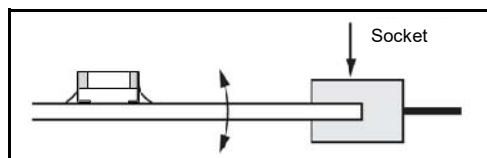
**2-4. Tightening Screws**

The board may be bent, when tightening screws, etc. during the attachment of the board to a shield or chassis.

Pay attention to the following items before performing the work.

- Plan the work to prevent the board from bending.
- Use a torque screwdriver, to prevent over-tightening of the screws.
- The board may bend after mounting by reflow soldering, etc. Please note, as stress may be applied to the chips by forcibly flattening the board when tightening the screws.

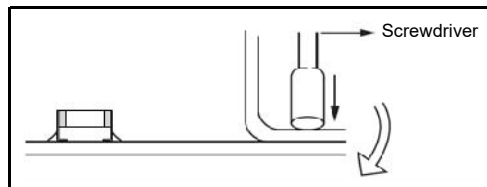
**■ Other****1. Under Operation of Equipment**

- 1-1. Do not touch a capacitor directly with bare hands during operation in order to avoid the danger of an electric shock.
- 1-2. Do not allow the terminals of a capacitor to come in contact with any conductive objects (short-circuit). Do not expose a capacitor to a conductive liquid, including any acid or alkali solutions.
- 1-3. Confirm the environment in which the equipment will operate is under the specified conditions. Do not use the equipment under the following environments.
  - (1) Being splattered with water or oil.
  - (2) Being exposed to direct sunlight.
  - (3) Being exposed to ozone, ultraviolet rays, or radiation.
  - (4) Being exposed to toxic gas (e.g., hydrogen sulfide, sulfur dioxide, chlorine, ammonia gas, etc.)
  - (5) Any vibrations or mechanical shocks exceeding the specified limits.
  - (6) Moisture condensing environments.
- 1-4. Use damp proof countermeasures if using under any conditions that can cause condensation.

**2. Other****2-1. In an Emergency**

- (1) If the equipment should generate smoke, fire, or smell, immediately turn off or unplug the equipment. If the equipment is not turned off or unplugged, the hazards may be worsened by supplying continuous power.
- (2) In this type of situation, do not allow face and hands to come in contact with the capacitor or burns may be caused by the capacitor's high temperature.

**2-2. Disposal of Waste**

When capacitors are disposed of, they must be burned or buried by an industrial waste vendor with the appropriate licenses.

**2-3. Circuit Design**

- (1) Addition of Fail Safe Function
 

Capacitors that are cracked by dropping or bending of the board may cause deterioration of the insulation resistance, and result in a short. If the circuit being used may cause an electrical shock, smoke or fire when a capacitor is shorted, be sure to install fail-safe functions, such as a fuse, to prevent secondary accidents.
- (2) Capacitors used to prevent electromagnetic interference in the primary AC side circuit, or as a connection/insulation, must be a safety standard certified product, or satisfy the contents stipulated in the Electrical Appliance and Material Safety Law. Install a fuse for each line in case of a short.
- (3) The KR3, KRM, KC3, KCM series are not safety standard certified products.

**2-4. Remarks**

Failure to follow the cautions may result, worst case, in a short circuit and smoking when the product is used. The above notices are for standard applications and conditions. Contact us when the products are used in special mounting conditions. Select optimum conditions for operation as they determine the reliability of the product after assembly. The data herein are given in typical values, not guaranteed ratings.

**3. Limitation of applications**

Please contact us before using our products for the applications listed below which require especially high reliability for the prevention of defects which might directly cause damage to the third party's life, body or property.

- (1) Aircraft equipment
- (2) Aerospace equipment
- (3) Undersea equipment
- (4) Power plant control equipment
- (5) Medical equipment
- (6) Transportation equipment (vehicles, trains, ships, etc.)
- (7) Traffic signal equipment
- (8) Disaster prevention/crime prevention equipment
- (9) Data-processing equipment exerting influence on public
- (10) Application of similar complexity and/or reliability requirements to the applications listed in the above.

**Notice**

**Rating**

**1. Operating Temperature**

- 1. The operating temperature limit depends on the capacitor.
  - 1-1. Do not apply temperatures exceeding the upper operating temperature. It is necessary to select a capacitor with a suitable rated temperature that will cover the operating temperature range. It is also necessary to consider the temperature distribution in equipment and the seasonal temperature variable factor.
  - 1-2. Consider the self-heating factor of the capacitor. The surface temperature of the capacitor shall be the upper operating temperature or less when including the self-heating factors.

**2. Atmosphere Surroundings (gaseous and liquid)**

- 1. Restriction on the operating environment of capacitors.
  - 1-1. Capacitors, when used in the above, unsuitable, operating environments may deteriorate due to the corrosion of the terminations and the penetration of moisture into the capacitor.
  - 1-2. The same phenomenon as the above may occur when the electrodes or terminals of the capacitor are subject to moisture condensation.
  - 1-3. The deterioration of characteristics and insulation resistance due to the oxidization or corrosion of terminal electrodes may result in breakdown when the capacitor is exposed to corrosive or volatile gases or solvents for long periods of time.

**3. Piezo-electric Phenomenon**

- 1. When using high dielectric constant type capacitors in AC or pulse circuits, the capacitor itself vibrates at specific frequencies and noise may be generated. Moreover, when the mechanical vibration or shock is added to the capacitor, noise may occur.

**Soldering and Mounting**

**1. PCB Design**

- 1. Notice for Pattern Forms
  - 1-1. Unlike leaded components, chip components are susceptible to flexing stresses since they are mounted directly on the substrate. They are also more sensitive to mechanical and thermal stresses than leaded components. Excess solder fillet height can multiply these stresses and cause chip cracking. When designing substrates, take land patterns and dimensions into consideration to eliminate the possibility of excess solder fillet height.
  - 1-2. There is a possibility of chip cracking caused by PCB expansion/contraction with heat, because stress on a chip is different depending on PCB material and structure. When the thermal expansion coefficient greatly differs between the board used for mounting and the chip, it will cause cracking of the chip due to the thermal expansion and contraction. When small size capacitors of 1005 size or less are mounted on a single-layered glass epoxy board, it will also cause cracking of the chip for the same reason.

Pattern Forms

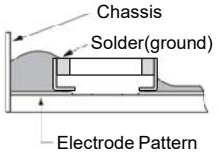
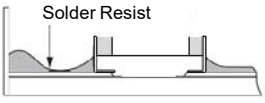
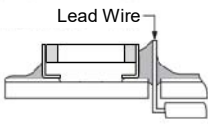
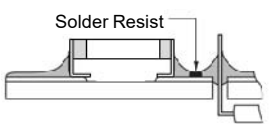
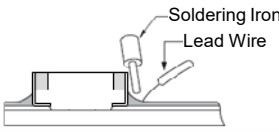
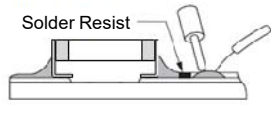
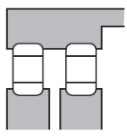
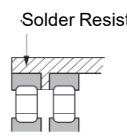
|   | Prohibited  | Correct   |
|---|---|---|
| Placing Close to Chassis                          |  |  |
| Placing of Chip Components and Leaded Components  |  |  |
| Placing of Leaded Components after Chip Component |  |  |
| Lateral Mounting                                  |  |  |

**Notice****2. Land Dimensions**

2-1. Chip capacitors can be cracked due to the stress of PCB bending, etc. if the land area is larger than needed and has an excess amount of solder. Please refer to the land dimensions in the following table for reflow soldering.

Please confirm the suitable land dimension by evaluating of the actual SET / PCB.

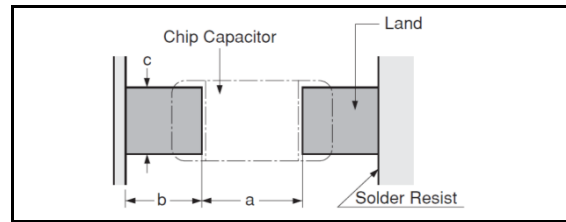

Unit: mm

| Part Number        | Dimensions | Body size (L×W) | a          | b          | c          |
|--------------------|------------|-----------------|------------|------------|------------|
| K□□55□7U□□□□□□DL□□ |            | 6.1×5.1         | 3.2 to 4.0 | 2.0 to 2.4 | 5.5 to 5.7 |

**3. Board Design**

When designing the board, keep in mind that the amount of strain which occurs will increase depending on the size and material of the board.

Relationship with amount of strain to the board thickness, length, width, etc.]

$$\varepsilon = \frac{3PL}{2Ewh^2}$$

Relationship between load and strain

$\varepsilon$  : Strain on center of board ( $\mu\text{st}$ )  
 $L$  : Distance between supporting points (mm)  
 $w$  : Board width (mm)  
 $h$  : Board thickness (mm)  
 $E$  : Elastic modulus of board ( $\text{N/m}^2 = \text{Pa}$ )  
 $Y$  : Deflection (mm)  
 $P$  : Load (N)

When the load is constant, the following relationship can be established.

- As the distance between the supporting points ( $L$ ) increases, the amount of strain also increases.  
→ Reduce the distance between the supporting points.
- As the elastic modulus ( $E$ ) decreases, the amount of strain increases.  
→ Increase the elastic modulus.
- As the board width ( $w$ ) decreases, the amount of strain increases.  
→ Increase the width of the board.
- As the board thickness ( $h$ ) decreases, the amount of strain increases.  
→ Increase the thickness of the board.

Since the board thickness is squared, the effect on the amount of strain becomes even greater.

**4. Washing**

1. Please evaluate the capacitor using actual cleaning equipment and conditions to confirm the quality, and select the solvent for cleaning.
2. Unsuitable cleaning solvent may leave residual flux or other foreign substances, causing deterioration of electrical characteristics and the reliability of the capacitors.
3. Select the proper cleaning conditions.
  - 3-1. Improper cleaning conditions (excessive or insufficient) may result in deterioration of the performance of the capacitors.

**5. Coating**

1. A crack may be cause in the capacitor due to the stress of the thermal contraction of the resin during curing process. The stress is affected by the amount of resin and curing contraction. Select a resin with low curing contraction. The difference in the thermal expansion coefficient between a coating resin or a molding resin and the capacitor may cause the destruction and deterioration of the capacitor such as a crack or peeling, and lead to the deterioration of insulation resistance or dielectric breakdown. Select a resin for which the thermal expansion coefficient is as close to that of the capacitor as possible. A silicone resin can be used as an under-coating to buffer against the stress.
2. Select a resin that is less hygroscopic. Using hygroscopic resins under high humidity conditions may cause the deterioration of the insulation resistance of a capacitor. An epoxy resin can be used as a less hygroscopic resin.

**Notice****■ Other****1. Transportation**

1. The performance of a capacitor may be affected by the conditions during transportation.

1-1. The capacitors shall be protected against excessive temperature, humidity, and mechanical force during transportation.

(1) Climatic condition

- low air temperature : -40°C
- change of temperature air/air : -25°C/+25°C
- low air pressure : 30kPa
- change of air pressure : 6kPa/min.

(2) Mechanical condition

Transportation shall be done in such a way that the boxes are not deformed and forced are not directly passed on to the inner packaging.

1-2. Do not apply excessive vibration, shock, or pressure to the capacitor.

(1) When excessive mechanical shock or pressure is applied to a capacitor, chipping or cracking may occur in the ceramic body of the capacitor.

(2) When the sharp edge of an air driver, a soldering iron, tweezers, a chassis, etc. impacts strongly on the surface of the capacitor, the capacitor may crack and short-circuit.

1-3. Do not use a capacitor to which excessive shock was applied by dropping, etc. A capacitor dropped accidentally during processing may be damaged.

**2. Characteristics Evaluation in the Actual System**

1. Evaluate the capacitor in the actual system, to confirm that there is no problem with the performance and specification values in a finished product before using.

2. Since a voltage dependency and temperature dependency exists in the capacitance of high dielectric type ceramic capacitors, the capacitance may change depending on the operating conditions in the actual system. Therefore, be sure to evaluate the various characteristics, such as the leakage current and noise absorptivity, which will affect the capacitance value of the capacitor.

3. In addition, voltages exceeding the predetermined surge may be applied to the capacitor by the inductance in the actual system. Evaluate the surge resistance in the actual system as required.

**⚠ Note**

1. Please make sure that your product has been evaluated in view of your specifications with our product being mounted to your product.

2. You are requested not to use our product deviating from this specification.

## 1. Application

This specification is applied to Metal Terminal Type Multilayer Ceramic Capacitors KRM series used for General Electronics equipment.

Do not use these products in any automotive power train or safety equipment including battery chargers for electric vehicles and plug-in hybrids.

## 2. Rating

2-1. Operating temperature range -55 to +125°C

## 2-2. Part name configuration

ex.) KRM    55    L    7U    3B    103    J    DL1    K  
 Series    Chip    Height    Temperature    Rated    Capacitance    Capacitance    Individual    Packing  
           dimension    dimension    characteristic    voltage    tolerance    specification    style  
           (L×W)

## •Chip dimension(L×W)

| Code | Nominal Chip dimension (mm) |     |
|------|-----------------------------|-----|
|      | L                           | W   |
| 55   | 5.7                         | 5.0 |

## •Height dimension

| Code | Dimension (mm) |
|------|----------------|
| L    | 2.8            |
| T    | 4.8            |

Please refer to [Part number list] on the dimensions of metal terminal product.

## •Temperature characteristic

| Code | Temperature characteristic |
|------|----------------------------|
| 7U   | U2J                        |

Please confirm detailed specification on [Specification and test methods].

## •Rated voltage

| Code | Rated voltage |
|------|---------------|
| 2J   | DC630V        |
| 3A   | DC1000V       |
| 3B   | DC1250V       |

## •Capacitance

The first two digits denote significant figures ; the last digit denotes the multiplier of 10 in pF.

ex.) In case 103.

$$10 \times 10^3 = 10000\text{pF}$$

## •Capacitance tolerance

Please refer to [Part number list].

## •Individual specification

Murata's control code

Please refer to [ Part number list ].

## •Packing style

| Code | Style                      |
|------|----------------------------|
| K    | φ330mm reel Plastic taping |

## 3. Part number list

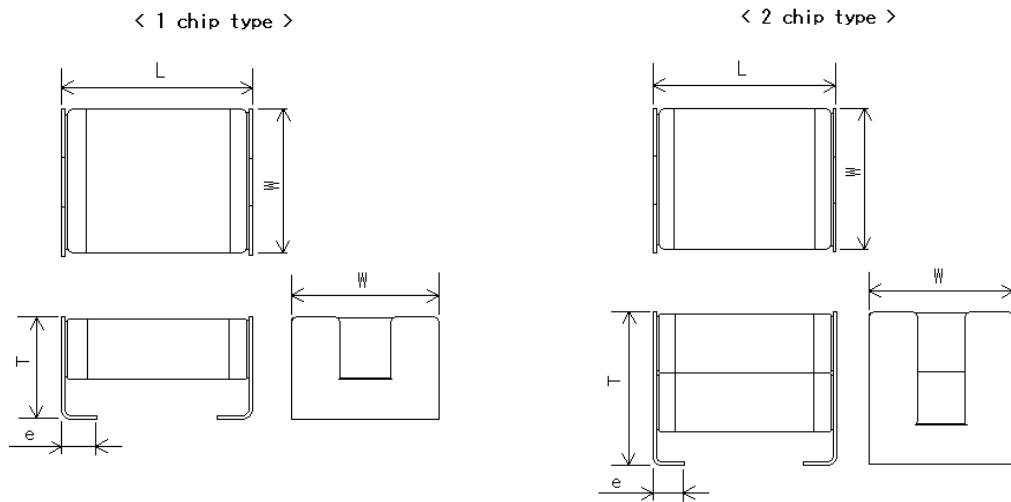

Unit : mm

| T.C. | DC Rated Volt. (V) | Cap. (pF) | Cap. tol. (%) | Customer Part Number | Murata Part Number | Dimension(mm) |             |             |             | Chip type | Pack qty. (pcs) |
|------|--------------------|-----------|---------------|----------------------|--------------------|---------------|-------------|-------------|-------------|-----------|-----------------|
|      |                    |           |               |                      |                    | L             | W           | T           | e           |           |                 |
| U2J  | 630                | 33000     | ±5            |                      | KRM55L7U2J333JDL1  | 6.1<br>±0.4   | 5.1<br>±0.3 | 2.8<br>±0.3 | 0.9<br>±0.2 | 1         | 2000            |
| U2J  | 630                | 39000     | ±5            |                      | KRM55L7U2J393JDL1  | 6.1<br>±0.4   | 5.1<br>±0.3 | 2.8<br>±0.3 | 0.9<br>±0.2 | 1         | 2000            |
| U2J  | 630                | 47000     | ±5            |                      | KRM55L7U2J473JDL1  | 6.1<br>±0.4   | 5.1<br>±0.3 | 2.8<br>±0.3 | 0.9<br>±0.2 | 1         | 2000            |
| U2J  | 630                | 66000     | ±10           |                      | KRM55T7U2J663KDL1  | 6.1<br>±0.4   | 5.1<br>±0.3 | 4.8<br>±0.3 | 0.9<br>±0.2 | 2         | 1000            |
| U2J  | 630                | 78000     | ±10           |                      | KRM55T7U2J783KDL1  | 6.1<br>±0.4   | 5.1<br>±0.3 | 4.8<br>±0.3 | 0.9<br>±0.2 | 2         | 1000            |
| U2J  | 630                | 94000     | ±10           |                      | KRM55T7U2J943KDL1  | 6.1<br>±0.4   | 5.1<br>±0.3 | 4.8<br>±0.3 | 0.9<br>±0.2 | 2         | 1000            |
| U2J  | 1000               | 8200      | ±5            |                      | KRM55L7U3A822JDL1  | 6.1<br>±0.4   | 5.1<br>±0.3 | 2.8<br>±0.3 | 0.9<br>±0.2 | 1         | 2000            |
| U2J  | 1000               | 10000     | ±5            |                      | KRM55L7U3A103JDL1  | 6.1<br>±0.4   | 5.1<br>±0.3 | 2.8<br>±0.3 | 0.9<br>±0.2 | 1         | 2000            |
| U2J  | 1000               | 16000     | ±10           |                      | KRM55T7U3A163KDL1  | 6.1<br>±0.4   | 5.1<br>±0.3 | 4.8<br>±0.3 | 0.9<br>±0.2 | 2         | 1000            |
| U2J  | 1000               | 20000     | ±10           |                      | KRM55T7U3A203KDL1  | 6.1<br>±0.4   | 5.1<br>±0.3 | 4.8<br>±0.3 | 0.9<br>±0.2 | 2         | 1000            |
| U2J  | 1250               | 8200      | ±5            |                      | KRM55L7U3B822JDL1  | 6.1<br>±0.4   | 5.1<br>±0.3 | 2.8<br>±0.3 | 0.9<br>±0.2 | 1         | 2000            |
| U2J  | 1250               | 10000     | ±5            |                      | KRM55L7U3B103JDL1  | 6.1<br>±0.4   | 5.1<br>±0.3 | 2.8<br>±0.3 | 0.9<br>±0.2 | 1         | 2000            |

ETKRM5505

| 4. Specifications and test methods   |   |   |   |                         |                   |                |                           |         |                           |      |                         |      |                         |
|--|---|---|---|-------------------------|-------------------|----------------|---------------------------|---------|---------------------------|------|-------------------------|------|-------------------------|
| No.  | Item                                    | Specifications  | Test method   |                         |                   |                |                           |         |                           |      |                         |      |                         |
| 1  | Operating temperature range             | -55 to +125°C   |   |                         |                   |                |                           |         |                           |      |                         |      |                         |
| 2  | Appearance                              | No defects or abnormalities   | Visual inspection.  |                         |                   |                |                           |         |                           |      |                         |      |                         |
| 3  | Dimensions                              | Within the specified dimension.   | Using calipers and micrometers.   |                         |                   |                |                           |         |                           |      |                         |      |                         |
| 4  | Dielectric strength                     | No defects or abnormalities.  | No failure should be observed when voltage in the table is applied between the terminations for 1 to 5 s, provided the charge/discharge current is less than 50mA.  |                         |                   |                |                           |         |                           |      |                         |      |                         |
|  |   |   | <table border="1"> <thead> <tr> <th>Rated Voltage</th> <th>Test Voltage</th> </tr> </thead> <tbody> <tr> <td>DC630V,DC1000V</td> <td>150% of the rated voltage</td> </tr> <tr> <td>DC1250V</td> <td>120% of the rated voltage</td> </tr> </tbody> </table>  | Rated Voltage           | Test Voltage      | DC630V,DC1000V | 150% of the rated voltage | DC1250V | 120% of the rated voltage |      |                         |      |                         |
| Rated Voltage  | Test Voltage                            |   |   |                         |                   |                |                           |         |                           |      |                         |      |                         |
| DC630V,DC1000V   | 150% of the rated voltage               |   |   |                         |                   |                |                           |         |                           |      |                         |      |                         |
| DC1250V  | 120% of the rated voltage               |   |   |                         |                   |                |                           |         |                           |      |                         |      |                         |
| 5  | Insulation resistance(I.R.)             | More than 10,000MΩ or 100MΩ · μF (Whichever is smaller.)  | The insulation resistance should be measured with DC500±50V and within 60±5 s of charging.<br>Measurement Temperature: Room Temperature   |                         |                   |                |                           |         |                           |      |                         |      |                         |
| 6  | Capacitance                             | Within the specified tolerance.   | The capacitance/Q should be measured at reference temperature at the meaning frequency and voltage shown in the table.  |                         |                   |                |                           |         |                           |      |                         |      |                         |
| 7  | Q                                       | Q ≥ 1000  | <table border="1"> <thead> <tr> <th>Measuring frequency</th> <th>Measuring volgate</th> </tr> </thead> <tbody> <tr> <td>1±0.2kHz</td> <td>AC1.0±0.2V(r.m.s.)</td> </tr> </tbody> </table>   | Measuring frequency     | Measuring volgate | 1±0.2kHz       | AC1.0±0.2V(r.m.s.)        |         |                           |      |                         |      |                         |
|  |   |   | Measuring frequency   | Measuring volgate       |                   |                |                           |         |                           |      |                         |      |                         |
| 1±0.2kHz   | AC1.0±0.2V(r.m.s.)                      |   |   |                         |                   |                |                           |         |                           |      |                         |      |                         |
|  |   |   | Measurement Temperature: Room Temperature   |                         |                   |                |                           |         |                           |      |                         |      |                         |
| 8  | Capacitance Temperature Characteristics | -750±120 ppm/°C (Temp.Range:+25 to +125°C)<br>-750+120/-347 ppm/°C (Temp.Range:-55 to +25°C)  | The capacitance measurement should be made at each step specified in the table.   |                         |                   |                |                           |         |                           |      |                         |      |                         |
|  |   | <table border="1"> <thead> <tr> <th>Step</th> <th>1</th> <th>2</th> <th>3</th> <th>4</th> <th>5</th> </tr> </thead> <tbody> <tr> <td>Temp.(°C)</td> <td>25±2</td> <td>Min. Operating Temp. ±3</td> <td>25±2</td> <td>Max. Operating Temp. ±2</td> <td>25±2</td> </tr> </tbody> </table> | Step  | 1                       | 2                 | 3              | 4                         | 5       | Temp.(°C)                 | 25±2 | Min. Operating Temp. ±3 | 25±2 | Max. Operating Temp. ±2 |
| Step   | 1                                       | 2   | 3   | 4                       | 5                 |                |                           |         |                           |      |                         |      |                         |
| Temp.(°C)  | 25±2                                    | Min. Operating Temp. ±3   | 25±2  | Max. Operating Temp. ±2 | 25±2              |                |                           |         |                           |      |                         |      |                         |
| 9  | Vibration resistance                    | Appearance  | No defects or abnormalities.  |                         |                   |                |                           |         |                           |      |                         |      |                         |
|  |   | Capacitance   | Within the specified tolerance.   |                         |                   |                |                           |         |                           |      |                         |      |                         |
|  |   | Q   | Q ≥ 500   |                         |                   |                |                           |         |                           |      |                         |      |                         |
|  |   |   | Solder the capacitor to the Test Jig A (glass epoxy board) shown in "Complement of test method".<br>The capacitor should be subjected to a simple harmonic motion having a total amplitude of 1.5mm, the frequency being varied uniformly between the approximate limits of 10 and 55Hz .<br>The frequency range, from 10 to 55Hz and return to 10Hz, should be traversed in approximately 1 min.<br>This motion should be applied for a period of 2 h in each of 3 mutually perpendicular directions (total of 6 h). |                         |                   |                |                           |         |                           |      |                         |      |                         |
| 10   | Solderability of termination            | The metal surface is soldered well.   | <p>Reflow Soldering : Peak 260+0/-5°C<br/>The area of soldering 230°C min., 20 to 40 s<br/>Let sit for 24±2 h at room condition*, then measure.</p>   |                         |                   |                |                           |         |                           |      |                         |      |                         |
| * "room condition" Temperature:15 to 35°C, Relative humidity:45 to 75%, Atmosphere pressure:86 to 106kPa |   |   |   |                         |                   |                |                           |         |                           |      |                         |      |                         |

ESKRM5504

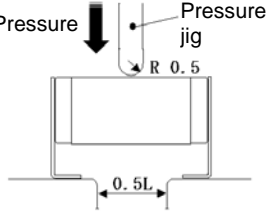
| No.   | Item                             | Specifications   | Test method  |               |              |                 |                           |                              |                           |   |            |        |   |                              |            |   |            |        |
|---|----------------------------------|--|--|---------------|--------------|-----------------|---------------------------|------------------------------|---------------------------|---|------------|--------|---|------------------------------|------------|---|------------|--------|
| 11  | Resistance to soldering heat     | Appearance   | No marking defects.  |               |              |                 |                           |                              |                           |   |            |        |   |                              |            |   |            |        |
|   |                                  | Capacitance change   | Within $\pm 2.5\%$   |               |              |                 |                           |                              |                           |   |            |        |   |                              |            |   |            |        |
|   |                                  | Q  | Pass the item No.7.  |               |              |                 |                           |                              |                           |   |            |        |   |                              |            |   |            |        |
|   |                                  | I.R.   | Pass the item No.5.  |               |              |                 |                           |                              |                           |   |            |        |   |                              |            |   |            |        |
| 12  | Adhesive strength of termination | Dielectric strength  | Pass the item No.4.  |               |              |                 |                           |                              |                           |   |            |        |   |                              |            |   |            |        |
|   |                                  | No removal of the terminations or other defects should occur.  |  |               |              |                 |                           |                              |                           |   |            |        |   |                              |            |   |            |        |
|   |                                  | Solder the capacitor to the Test Jig A (glass epoxy board) shown in "Complement of Test method".<br>Then apply 10N force in the direction of the arrow.  |  |               |              |                 |                           |                              |                           |   |            |        |   |                              |            |   |            |        |
|   |                                  |   |  |               |              |                 |                           |                              |                           |   |            |        |   |                              |            |   |            |        |
| 13  | Deflection                       | No marking defects.  | Solder the capacitor to the Test Jig B (glass epoxy board) shown in "Complement of test method".<br>Then apply the force in the direction shown in "Test Method of Deflection" of "Complement of test method".<br>· Flexure : 5mm<br>· Hold time : 5 s |               |              |                 |                           |                              |                           |   |            |        |   |                              |            |   |            |        |
| 14  | Strength of metal terminal       | Termination not to be broken or loosened.  | A static load of 10N using a pressure jig should be applied to the center in the direction of the arrow and held for 10 s.<br>                                     |               |              |                 |                           |                              |                           |   |            |        |   |                              |            |   |            |        |
| 15  | Temperature cycle                | Appearance   | No marking defects.  |               |              |                 |                           |                              |                           |   |            |        |   |                              |            |   |            |        |
|   |                                  | Capacitance change   | Within $\pm 2.5\%$   |               |              |                 |                           |                              |                           |   |            |        |   |                              |            |   |            |        |
|   |                                  | Q  | $Q \geq 500$   |               |              |                 |                           |                              |                           |   |            |        |   |                              |            |   |            |        |
|   |                                  | I.R.   | Pass the item No.5.  |               |              |                 |                           |                              |                           |   |            |        |   |                              |            |   |            |        |
| 16  | Humidity (Steady state)          | Dielectric strength  | Pass the item No.4.  |               |              |                 |                           |                              |                           |   |            |        |   |                              |            |   |            |        |
|   |                                  | Fix the capacitor to the supporting Test Jig A (glass epoxy board) shown in "Complement of test method".<br>Perform the 100 cycles according to the 4 heat treatments listed in the following table.   |  |               |              |                 |                           |                              |                           |   |            |        |   |                              |            |   |            |        |
|   |                                  | <table border="1"> <thead> <tr> <th>Step</th> <th>Temp. (°C)</th> <th>Time (min)</th> </tr> </thead> <tbody> <tr> <td>1</td> <td>Min. Operating Temp. <math>\pm 3</math></td> <td>30 <math>\pm</math> 3</td> </tr> <tr> <td>2</td> <td>Room Temp.</td> <td>2 to 3</td> </tr> <tr> <td>3</td> <td>Max. Operating Temp. <math>\pm 2</math></td> <td>30 <math>\pm</math> 3</td> </tr> <tr> <td>4</td> <td>Room Temp.</td> <td>2 to 3</td> </tr> </tbody> </table> |  | Step          | Temp. (°C)   | Time (min)      | 1                         | Min. Operating Temp. $\pm 3$ | 30 $\pm$ 3                | 2 | Room Temp. | 2 to 3 | 3 | Max. Operating Temp. $\pm 2$ | 30 $\pm$ 3 | 4 | Room Temp. | 2 to 3 |
|   |                                  | Step   | Temp. (°C)   | Time (min)    |              |                 |                           |                              |                           |   |            |        |   |                              |            |   |            |        |
| 1   | Min. Operating Temp. $\pm 3$     | 30 $\pm$ 3   |  |               |              |                 |                           |                              |                           |   |            |        |   |                              |            |   |            |        |
| 2   | Room Temp.                       | 2 to 3   |  |               |              |                 |                           |                              |                           |   |            |        |   |                              |            |   |            |        |
| 3   | Max. Operating Temp. $\pm 2$     | 30 $\pm$ 3   |  |               |              |                 |                           |                              |                           |   |            |        |   |                              |            |   |            |        |
| 4   | Room Temp.                       | 2 to 3   |  |               |              |                 |                           |                              |                           |   |            |        |   |                              |            |   |            |        |
| Let sit for 24 $\pm$ 2 h at room condition*, then measure.  |                                  |  |  |               |              |                 |                           |                              |                           |   |            |        |   |                              |            |   |            |        |
| 17  | Life                             | Appearance   | No marking defects.  |               |              |                 |                           |                              |                           |   |            |        |   |                              |            |   |            |        |
|   |                                  | Capacitance change   | Within $\pm 3.0\%$   |               |              |                 |                           |                              |                           |   |            |        |   |                              |            |   |            |        |
|   |                                  | Q  | $Q \geq 350$   |               |              |                 |                           |                              |                           |   |            |        |   |                              |            |   |            |        |
|   |                                  | I.R.   | More than 1000M $\Omega$ or 10M $\Omega$ · $\mu$ F (Whichever is smaller.)   |               |              |                 |                           |                              |                           |   |            |        |   |                              |            |   |            |        |
| 17  | Life                             | Dielectric strength  | Pass the item No.4.  |               |              |                 |                           |                              |                           |   |            |        |   |                              |            |   |            |        |
|   |                                  | Apply voltage DC945V for 1000+48/-0 h at maximum operating temperature $\pm 3^\circ$ C.<br>Remove and let sit for 24 $\pm$ 2 h at room condition*, then measure.   |  |               |              |                 |                           |                              |                           |   |            |        |   |                              |            |   |            |        |
|   |                                  | The charge/discharge current is less than 50mA.  |  |               |              |                 |                           |                              |                           |   |            |        |   |                              |            |   |            |        |
|   |                                  | <table border="1"> <thead> <tr> <th>Rated Voltage</th> <th>Test Voltage</th> </tr> </thead> <tbody> <tr> <td>DC630V, DC1000V</td> <td>120% of the rated voltage</td> </tr> <tr> <td>DC1250V</td> <td>100% of the rated voltage</td> </tr> </tbody> </table>  |  | Rated Voltage | Test Voltage | DC630V, DC1000V | 120% of the rated voltage | DC1250V                      | 100% of the rated voltage |   |            |        |   |                              |            |   |            |        |
| Rated Voltage   | Test Voltage                     |  |  |               |              |                 |                           |                              |                           |   |            |        |   |                              |            |   |            |        |
| DC630V, DC1000V   | 120% of the rated voltage        |  |  |               |              |                 |                           |                              |                           |   |            |        |   |                              |            |   |            |        |
| DC1250V   | 100% of the rated voltage        |  |  |               |              |                 |                           |                              |                           |   |            |        |   |                              |            |   |            |        |
| * "room condition" Temperature: 15 to 35°C, Relative humidity: 45 to 75%, Atmosphere pressure: 86 to 106kPa |                                  |  |  |               |              |                 |                           |                              |                           |   |            |        |   |                              |            |   |            |        |



Complement of Test Method

Test Jig

The test jig should be Jig A or Jig B as described in "Specifications and Test methods".

The specimen should be soldered by the conditions as described below.

Soldering Method : Reflow soldering

Thickness of Metal-mask : 200 $\mu$ m

Solder : Sn-3.0Ag-0.5Cu

(1) Test Jig A

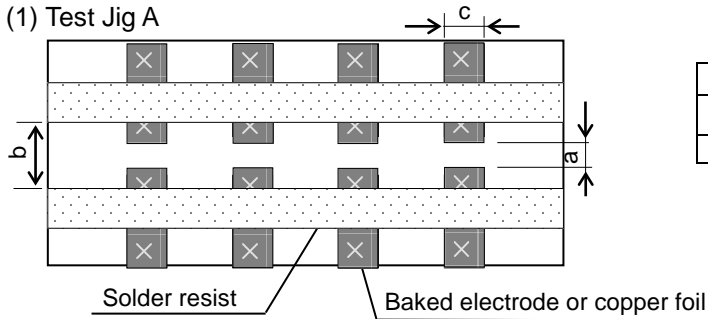

| Dimension (mm) |     |     |
|----------------|-----|-----|
| a              | b   | c   |
| 4.0            | 8.0 | 5.6 |

- Material : Glass Epoxy Board
- Thickness : 1.6mm
- Thickness of copper foil : 0.035mm

(2) Test Jig B

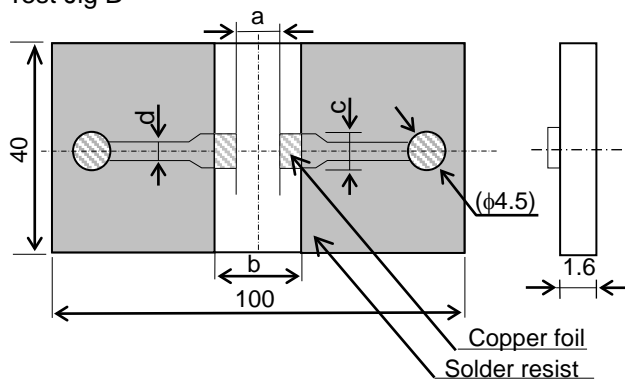

| Dimension (mm) |     |     |     |
|----------------|-----|-----|-----|
| a              | b   | c   | d   |
| 4.5            | 8.0 | 5.6 | 1.0 |

(unit : mm)

- Material : Glass Epoxy Board
- Thickness of copper foil : 0.035mm

5. Packing (Taping is standard packing method)

(1) Appearance of taping

(a) Plastic Tape

Cover Tape (Thickness: Around 60 $\mu$ m) is put on capacitor on Base Tape (Blister carrier Tape).

(b) The sprocket holes are to the right as the Tape is pulled toward the user.

(2) Packed capacitors

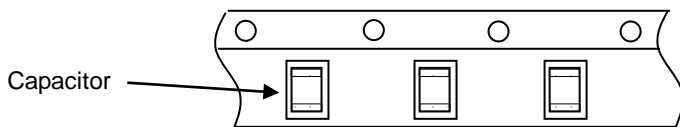

(3) Dimensions of Tape

(a) Height dimension code : L, Q, R, T

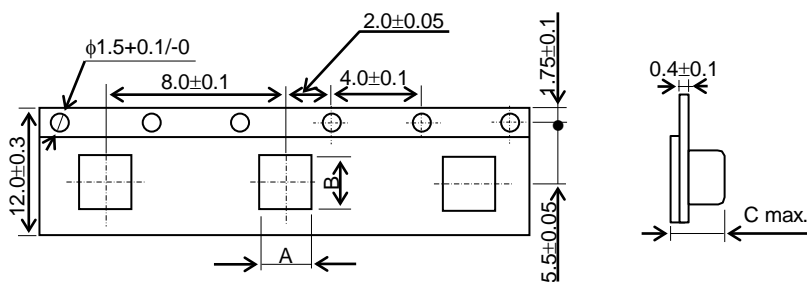

Nominal value

| Part Number | A   | B   | C   |
|-------------|-----|-----|-----|
| K□□55L      | 5.5 | 6.4 | 4.1 |
| K□□55Q      | 5.5 | 6.4 | 5.8 |
| K□□55R      | 5.5 | 6.4 | 5.8 |
| K□□55T      | 5.5 | 6.4 | 5.8 |

(Unit : mm)

(b) Height dimension code : V, W

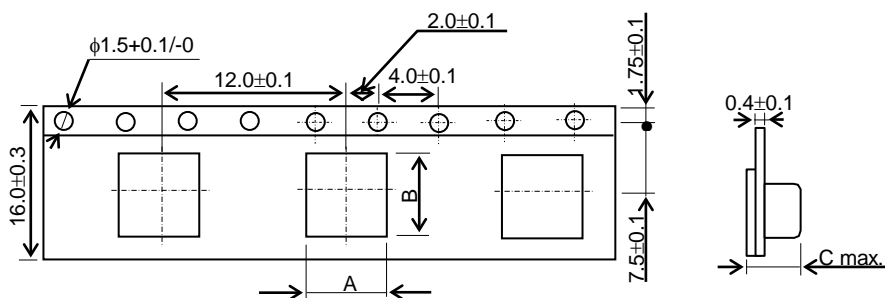

Nominal value

| Part Number | A   | B   | C   |
|-------------|-----|-----|-----|
| K□□55V      | 5.7 | 6.7 | 7.4 |
| K□□55W      | 5.7 | 6.7 | 7.4 |

(Unit : mm)

(4) Dimensions of Reel

(a) Height dimension code : L, Q, R, T

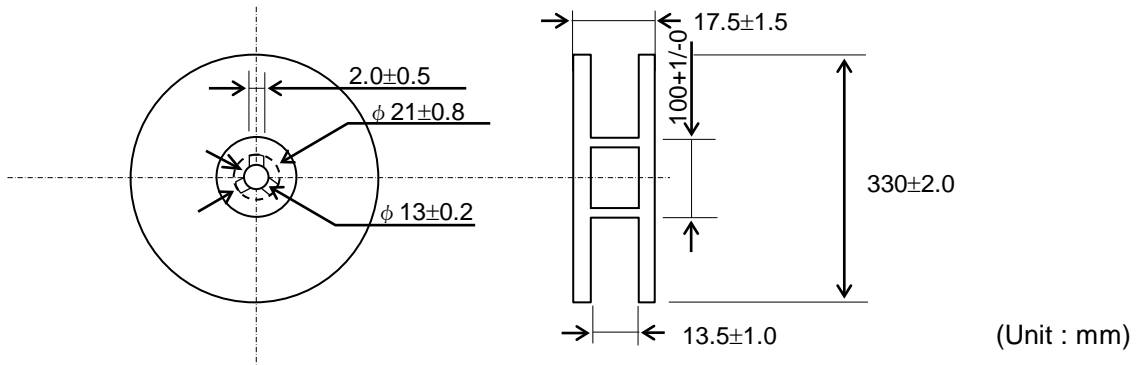

(b) Height dimension code : V, W

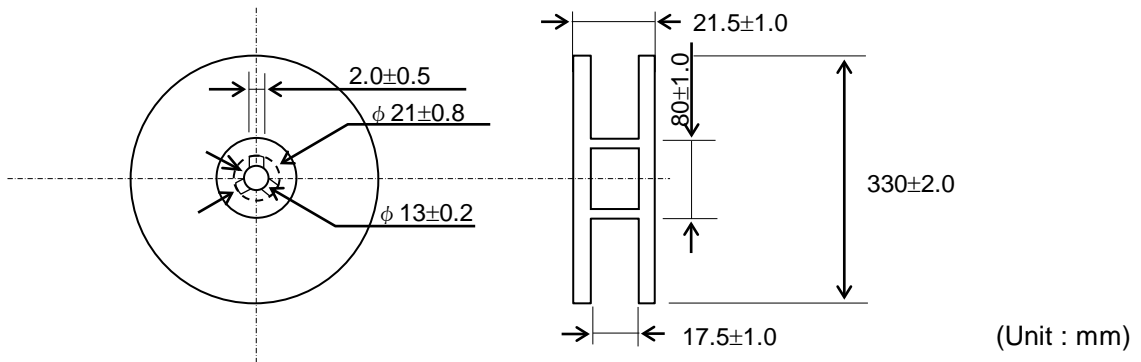

(5) Part of the leader and part of the empty tape should be attached to the end of the tape as follows.

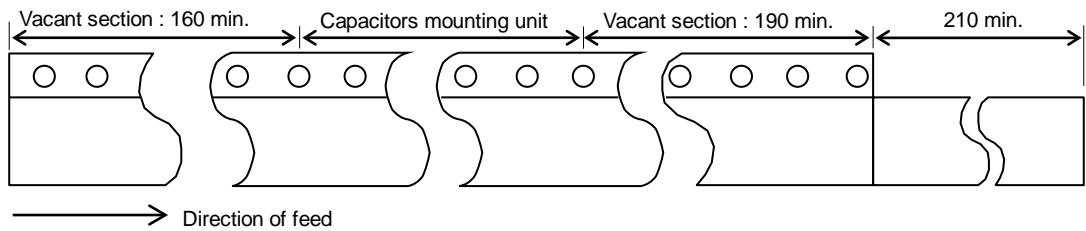

(Unit : mm)

(6) The top tape or cover tape and base tape are not attached at the end of the tape for a minimum of 5 pitches.

(7) Missing capacitors number within 0.1% of the number per reel or 1pc, whichever is greater, and not continuous

(8) The top tape or cover tape and bottom tape should not protrude beyond the edges of the tape and should not cover sprocket holes.

(9) Cumulative tolerance of sprocket holes, 10 pitches :  $\pm 0.3\text{mm}$ .

(10) Peeling off force : 0.1 to 0.6N in the direction shown on the follows.



# Mouser Electronics

Authorized Distributor

Click to View Pricing, Inventory, Delivery & Lifecycle Information:

## Murata:

[KRM55T7U3A203KDL1L](#) [KRM55T7U2J783KDL1L](#) [KRM55T7U2J943KDL1K](#) [KRM55T7U2J943KDL1L](#)  
[KRM55T7U3A163KDL1K](#) [KRM55T7U3A163KDL1L](#) [KRM55T7U3A203KDL1K](#) [KRM55L7U3B103JDL1L](#)  
[KRM55L7U3B822JDL1K](#) [KRM55L7U3B822JDL1L](#) [KRM55T7U2J663KDL1K](#) [KRM55T7U2J663KDL1L](#)  
[KRM55T7U2J783KDL1K](#) [KRM55L7U2J473JDL1L](#) [KRM55L7U3A103JDL1K](#) [KRM55L7U3A103JDL1L](#)  
[KRM55L7U3A822JDL1K](#) [KRM55L7U3A822JDL1L](#) [KRM55L7U3B103JDL1K](#) [KRM55L7U2J333JDL1K](#)  
[KRM55L7U2J333JDL1L](#) [KRM55L7U2J393JDL1K](#) [KRM55L7U2J393JDL1L](#) [KRM55L7U2J473JDL1K](#)