

# STAR LED Heat Sinks



## Features & Benefits

- » Designed for high-performance convection cooling of high heat flux LEDs
- » Heat Sinks available with and without base plates for easy LED mounting
- » Each STAR series heat sink is made from lightweight, anodized aluminum for maximum thermal performance



PART #	DIAMETER (A)	HS LENGTH (B)	BASE PLATE THICKNESS	BASE PLATE OUTER THREAD	FINISH	THERMAL PERFORMANCE
ATSEU-077A2-C1-R1	45 mm	68 mm	7 mm	UNTHREADED	BLACK	45 mm: CURVE 1
ATSEU-077A2-C2-R0	45 mm	68 mm	7 mm	M43x1.5	BLACK	45 mm: CURVE 1
ATSEU-077A2-C5-R0	45 mm	68 mm	NONE	NONE	BLACK	45 mm: CURVE 1
ATSEU-077A-C3-R0	45 mm	68 mm	7 mm	UNTHREADED	BLACK/SILVER TIP	45 mm: CURVE 1
ATSEU-077A-C4-R0	45 mm	68 mm	7 mm	M43x1.5	BLACK/SILVER TIP	45 mm: CURVE 1
ATSEU-077A-C6-R0	45 mm	68 mm	NONE	NONE	BLACK/SILVER TIP	45 mm: CURVE 1
ATSEU-077B-C1-R0	45 mm	43 mm	7 mm	UNTHREADED	BLACK	45 mm: CURVE 2
ATSEU-077B-C2-R0	45 mm	43 mm	7 mm	M43x1.5	BLACK	45 mm: CURVE 2
ATSEU-077B-C5-R0	45 mm	43 mm	NONE	NONE	BLACK	45 mm: CURVE 2
ATSEU-077B-C3-R0	45 mm	43 mm	7 mm	UNTHREADED	BLACK/SILVER TIP	45 mm: CURVE 2
ATSEU-077B-C4-R0	45 mm	43 mm	7 mm	M43x1.5	BLACK/SILVER TIP	45 mm: CURVE 2
ATSEU-077B-C6-R0	45 mm	43 mm	NONE	NONE	BLACK/SILVER TIP	45 mm: CURVE 2
ATSEU-077D-C1-R0	45 mm	38 mm	7 mm	UNTHREADED	BLACK	45 mm: CURVE 3
ATSEU-077D-C2-R0	45 mm	38 mm	7 mm	M43x1.5	BLACK	45 mm: CURVE 3
ATSEU-077D-C5-R0	45 mm	38 mm	NONE	NONE	BLACK	45 mm: CURVE 3
ATSEU-077D-C3-R0	45 mm	38 mm	7 mm	UNTHREADED	BLACK/SILVER TIP	45 mm: CURVE 3
ATSEU-077D-C4-R0	45 mm	38 mm	7 mm	M43x1.5	BLACK/SILVER TIP	45 mm: CURVE 3
ATSEU-077D-C6-R0	45 mm	38 mm	NONE	NONE	BLACK/SILVER	45 mm: CURVE 3
ATSEU-077C-C1-R0	45 mm	18 mm	7 mm	UNTHREADED	BLACK	45 mm: CURVE 4
ATSEU-077C-C2-R0	45 mm	18 mm	7 mm	M43x1.5	BLACK	45 mm: CURVE 4
ATSEU-077C-C5-R0	45 mm	18 mm	NONE	NONE	BLACK	45 mm: CURVE 4
ATSEU-077C-C3-R0	45 mm	18 mm	7 mm	UNTHREADED	BLACK/SILVER TIP	45 mm: CURVE 4
ATSEU-077C-C4-R0	45 mm	18 mm	7 mm	M43x1.5	BLACK/SILVER TIP	45 mm: CURVE 4
ATSEU-077C-C6-R0	45 mm	18 mm	NONE	NONE	BLACK/SILVER TIP	45 mm: CURVE 4
ATSEU-109-C1-R0	60 mm	60 mm	10 mm	M59x1.5	BLACK	60 mm CURVE
ATSEU-109-C2-R0	60 mm	60 mm	NONE	NONE	BLACK	60 mm CURVE
ATSEU-110-C1-R0	100 mm	85 mm	10 mm	M101x1.0	BLACK	100 mm CURVE
ATSEU-110-C2-R0	100 mm	85 mm	NONE	NONE	BLACK	100 mm CURVE

## NOTES:

- 1) Thermal Performance data are provided for reference only - Actual performance may vary by application
- 2) ATS reserves the right to update or change its products without notice
- 3) Contact ATS to learn about custom options available



**ATS** ADVANCED THERMAL SOLUTIONS, INC.  
Innovations in Thermal Management®

For more information, to find a distributor or to place an order, visit [www.qats.com](http://www.qats.com)

# STAR LED Heat Sinks



Extrusion and custom lengths are also available for any STAR profile.

## Thermal Performance

45 mm Diameter Heat Sinks

60 mm Diameter Heat Sinks

100 mm Diameter Heat Sinks



## Schematic

45 mm Diameter Heat Sinks

60 mm Diameter Heat Sinks

100 mm Diameter Heat Sinks

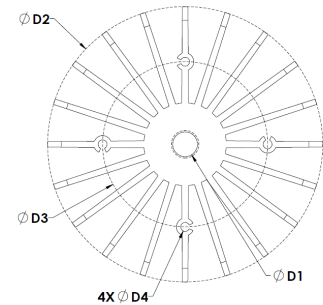
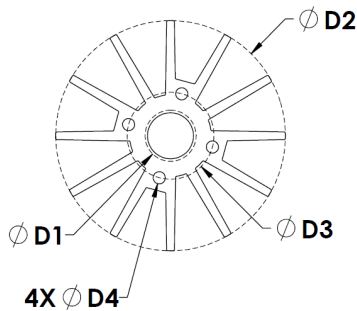

## Image

45 mm Diameter Heat Sinks

60 mm Diameter & 100 mm Diameter Heat Sinks



FOR ILLUSTRATION PURPOSES ONLY



D1	D2	D3	D4
9 mm THRU / M10 I 15 mm	100 mm	60 mm	3.26 mm
9 mm THRU / M10 I 15 mm	60 mm	30 mm	3.26 mm
9 mm THRU / M10 I 15 mm	45 mm	17 mm	2.38 mm

For more information, to find a distributor or to place an order, visit [www.qats.com](http://www.qats.com)

# Mouser Electronics

Authorized Distributor

Click to View Pricing, Inventory, Delivery & Lifecycle Information:

[Advanced Thermal Solutions:](#)

[ATSEU-077D-C5-R0](#)