

SAW Bandpass Filter F1G52



Features

- GPS applications
- Usable bandwidth of 2 MHz
- No impedance matching require for operation at 50 Ω
- SMD Package 2.5 mm × 2.0 mm × 1.0 mm
- Single-ended Operation

Package Dimensions

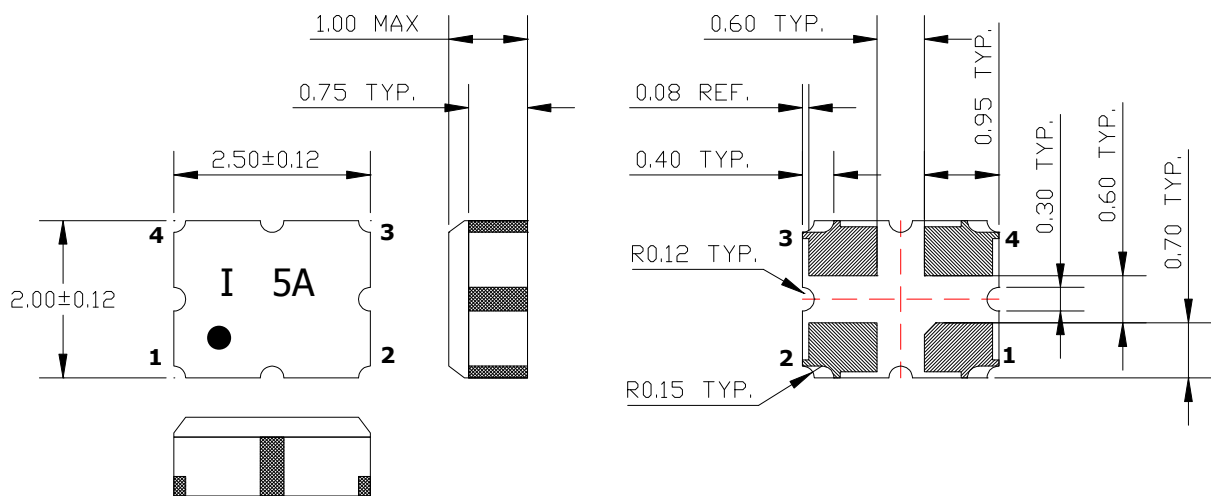

Dimensions shown are nominal in millimeters

Body : Al₂O₃ Ceramic

Lid : Kovar, Ni Plated

Terminations : Au plating 0.5 ~ 1.0 μm, Over a 2.0 ~ 6.0 μm
Ni Plating

Pin Configuration

1	Input
3	Output
2, 4	Ground

Maximum Ratings

Parameter	Unit	Minimum	Typical	Maximum
Operating Temperature Range	°C	-40	25	95
Storage Temperature Range	°C	-40	-	105
Power Handling Capability	dBm	-	10	-

Electrostatics Sensitive Device (ESD)

	ITF Co., Ltd. 102-901, Bucheon Technopark 364, Samjeong-Dong, Ojeong-Gu, Bucheon-City, Gyeonggi-Do, Korea 421-809	Part No.	F1G52	
		Rev. Date	2007-10-16	
		Rev.	NG4003-AS03	1/7

SAW Bandpass Filter F1G52



Specifications

$F_c = 1575.42\text{MHz}$

Terminating source impedance : 50Ω

Terminating load impedance : 50Ω

		Minimum	Typical	Maximum
Center Frequency	MHz	-	1575.42	-
Insertion Loss ($F_o \pm 1\text{ MHz}$)	dB	-	1.5	2.2
Amplitude Ripple ($F_o \pm 1\text{ MHz}$)	dB p-p	-	0.1	1.0
Relative Attenuation				
D.C. ~ 1400 MHz		35.0	37.0	-
1400 ~ 1475 MHz		30.0	34.0	-
1475 ~ 1525 MHz	dB	25.0	37.0	-
1625 ~ 1640 MHz		30.0	45.0	-
1640 ~ 2000 MHz		32.0	34.0	-
2000 ~ 3000 MHz		20.0	28.0	-
VSWR (1574.42 ~ 1576.42 MHz)	-	-	1.2	2.0

Notes :

- 1) All specifications are based on the matching schematic shown below, measured by Agilent Network analyzer and full 2 port calibration.
- 2) Electrical margin has been built into the design to account for the variations due to temperature drift and manufacturing tolerances
- 3) All attenuation measurements are measured relative to insertion loss

	ITF Co., Ltd. 102-901, Bucheon Technopark 364, Samjeong-Dong, Ojeong-Gu, Bucheon-City, Gyeonggi-Do, Korea 421-809	Part No.	F1G52	
		Rev. Date	2007-10-16	
		Rev.	NG4003-AS03	2/7

SAW Bandpass Filter F1G52



Matching Schematic

(Actual matching values may vary due to PCB layout and parasitics)

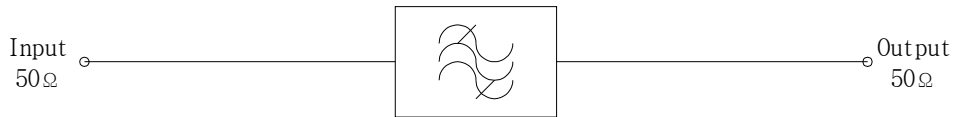

Marking Configuration

I¹⁾ 5A²⁾

● 3)

1) Manufacturer name

2) Marking Number

3) Pad Num 1 Index

	ITF Co., Ltd. 102-901, Bucheon Technopark 364, Samjeong-Dong, Ojeong-Gu, Bucheon-City, Gyeonggi-Do, Korea 421-809	Part No.	F1G52	
		Rev. Date	2007-10-16	
		Rev.	NG4003-AS03	3/7

SAW Bandpass Filter F1G52



Typical Performance (at 25°C)

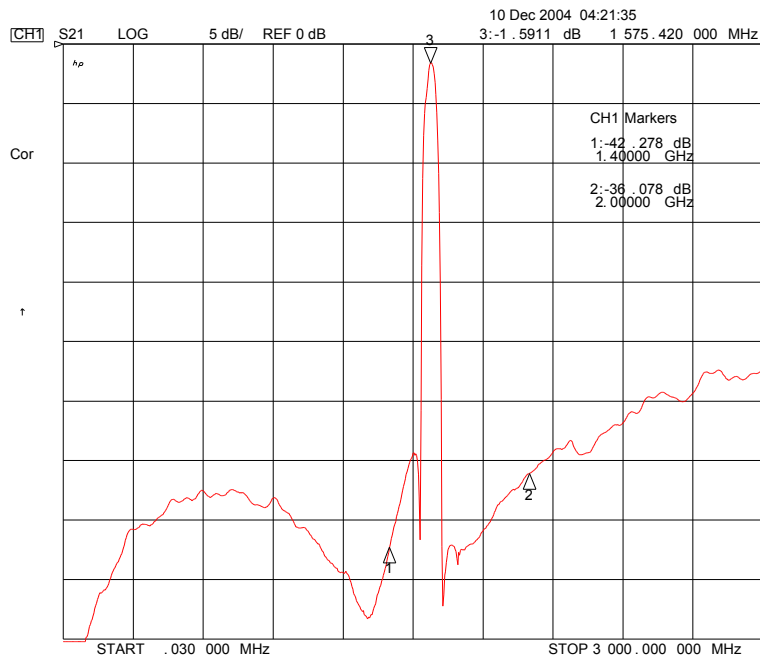
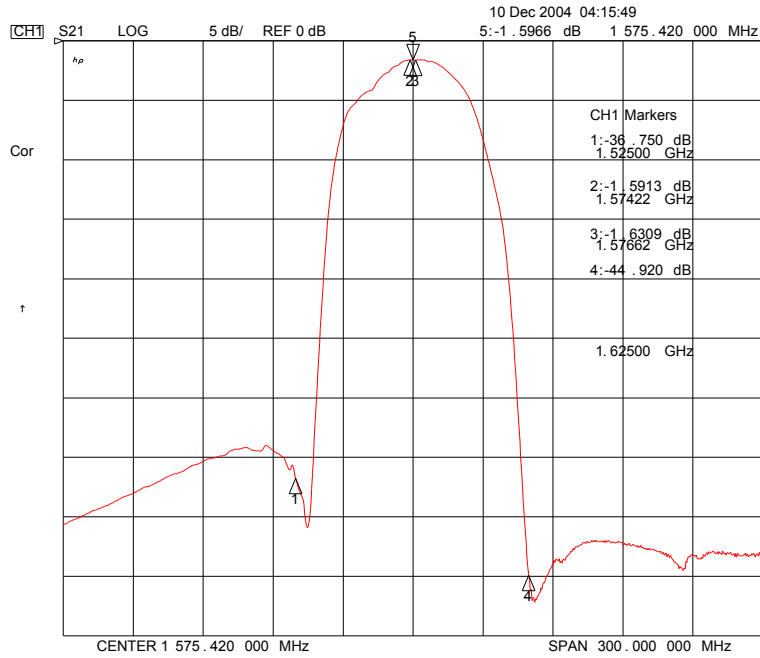

ITF Co., Ltd.
 102-901, Bucheon Technopark 364,
 Samjeong-Dong, Ojeong-Gu, Bucheon-City,
 Gyeonggi-Do, Korea 421-809

Part No.	F1G52	
Rev. Date	2007-10-16	
Rev.	NG4003-AS03	4/7

SAW Bandpass Filter F1G52



Input / Output VSWR Charts

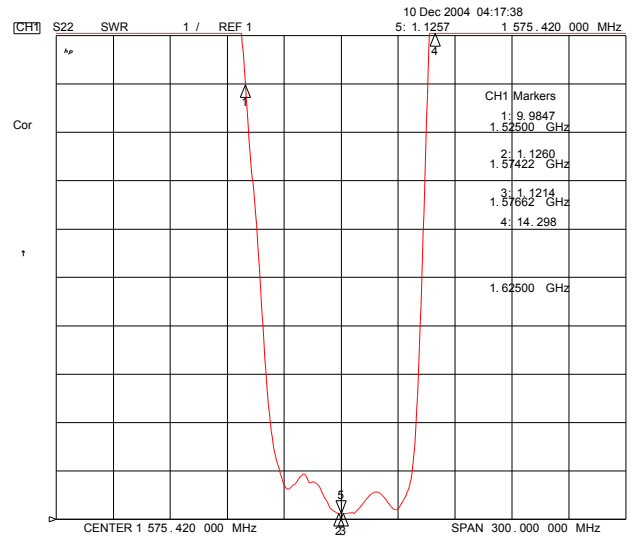
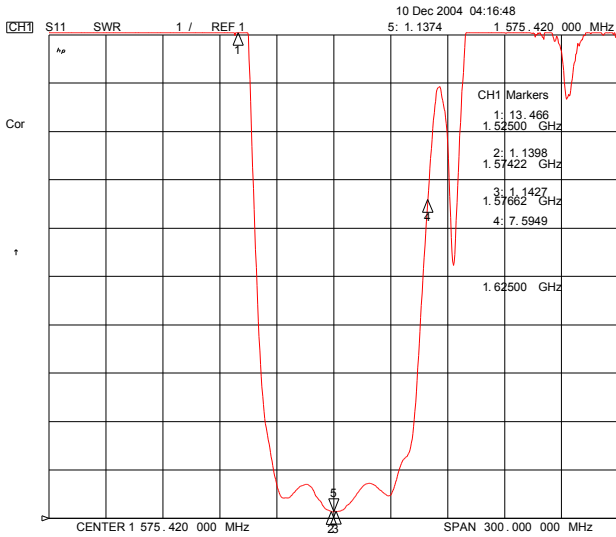

Input / Output Smith Charts

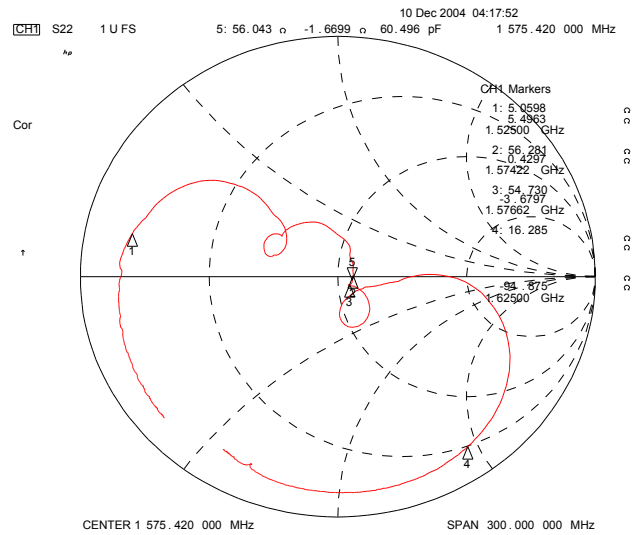
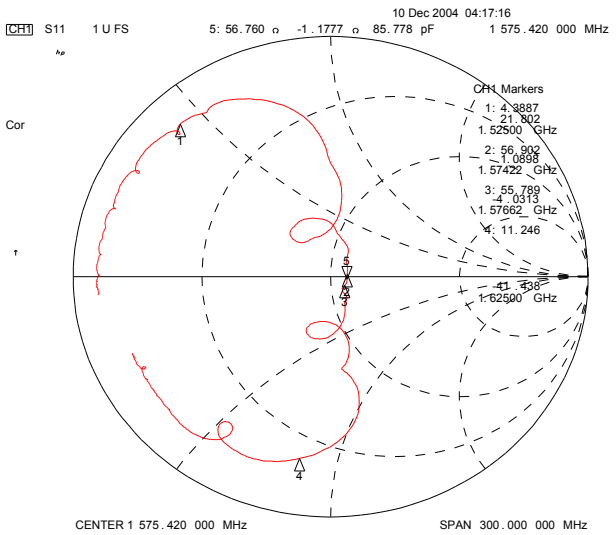

ITF Co., Ltd.
102-901, Bucheon Technopark 364,
Samjeong-Dong, Ojeong-Gu, Bucheon-City,
Gyeonggi-Do, Korea 421-809

Part No.	F1G52	
Rev. Date	2007-10-16	
Rev.	NG4003-AS03	5/7

SAW Bandpass Filter F1G52



Packing Specification

1. Reeling Quantity : 3,000 pcs / reel (or 1,000 pcs / reel, 2,000 pcs / reel)
2. Taping Structure : The tape shall be wound around the reel in the direction shown below.

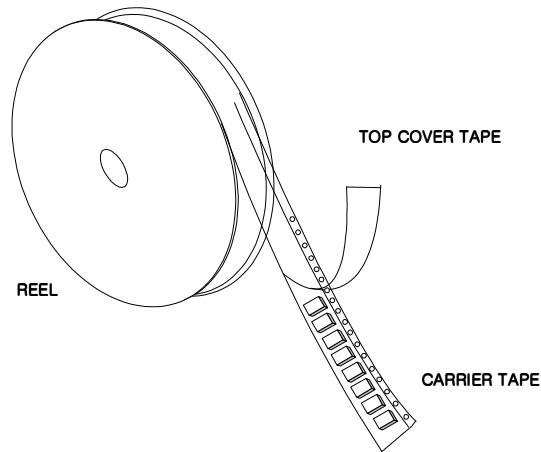

Tape Specification

1. Leader part and vacant position specification

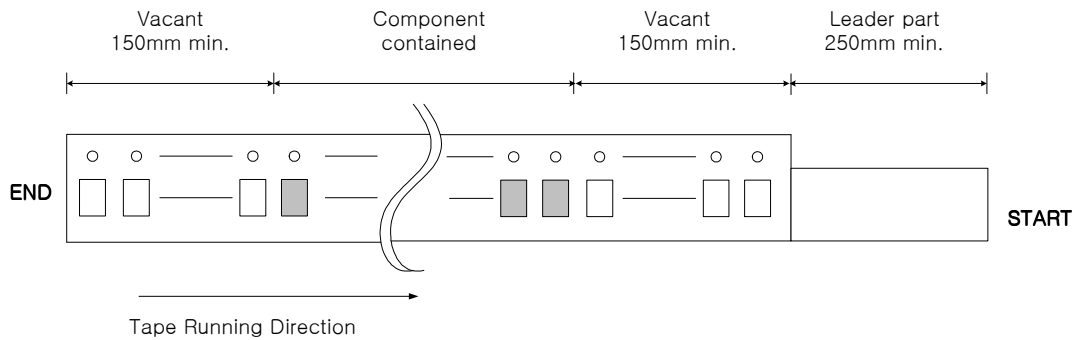

2. Tensile strength of carrier tape

4.4N/mm width

3. Top cover tape adhesion

- 1) pull off angle : 0~15°
- 2) speed : 300mm/min
- 3) force : 20~70g

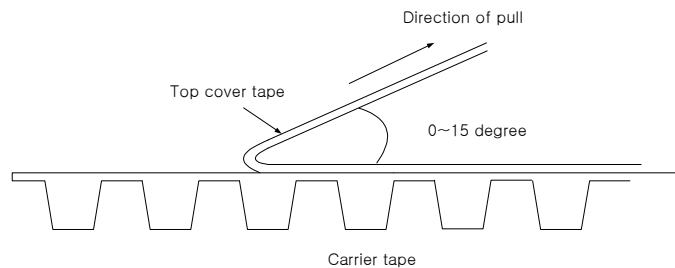

	ITF Co., Ltd. 102-901, Bucheon Technopark 364, Samjeong-Dong, Ojeong-Gu, Bucheon-City, Gyeonggi-Do, Korea 421-809	Part No.	F1G52	
		Rev. Date	2007-10-16	
		Rev.	NG4003-AS03	6/7

SAW Bandpass Filter F1G52



Carrier Tape Dimensions [unit : mm]

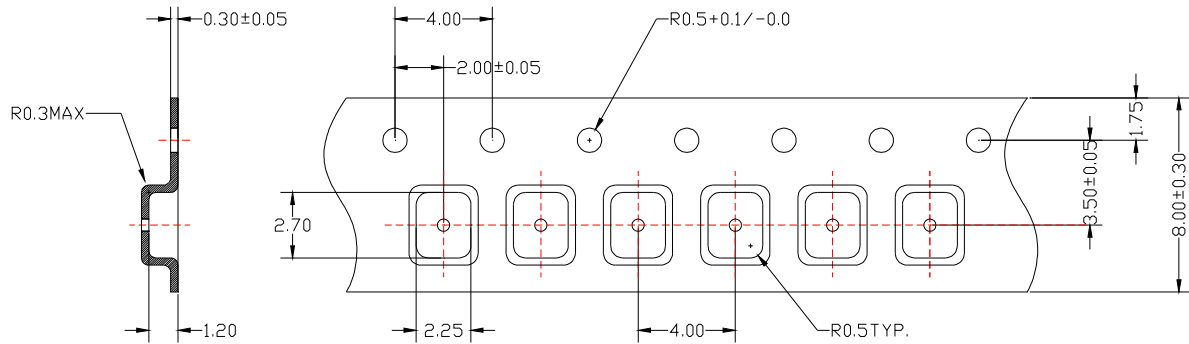

Part Direction

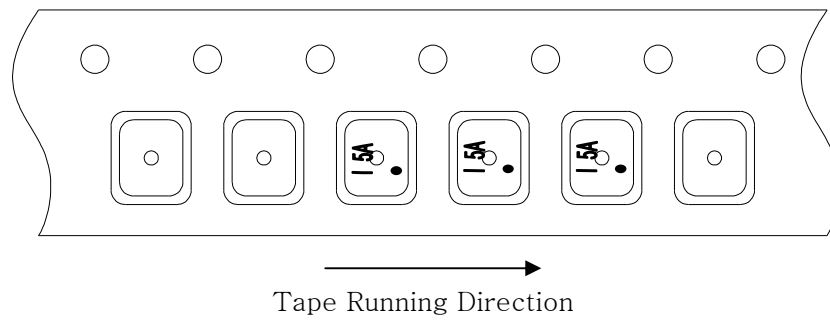

Reel Dimensions [unit : mm]

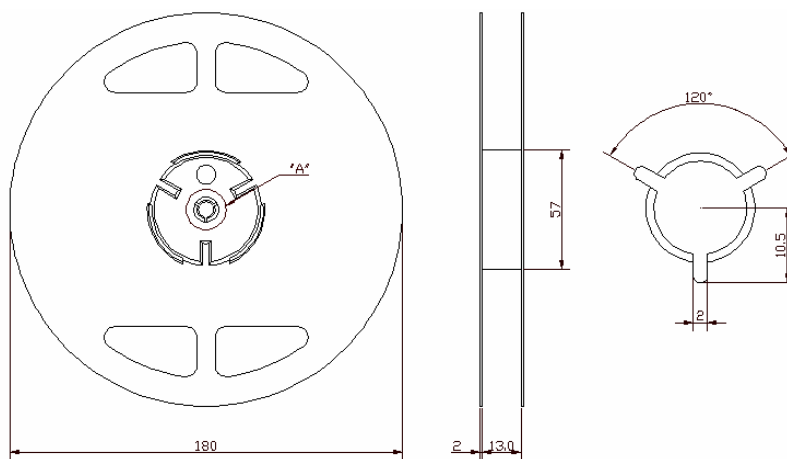

	ITF Co., Ltd. 102-901, Bucheon Technopark 364, Samjeong-Dong, Ojeong-Gu, Bucheon-City, Gyeonggi-Do, Korea 421-809	Part No.	F1G52	
		Rev. Date	2007-10-16	
		Rev.	NG4003-AS03	7/7